

Packaging Guideline for Rental Material

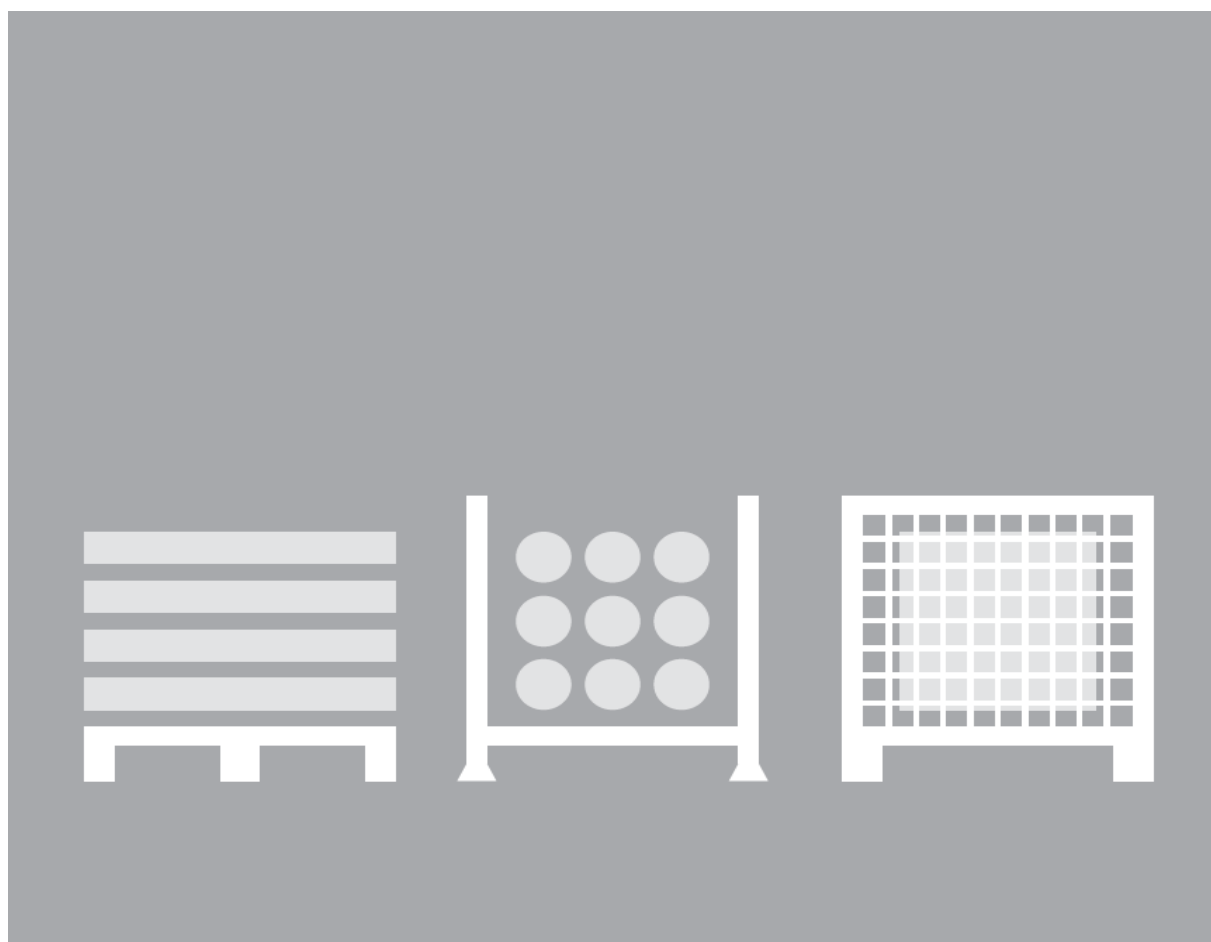

BOX Operations | PERI Holding



06/2025

Content

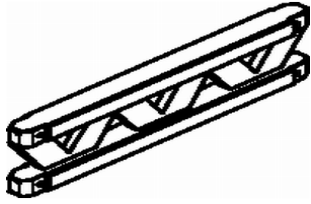
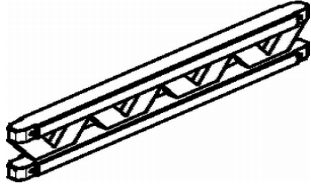
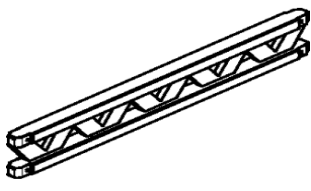
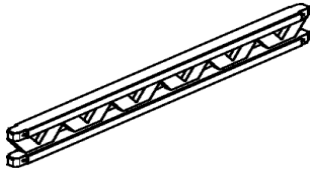
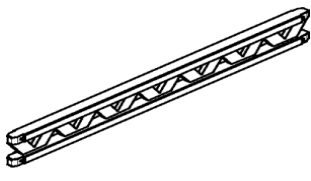
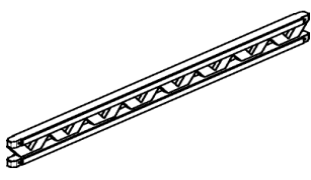
PG	Name	Page
1	GT 24 Formwork Girder	1
2	VT 20 Formwork Girder	4
3	VARIO GT 24 Girder Wall Formwork + FTF	6
4	Road Construction (HD, SLS, GKB)	13
5	Waler Systems	40
7	Table Systems	49
8	VARIO System Couplings	52
9	VARIO Accessories	54
10	Push-Pull Props	60
11	Climbing Brackets	65
12	SB Brace Frame	81
13	Climbing Systems	91
14	RUNDFLEX Circular Formwork	122
15	PD 8 Shoring	132
16	ST 100 Stacking Tower	138
17	Column Formwork	142
18	GRIDFLEX Slab Formwork	147
20	Slab Props	149
21	Slab Formwork	167
23	SRS Circular Column Formwork	177
24	DOMINO Panel Formwork	182
26	MAXIMO Panel Formwork	195
27	TRIO Panel Formwork	219
28	HANDSET / LIWA Panel Formwork	240
29	DUO Polymer Formwork	255
31	PROKIT Safety System	260
32	Building Equipment + Packaging Systems	263
33	PERI UP	267
35	Accessories Climbing Brackets	351
36	Tie Systems	353

Article No.	Article Name	Article Image
375100	Girder GT 24, l = 0.90 m	
amount	50	
load carrier	euro pallet	
packaging method	5 wide, 12 up	
packaging aid	steel strap, edge protection	
375120	Girder GT 24, l = 1.20 m	
amount	50	
load carrier	euro pallet	
packaging method	5 wide, 12 up	
packaging aid	steel strap, edge protection	
375150	Girder GT 24, l = 1.50 m	
amount	50	
load carrier	bundle	
packaging method	5 wide, 12 up	
packaging aid	steel strap, dunnage, edge protection	
375180	Girder GT 24, l = 1.80 m	
amount	50	
load carrier	bundle	
packaging method	5 wide, 12 up	
packaging aid	steel strap, dunnage, edge protection	
375210	Girder GT 24, l = 2.10 m	
amount	50	
load carrier	bundle	
packaging method	5 wide, 12 up	
packaging aid	steel strap, dunnage, edge protection	
375240	Girder GT 24, l = 2.40 m	
amount	50	
load carrier	bundle	
packaging method	5 wide, 12 up	
packaging aid	steel strap, dunnage, edge protection	
375270	Girder GT 24, l = 2.70 m	
amount	50	
load carrier	bundle	
packaging method	5 wide, 12 up	
packaging aid	steel strap, dunnage, edge protection	

Article No.	Article Name	Article Image
375300	Girder GT 24, l = 3.00 m	
amount	50	
load carrier	bundle	
packaging method	5 wide, 12 up	
packaging aid	steel strap, dunnage, edge protection	
375330	Girder GT 24, l = 3.30 m	
amount	50	
load carrier	bundle	
packaging method	5 wide, 12 up	
packaging aid	steel strap, dunnage, edge protection	
375360	Girder GT 24, l = 3.60 m	
amount	50	
load carrier	bundle	
packaging method	5 wide, 12 up	
packaging aid	steel strap, dunnage, edge protection	
375390	Girder GT 24, l = 3.90 m	
amount	50	
load carrier	bundle	
packaging method	5 wide, 12 up	
packaging aid	steel strap, dunnage, edge protection	
375420	Girder GT 24, l = 4.20 m	
amount	50	
load carrier	bundle	
packaging method	5 wide, 12 up	
packaging aid	steel strap, dunnage, edge protection	
375450	Girder GT 24, l = 4.50 m	
amount	50	
load carrier	bundle	
packaging method	5 wide, 12 up	
packaging aid	steel strap, dunnage, edge protection	
375480	Girder GT 24, l = 4.80 m	
amount	50	
load carrier	bundle	
packaging method	5 wide, 12 up	
packaging aid	steel strap, dunnage, edge protection	

Article No.	Article Name	Article Image
375510	Girder GT 24, L = 5.10 m	
amount	50	
load carrier	bundle	
packaging method	5 wide, 12 up	
packaging aid	steel strap, dunnage, edge protection	
375540	Girder GT 24, l = 5.40 m	
amount	50	
load carrier	bundle	
packaging method	5 wide, 12 up	
packaging aid	steel strap, dunnage, edge protection	
375570	Girder GT 24, l = 5.70 m	
amount	50	
load carrier	bundle	
packaging method	5 wide, 12 up	
packaging aid	steel strap, dunnage, edge protection	
375600	Girder GT 24, l = 6.00 m	
amount	50	
load carrier	bundle	
packaging method	5 wide, 12 up	
packaging aid	steel strap, dunnage, edge protection	

Article No.	Article Name	Article Image
373650	Girder VT 20K, Alpha I = 1.45 m	
amount	50	
load carrier	bundle	
packaging method	5 wide, 12 up	
packaging aid	steel strap, dunnage, edge protection	
373651	Girder VT 20K, Alpha I = 2.15 m	
amount	50	
load carrier	bundle	
packaging method	5 wide, 12 up	
packaging aid	steel strap, dunnage, edge protection,	
373652	Girder VT 20K, Alpha I = 2.45 m	
amount	50	
load carrier	bundle	
packaging method	5 wide, 12 up	
packaging aid	steel strap, dunnage, edge prot	
373653	Girder VT 20K, Alpha I = 2.65 m	
amount	50	
load carrier	bundle	
packaging method	5 wide, 12 up	
packaging aid	steel strap, dunnage, edge protecticn, 40 stacked straight, 80 stacked offset	
373654	Girder VT 20K, Alpha I = 2.90 m	
amount	50	
load carrier	bundle	
packaging method	5 wide, 12 up	
packaging aid	steel strap, dunnage, edge protection, 40 stacked straight, 80 stacked offset	
373655	Girder VT 20K, Alpha I = 3.30 m	
amount	50	
load carrier	bundle	
packaging method	5 wide, 12 up	
packaging aid	steel strap, dunnage, edge protection, 40 stacked straight, 80 stacked offset	
373656	Girder VT 20K, Alpha I = 3.60 m	
amount	50	
load carrier	bundle	
packaging method	5 wide, 12 up	
packaging aid	steel strap, dunnage, edge protection, 40 stacked straight, 80 stacked offset	

Article No.	Article Name	Article Image
373657	Girder VT 20K, Alpha I = 3.90 m	
amount	40 or 80	
load carrier	bundle	
packaging method	5 wide, 8 up or 5 wide, 16 up	
packaging aid	steel strap, dunnage, edge protection, 40 stacked straight, 80 stacked offset	
373658	Girder VT 20K, Alpha I = 4.50 m	
amount	40 or 80	
load carrier	bundle	
packaging method	5 wide, 8 up or 5 wide, 16 up	
packaging aid	steel strap, dunnage, edge protection, 40 stacked straight, 80 stacked offset	
373659	Girder VT 20K, Alpha I = 4.90 m	
amount	40 or 80	
load carrier	bundle	
packaging method	5 wide, 8 up or 5 wide, 16 up	
packaging aid	steel strap, dunnage, edge protection, 40 stacked straight, 80 stacked offset	
373660	Girder VT 20K, Alpha I = 5.90 m	
amount	40 or 80	
load carrier	bundle	
packaging method	5 wide, 8 up or 5 wide, 16 up	
packaging aid	steel strap, dunnage, edge protection, 40 stacked straight, 80 stacked offset	
373710	Girder VT 20 w/o cap, l= 1,45 m	
amount	40 or 80	
load carrier	bundle	
packaging method	5 wide, 8 up or 5 wide, 16 up	
packaging aid	steel strap, dunnage, edge protection, 40 stacked straight, 80 stacked offset	
373720	Girder VT 20 w/o cap, l= 2,15 m	
amount	40 or 80	
load carrier	bundle	
packaging method	5 wide, 8 up or 5 wide, 16 up	
packaging aid	steel strap, dunnage, edge protection, 40 stacked straight, 80 stacked offset	
373730	Girder VT 20 w/o cap, l= 2,45 m	
amount	40 or 80	
load carrier	bundle	
packaging method	5 wide, 8 up or 5 wide, 16 up	
packaging aid	steel strap, dunnage, edge protection, 40 stacked straight, 80 stacked offset	

Article No.	Article Name	Article Image
373740	Girder VT 20 w/o cap, l= 2,65 m	
amount	40 or 80	
load carrier	bundle	
packaging method	5 wide, 8 up or 5 wide, 16 up	
packaging aid	steel strap, dunnage, edge protection, 40 stacked straight, 80 stacked offset	
373750	Girder VT 20 w/o cap, l= 2,90 m	
amount	40 or 80	
load carrier	bundle	
packaging method	5 wide, 8 up or 5 wide, 16 up	
packaging aid	steel strap, dunnage, edge protection, 40 stacked straight, 80 stacked offset	
373760	Girder VT 20 w/o cap, l= 3,30 m	
amount	40 or 80	
load carrier	bundle	
packaging method	5 wide, 8 up or 5 wide, 16 up	
packaging aid	steel strap, dunnage, edge protection, 40 stacked straight, 80 stacked offset	
373770	Girder VT 20 w/o cap, l= 3,60 m	
amount	40 or 80	
load carrier	bundle	
packaging method	5 wide, 8 up or 5 wide, 16 up	
packaging aid	steel strap, dunnage, edge protection, 40 stacked straight, 80 stacked offset	
373780	Girder VT 20 w/o cap, l= 3,90 m	
amount	40 or 80	
load carrier	bundle	
packaging method	5 wide, 8 up or 5 wide, 16 up	
packaging aid	steel strap, dunnage, edge protection, 40 stacked straight, 80 stacked offset	
373790	Girder VT 20 w/o cap, l= 4,50 m	
amount	40 or 80	
load carrier	bundle	
packaging method	5 wide, 8 up or 5 wide, 16 up	
packaging aid	steel strap, dunnage, edge protection, 40 stacked straight, 80 stacked offset	
373800	Girder VT 20 w/o cap, l= 4,90 m	
amount	40 or 80	
load carrier	bundle	
packaging method	5 wide, 8 up or 5 wide, 16 up	
packaging aid	steel strap, dunnage, edge protection, 40 stacked straight, 80 stacked offset	

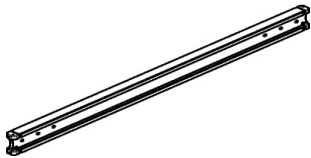
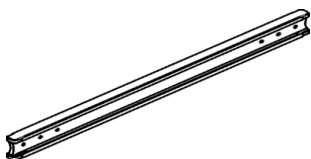
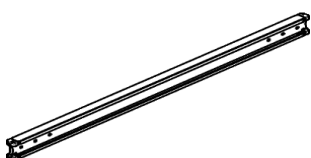
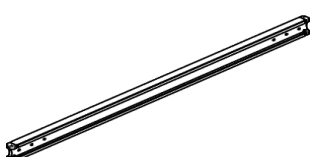
Article No.	Article Name	Article Image
373810	Girder VT 20 w/o cap, l= 5,90 m	
amount	40 or 80	
load carrier	bundle	
packaging method	5 wide, 8 up or 5 wide, 16 up	
packaging aid	steel strap, dunnage, edge protection, 40 stacked straight, 80 stacked offset	
374890	Girder VT 20K, l = 2.65 m	
amount	40 or 80	
load carrier	bundle	
packaging method	5 wide, 8 up or 5 wide, 16 up	
packaging aid	steel strap, dunnage, edge protection, 40 stacked straight, 80 stacked offset	
374905	Girder VT 20K, l = 2.15 m	
amount	40 or 80	
load carrier	bundle	
packaging method	5 wide, 8 up or 5 wide, 16 up	
packaging aid	steel strap, dunnage, edge protection, 40 stacked straight, 80 stacked offset	
374910	Girder VT 20K, l = 2.45 m	
amount	40 or 80	
load carrier	bundle	
packaging method	5 wide, 8 up or 5 wide, 16 up	
packaging aid	steel strap, dunnage, edge protection, 40 stacked straight, 80 stacked offset	
374920	Girder VT 20K, l = 2.90 m	
amount	40 or 80	
load carrier	bundle	
packaging method	5 wide, 8 up or 5 wide, 16 up	
packaging aid	steel strap, dunnage, edge protection, 40 stacked straight, 80 stacked offset	
374930	Girder VT 20K, l = 3.30 m	
amount	40 or 80	
load carrier	bundle	
packaging method	5 wide, 8 up or 5 wide, 16 up	
packaging aid	steel strap, dunnage, edge protection, 40 stacked straight, 80 stacked offset	
374940	Girder VT 20K, l = 3.60 m	
amount	40 or 80	
load carrier	bundle	
packaging method	5 wide, 8 up or 5 wide, 16 up	
packaging aid	steel strap, dunnage, edge protection, 40 stacked straight, 80 stacked offset	

Article No.	Article Name	Article Image
374950	Girder VT 20K, l = 3,90 m	
amount	40 or 80	
load carrier	bundle	
packaging method	5 wide, 8 up or 5 wide, 16 up	
packaging aid	steel strap, dunnage, edge protection, 40 stacked straight, 80 stacked offset	
374960	Girder VT 20K, l = 4.50 m	
amount	40 or 80	
load carrier	bundle	
packaging method	5 wide, 8 up or 5 wide, 16 up	
packaging aid	steel strap, dunnage, edge protection, 40 stacked straight, 80 stacked offset	
374970	Girder VT 20K, l = 4.90 m	
amount	40 or 80	
load carrier	bundle	
packaging method	5 wide, 8 up or 5 wide, 16 up	
packaging aid	steel strap, dunnage, edge protection, 40 stacked straight, 80 stacked offset	
374980	Girder VT 20K, l = 5.90 m	
amount	40 or 80	
load carrier	bundle	
packaging method	5 wide, 8 up or 5 wide, 16 up	
packaging aid	steel strap, dunnage, edge protection, 40 stacked straight, 80 stacked offset	
374990	Girder VT 20K, l = 1.45 m	
amount	40 or 80	
load carrier	bundle	
packaging method	5 wide, 8 up or 5 wide, 16 up	
packaging aid	steel strap, dunnage, edge protection, 40 stacked straight, 80 stacked offset	

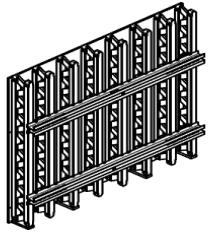
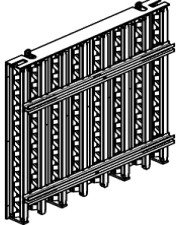
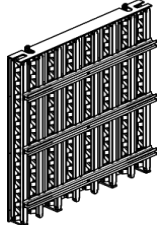
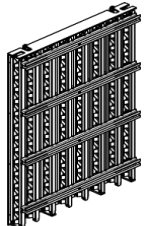
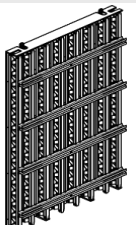
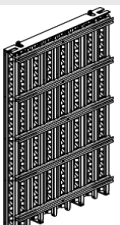
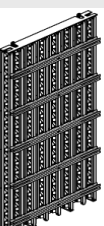
Article No.	Article Name	Article Image
401241	VARIO Standard Panel S 250 x 240	
amount	1	
load carrier	loose	
packaging method	stacked	
packaging aid		
401242	VARIO Standard Panel S 250 x 300	
amount	1	
load carrier	loose	
packaging method	stacked	
packaging aid		
401243	VARIO Standard Panel S 250 x 360	
amount	1	
load carrier	loose	
packaging method	stacked	
packaging aid		
401244	VARIO Standard Panel S 250 x 420	
amount	1	
load carrier	loose	
packaging method	stacked	
packaging aid		
401245	VARIO Standard Panel S 250 x 480	
amount	1	
load carrier	loose	
packaging method	stacked	
packaging aid		
401246	VARIO Standard Panel S 250 x 540	
amount	1	
load carrier	loose	
packaging method	stacked	
packaging aid		
401247	VARIO Standard Panel S 250 x 600	
amount	1	
load carrier	loose	
packaging method	stacked	
packaging aid		

Article No.	Article Name	Article Image
401248	VARIO Standard Panel S 187.5 x 240	
amount	1	
load carrier	loose	
packaging method	stacked	
packaging aid		
401249	VARIO Standard Panel S 187.5 x 300	
amount	1	
load carrier	loose	
packaging method	stacked	
packaging aid		
401250	VARIO Standard Panel S 187.5 x 360	
amount	1	
load carrier	loose	
packaging method	stacked	
packaging aid		
401251	VARIO Standard Panel S 187.5 x 420	
amount	1	
load carrier	loose	
packaging method	stacked	
packaging aid		
401252	VARIO Standard Panel S 187.5 x 480	
amount	1	
load carrier	loose	
packaging method	stacked	
packaging aid		
401253	VARIO Standard Panel S 187.5 x 540	
amount	1	
load carrier	loose	
packaging method	stacked	
packaging aid		
401254	VARIO Standard Panel S 187.5 x 600	
amount	1	
load carrier	loose	
packaging method	stacked	
packaging aid		

Article No.	Article Name	Article Image
401255	VARIO Standard Panel S 125 x 240	
amount	1	
load carrier	loose	
packaging method	stacked	
packaging aid		
401256	VARIO Standard Panel S 125 x 300	
amount	1	
load carrier	loose	
packaging method	stacked	
packaging aid		
401257	VARIO Standard Panel S 125 x 360	
amount	1	
load carrier	loose	
packaging method	stacked	
packaging aid		
401258	VARIO Standard Panel S 125 x 420	
amount	1	
load carrier	loose	
packaging method	stacked	
packaging aid		
401259	VARIO Standard Panel S 125 x 480	
amount	1	
load carrier	loose	
packaging method	stacked	
packaging aid		
401260	VARIO Standard Panel S 125 x 540	
amount	1	
load carrier	loose	
packaging method	stacked	
packaging aid		
401261	VARIO Standard Panel S 125 x 600	
amount	1	
load carrier	loose	
packaging method	stacked	
packaging aid		

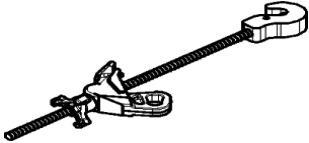
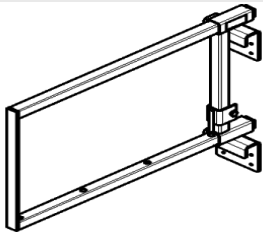
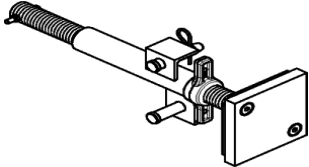
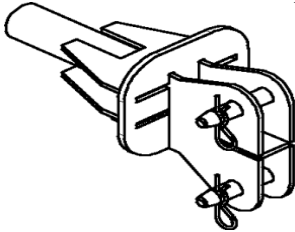
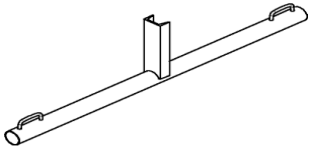
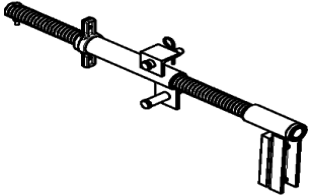
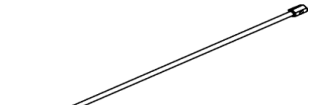

Article No.	Article Name	Article Image
401405	VARIO Standard Panel S 100 x 600	
amount	1	
load carrier	loose	
packaging method	stacked	
packaging aid		
401407	VARIO Standard Panel S 100 x 480	
amount	1	
load carrier	loose	
packaging method	stacked	
packaging aid		
401409	VARIO Standard Panel S 100 x 360	
amount	1	
load carrier	loose	
packaging method	stacked	
packaging aid		
401410	VARIO Standard Panel S 100 x 300	
amount	1	
load carrier	loose	
packaging method	stacked	
packaging aid		
401411	VARIO Standard Panel S 100 x 240	
amount	1	
load carrier	loose	
packaging method	stacked	
packaging aid		
401465	VARIO Internal Edge S 75/75 x 600	
amount	2	
load carrier	bundle	
packaging method	stacked	
packaging aid	steel strap	
401467	VARIO Internal Edge S 75/75 x 480	
amount	2	
load carrier	bundle	
packaging method	stacked	
packaging aid	steel strap	

Article No.	Article Name	Article Image
401469	VARIO Internal Edge S 75/75 x 360	
amount	2	
load carrier	bundle	
packaging method	stacked	
packaging aid	steel strap	
401470	VARIO Internal Edge S 75/75 x 300	
amount	2	
load carrier	bundle	
packaging method	stacked	
packaging aid	steel strap	
401471	VARIO Internal Edge S 75/75 x 240	
amount	2	
load carrier	bundle	
packaging method	stacked	
packaging aid	steel strap	
403942	Tie Plate FTF DW 15	
amount	150	
load carrier	hardware box	
packaging method	loose	
packaging aid	steel strap, wooden cover plate	
403944	Waler Connector FTF/SRU/RS	
amount	80	
load carrier	wire crate k	
packaging method	loose	
packaging aid	steel strap, wooden cover plate	
403945	Scaffold Tube Connector FTF	
amount	350	
load carrier	wire crate k	
packaging method	loose	
packaging aid	steel strap, wooden cover plate	
403981	Bracket FTF 500	
amount	3	
load carrier	post pallet RP 150	
packaging method	loose	
packaging aid	upright	

Article No.	Article Name	Article Image
404017	Tie Unit FTF 65/DW 15	
amount	100	
load carrier	wire crate k	
packaging method	loose	
packaging aid	steel strap, wooden cover plate	
404018	End Guardrail FTF, adjustable	
amount	16	
load carrier	wire crate k	
packaging method	stacked	
packaging aid	steel strap	
404070	Spindle Guide FTF	
amount	100	
load carrier	wire crate k	
packaging method	loose	
packaging aid	steel strap, wooden cover plate	
404083	Waler Connector FTF/SRU	
amount	80	
load carrier	wire crate k	
packaging method	loose	
packaging aid	steel strap, wooden cover plate	
404195	Assembly Aid FTF	
amount	20	
load carrier	post pallet RP 120	
packaging method	stacked	
packaging aid	steel strap	
404744	Fixation Clamp FTF	
amount	100	
load carrier	wire crate k	
packaging method	loose	
packaging aid	steel strap, wooden cover plate	
404803	Wrench FTF SW 38/1500	
amount	1	
load carrier	loose	
packaging method	loose	
packaging aid		

Article No.	Article Name	Article Image
405822	Bolt Ø 20 x 102, galv.	
amount	2000	
load carrier	hardware box	
packaging method	40 bags, 50 per bag	
packaging aid	steel strap, wooden cover plate	
408543	Coupler BPA D=125	
amount	100	
load carrier	hardware box	
packaging method	loose	
packaging aid	steel strap, wooden cover plate	
415009	Concrete Pump Connector BPA-2, 125	
amount	20	
load carrier	wire crate k	
packaging method	stacked	
packaging aid	steel strap, wooden cover plate	
415010	Vacating Device BPA-2 D=125	
amount	20	
load carrier	hardware box	
packaging method	loose	
packaging aid	steel strap, wooden cover plate	

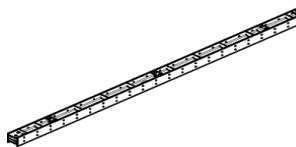
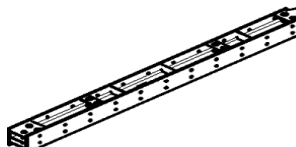
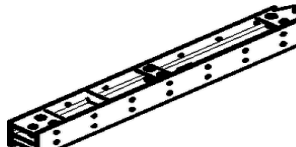
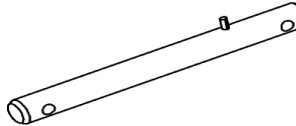
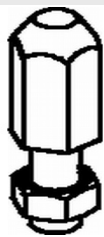
Article No.	Article Name	Article Image
322001	Waler Hinge, galv.	
amount	60	
load carrier	wire crate k	
packaging method	stacked	
packaging aid		
322002	Waler Hinge Adjustable, galv.	
amount	48	
load carrier	wire crate k	
packaging method	stacked	
packaging aid	steel strap, wooden cover plate	
322003	Lowering Device HDA	
amount	20	
load carrier	wire crate k	
packaging method	2 layers, 12 on bottom, 8 on top, drilled out	
packaging aid	steel strap, wooden plate between each layer, wooden cover plate	
322004	Prop Section HDS 270 Alu	
amount	8	
load carrier	post pallet RP 150	
packaging method	stacked	
packaging aid	steel strap	
322005	Prop Section HDS 90 Alu	
amount	13	
load carrier	wire crate k	
packaging method	stacked	
packaging aid	steel strap, wooden cover plate	
322006	Prop Section HDS 30 Alu	
amount	40	
load carrier	wire crate k	
packaging method	stacked	
packaging aid	steel strap, wooden cover plate	
322007	Head Spindle HDK 45	
amount	12	
load carrier	wire crate k	
packaging method	upright	
packaging aid	steel strap, wooden cover plate	

Article No.	Article Name	Article Image
322008	Main Beam HDT 880	
amount	2	
load carrier	bundle	
packaging method	side by side	
packaging aid	steel strap, dunnage	
322009	Main Beam HDT 440	
amount	4	
load carrier	bundle	
packaging method	side by side	
packaging aid	steel strap, dunnage	
322010	Main Beam HDT 280	
amount	4	
load carrier	bundle	
packaging method	side by side	
packaging aid	steel strap, dunnage	
322011	Double Anchor Tie Yoke HDD	
amount	100	
load carrier	hardware box	
packaging method	stacked	
packaging aid	steel strap, wooden cover plate	
322013	Centring Bolt HD M12, galv.	
amount	500	
load carrier	hardware box	
packaging method	50 per bag	
packaging aid	steel strap, wooden cover plate	
322014	Main Beam Clamp HD 40mm, galv.	
amount	500	
load carrier	hardware box	
packaging method	loose	
packaging aid	steel strap, wooden cover plate	
322016	Brace Connector HDR	
amount	250	
load carrier	hardware box	
packaging method	loose	
packaging aid	steel strap, wooden cover plate	

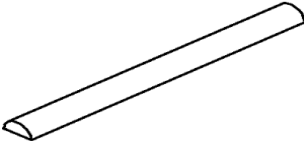
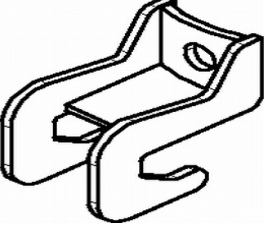
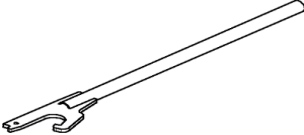
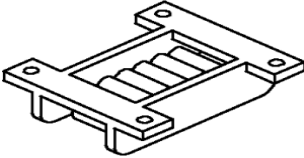
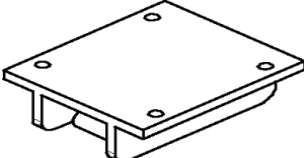
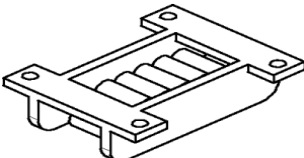
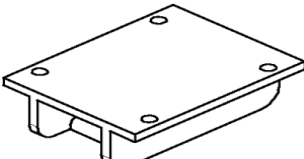

Article No.	Article Name	Article Image
322017	Scaffold Bracket HD 75	
amount	35	
load carrier	wire crate k	
packaging method	stacked	
packaging aid	steel strap, wooden cover plate	
322019	Base Adapter HD	
amount	72	
load carrier	wire crate k	
packaging method	2 layers, 36 per layer	
packaging aid	steel strap, wooden cover plate, wooden plate between each layer	
322020	Coupling Section HD 30	
amount	40	
load carrier	wire crate k	
packaging method	stacked	
packaging aid	steel strap, wooden cover plate	
322021	Trolley HD	
amount	4	
load carrier	wire crate k	
packaging method	stacked	
packaging aid	steel strap, wooden cover plate	
322022	Compression Head HD	
amount	20	
load carrier	wire crate k	
packaging method	2 layers, 10 per layer	
packaging aid	steel strap, wooden cover plate	
322023	Compression Brace Spindle HD	
amount	12	
load carrier	wire crate k	
packaging method	stacked	
packaging aid	upright	
322024	Base Plate HD	
amount	48	
load carrier	wire crate k	
packaging method	stacked	
packaging aid	steel strap, wooden cover plate	



Article No.	Article Name	Article Image
322025	Centering Bar 40 x 20 x 400	
amount	250	
load carrier	hardware box	
packaging method	loose	
packaging aid	steel strap, wooden cover plate	
322026	Steel Beam Clamp IPB 300 - 1000	
amount	250	
load carrier	hardware box	
packaging method	loose	
packaging aid	steel strap, wooden cover plate	
322027	Wing Nut Spanner HD	
amount	1	
load carrier	loose	
packaging method	loose	
packaging aid		
322040	Heavy Duty Roller 150 kN, Type B-II	
amount	50	
load carrier	hardware box	
packaging method	stacked	
packaging aid	steel strap, wooden cover plate	
322041	Heavy Duty Roller 200 kN, Type A-II	
amount	50	
load carrier	hardware box	
packaging method	stacked	
packaging aid	steel strap, wooden cover plate	
322042	Heavy Duty Roller 300 kN, Type B-III	
amount	50	
load carrier	hardware box	
packaging method	stacked	
packaging aid	steel strap, wooden cover plate	
322044	Heavy Duty Roller 400 kN, Type A-III	
amount	50	
load carrier	hardware box	
packaging method	stacked	
packaging aid	steel strap, wooden cover plate	



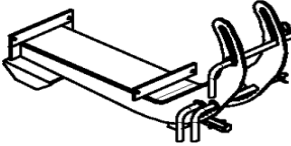
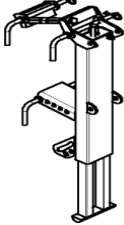
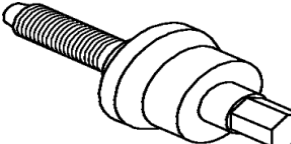

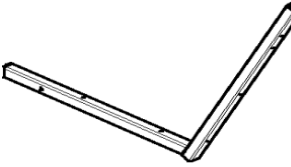
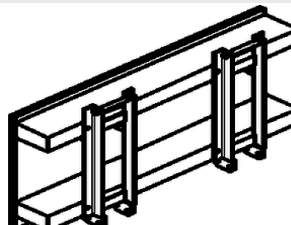
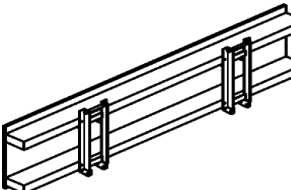
Article No.	Article Name	Article Image
356032	GKW Ballast 2,25 t	
amount	1	
load carrier	loose	
packaging method	stacked	
packaging aid		
401773	Heavy Duty Spindle SLS 80/140	
amount	40	
load carrier	wire crate k	
packaging method	8 wide, 5 up	
packaging aid	steel strap, square timber	
401774	Heavy Duty Spindle SLS 100/180	
amount	40	
load carrier	post pallet RP 120	
packaging method	8 wide, 5 up	
packaging aid	steel strap, square timber	
401776	Heavy Duty Spindle SLS 140/240	
amount	28	
load carrier	post pallet RP 120	
packaging method	7 wide, 4 up	
packaging aid	steel strap	
401778	Heavy Duty Spindle SLS 200/300	
amount	28	
load carrier	post pallet RP 150	
packaging method	7 wide, 4 up	
packaging aid	steel strap, square timber	
401779	Heavy Duty Spindle SLS 260/360	
amount	28	
load carrier	post pallet RP 150	
packaging method	7 wide, 4 up	
packaging aid	steel strap, square timber	
401916	Height Compensation 200, l = 295	
amount	42	
load carrier	wire crate k	
packaging method	stacked	
packaging aid	steel strap, wooden cover plate	

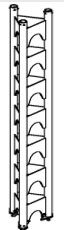
Article No.	Article Name	Article Image
402184	GKB Cantilever Parapet Platform 180 x 240	
amount	5	
load carrier	bundle	
packaging method	stacked	
packaging aid	steel strap, dunnage	
402185	GKB Cantilever Parapet Platform 180 x 120	
amount	5	
load carrier	bundle	
packaging method	stacked	
packaging aid	steel strap, dunnage	
402186	GKB Protection Board 240	
amount	6	
load carrier	bundle	
packaging method	stacked	
packaging aid	steel strap, dunnage	
402187	GKB Protection Board 120	
amount	6	
load carrier	bundle	
packaging method	stacked	
packaging aid	steel strap, dunnage	
402188	GKB Protection Board 90/120	
amount	10	
load carrier	bundle	
packaging method	stacked	
packaging aid	steel strap, dunnage	
402190	GKB Soffit Formwork 45 x 245	
amount	6	
load carrier	bundle	
packaging method	stacked	
packaging aid	steel strap, dunnage	
402193	GKB Soffit Formwork 45 x 120	
amount	6	
load carrier	bundle	
packaging method	stacked	
packaging aid	steel strap, dunnage	

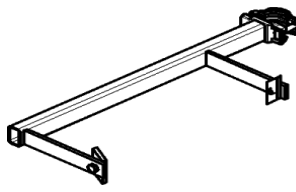
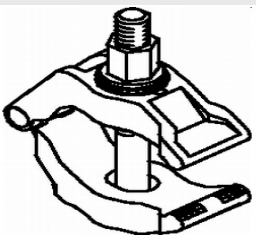
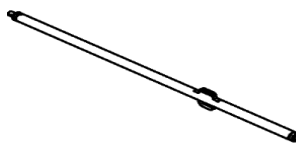
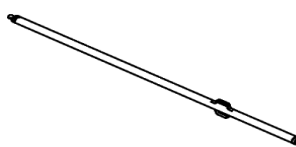
Article No.	Article Name	Article Image
402195	GKB Board Formwork 140 x 120	
amount	6	
load carrier	bundle	
packaging method	stacked	
packaging aid	steel strap, dunnage	
402196	GKB Spindle for Cantilever Slab Formwork	
amount	30	
load carrier	wire crate k	
packaging method	stacked	
packaging aid	steel strap, wooden cover plate	
402197	GKB Work Cage	
amount	1	
load carrier	loose	
packaging method	bundeled with 2 timbers	
packaging aid		
402217	GKB Abutment Bracket 180	
amount	16	
load carrier	post pallet RP 150	
packaging method	stacked	
packaging aid	steel strap	
402219	GKB Abutment Platform 180 x 240	
amount	4	
load carrier	bundle	
packaging method	stacked	
packaging aid	steel strap, dunnage	
402220	GKB Abutment Platform 180 x 120	
amount	4	
load carrier	bundle	
packaging method	stacked	
packaging aid	steel strap, dunnage	
402327	GKB Cantilever Parapet Bracket 180	
amount	3	
load carrier	post pallet RP 150	
packaging method	stacked	
packaging aid	steel strap	

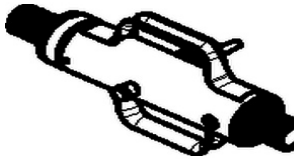
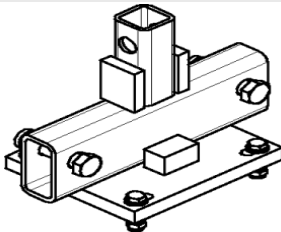
Article No.	Article Name	Article Image
402328	GKB Soffit Formwork Beam	
amount	16	
load carrier	wire crate k	
packaging method	stacked	
packaging aid	steel strap, wooden cover plate	
402329	GKB Side Formwork Beam	
amount	16	
load carrier	bundle	
packaging method	stacked	
packaging aid	steel strap, dunnage	
402394	GKB Anchor Bolt M 24 x 200/10°	
amount	100	
load carrier	hardware box	
packaging method	loose	
packaging aid	steel strap, wooden cover plate	
402395	GKB Handrail Post	
amount	30	
load carrier	post pallet RP 150	
packaging method	stacked	
packaging aid	steel strap	
402396	GKB Handrail Post 115°	
amount	40	
load carrier	post pallet RP 150	
packaging method	stacked	
packaging aid	steel strap	
402778	GKB Side Formwork 60 x 120	
amount	6	
load carrier	bundle	
packaging method	stacked	
packaging aid	steel strap, dunnage	
402779	GKB Side Formwork 60 x 245	
amount	6	
load carrier	bundle	
packaging method	stacked	
packaging aid	steel strap, dunnage	

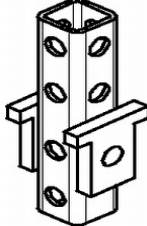
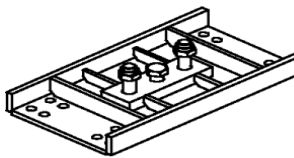
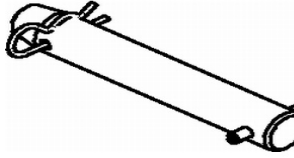
Article No.	Article Name	Article Image
402822	GKB Side Formwork Bracket	
amount	60	
load carrier	wire crate k	
packaging method	stacked	
packaging aid	steel strap, wooden cover plate	
403993	Prop Section HDSS 210 Steel	
amount	8	
load carrier	post pallet RP 150	
packaging method	stacked	
packaging aid	steel strap	
404181	GKB Work cage protection panel	
amount	1	
load carrier	loose	
packaging method	bundeled with 2 timbers	
packaging aid		
404646	Ladder Connector HD 200	
amount	30	
load carrier	hardware box	
packaging method	loose	
packaging aid	steel strap, wooden cover plate	
406183	Main Beam Clamp HD 70 mm, galv.	
amount	400	
load carrier	hardware box	
packaging method	loose	
packaging aid	steel strap, wooden cover plate	
409726	Heavy Duty Spindle SLS 320/420	
amount	28	
load carrier	post pallet RP 150	
packaging method	7 wide, 4 up	
packaging aid	steel strap, square timber	
409785	Heavy Duty Spindle SLS 380/480	
amount	28	
load carrier	post pallet RP 150	
packaging method	7 wide, 4 up	
packaging aid	steel strap, square timber	

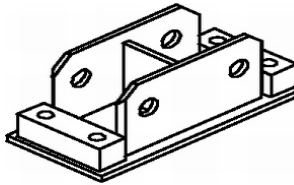
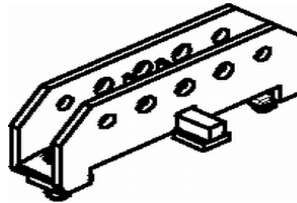
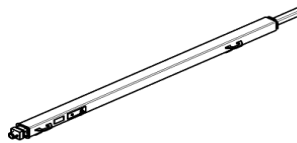
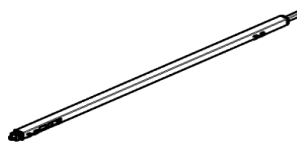
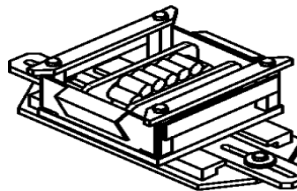
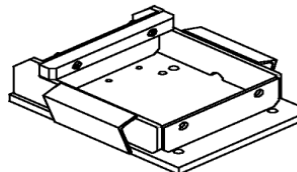

Article No.	Article Name	Article Image
411035	Heavy Duty Spindle SLS 40/80	
amount	80	
load carrier	wire crate k	
packaging method	loose	
packaging aid	steel strap, wooden cover plate	
411274	Heavy Duty Roller Bracket VARIOKIT	
amount	40	
load carrier	wire crate k	
packaging method	loose	
packaging aid	steel strap, wooden cover plate	
411276	Prop Section HDSS 90 Steel	
amount	13	
load carrier	wire crate k	
packaging method	stacked	
packaging aid	steel strap, wooden cover plate	
411279	Cross Connector VARIOKIT	
amount	162	
load carrier	hardware box	
packaging method	3 rows, 18 per row, 3 up	
packaging aid	steel strap, wooden plate between each layer, wooden cover plate	
412488	Cable Winch Adapter VARIOKIT	
amount	40	
load carrier	hardware box	
packaging method	loose	
packaging aid	steel strap, wooden cover plate	
412547	Pin Hd Dia 40 x 260	
amount	300	
load carrier	hardware box	
packaging method	loose	
packaging aid	steel strap, wooden cover plate	
412548	Truss Strut HD 2000	
amount	15	
load carrier	post pallet RP 150	
packaging method	5 wide, 3 up	
packaging aid	steel strap	

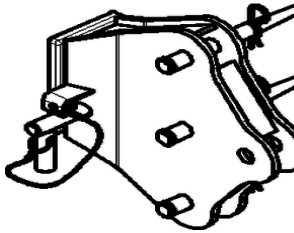
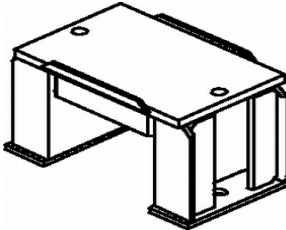
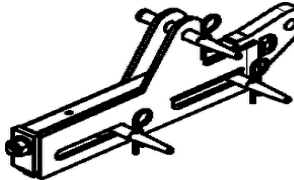
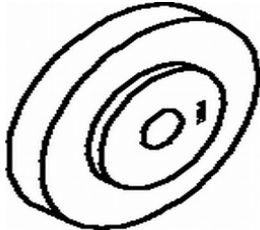
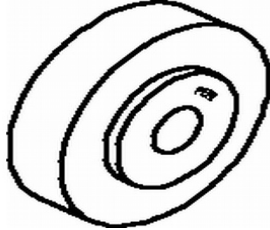
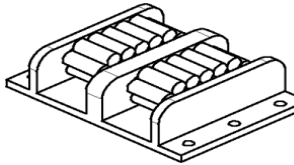
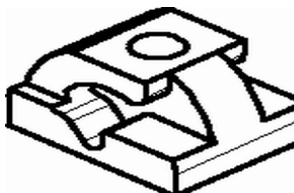
Article No.	Article Name	Article Image
412549	Truss Strut HD 2247	
amount	15	
load carrier	post pallet RP 150	
packaging method	5 wide, 3 up / crosswise stacked	
packaging aid	steel strap, wooden strip between each layer	
412558	Truss Bracket HD	
amount	28	
load carrier	wire crate k	
packaging method	stacked	
packaging aid	steel strap, wooden cover plate	
412816	Spindle Spreader Vario Kit	
amount	80	
load carrier	wire crate k	
packaging method	stacked	
packaging aid	steel strap, wooden cover plate	
412840	Strut VARIOKIT I = 400-700	
amount	5	
load carrier	bundle	
packaging method	5 wide, 1 up	
packaging aid	3 x steel strap, 3 x square timber	
412841	Strut VARIOKIT I = 600-900	
amount	5	
load carrier	bundle	
packaging method	5 wide, 1 up	
packaging aid	3 x steel strap, 3 x square timber	
413474	Heavy Duty Roller 650 kN, steerable	
amount	4	
load carrier	wire crate k	
packaging method	stacked	
packaging aid	steel strap, wooden cover plate	
413475	Heavy Duty Roller Support Fix	
amount	20	
load carrier	wire crate k	
packaging method	stacked	
packaging aid	steel strap, wooden cover plate	

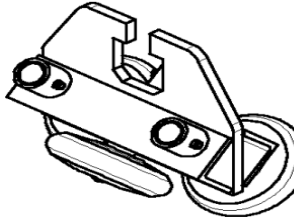
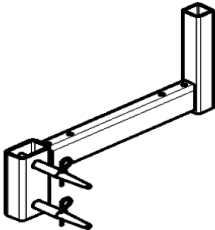
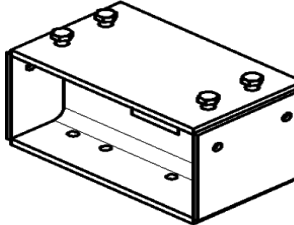
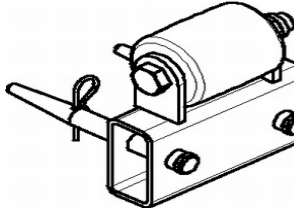
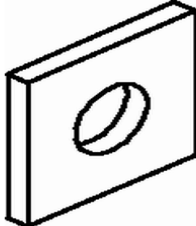
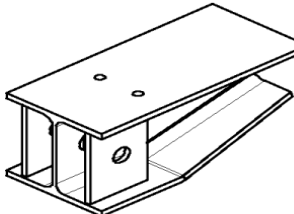
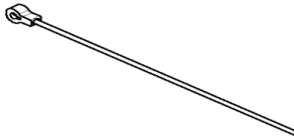
Article No.	Article Name	Article Image
413643	Mounting Ring Adapter SRU	
amount	30	
load carrier	wire crate k	
packaging method	stacked	
packaging aid	steel strap, wooden cover plate	
413770	Support Brace 250 Rail	
amount	27	
load carrier	wire crate k	
packaging method	3 layers, 9 per layer	
packaging aid	steel strap, wooden plate between each layer, wooden cover plate	
413933	Adjusting Unit VARIOKIT	
amount	50	
load carrier	wire crate k	
packaging method	stacked	
packaging aid	steel strap, wooden cover plate	
414082	Counterplate RCS DW 20	
amount	200	
load carrier	hardware box	
packaging method	loose	
packaging aid	steel strap, wooden cover plate	
414084	Counterplate RCS DW 26	
amount	200	
load carrier	hardware box	
packaging method	loose	
packaging aid	steel strap, wooden cover plate	
414335	Heavy Duty Roller 340 kN, Type H-II	
amount	50	
load carrier	hardware box	
packaging method	stacked	
packaging aid	steel strap, wooden cover plate	
414534	Suspension Anchor M24 VARIOKIT	
amount	460	
load carrier	hardware box	
packaging method	loose	
packaging aid	steel strap, wooden cover plate	

Article No.	Article Name	Article Image
414535	Roller Unit VARIOKIT	
amount	80	
load carrier	wire crate k	
packaging method	4 layers, 20 per layer	
packaging aid	steel strap, wooden plate between each layer, wooden cover plate	
414557	Platform Beam SRU	
amount	70	
load carrier	wire crate k	
packaging method	stacked	
packaging aid	steel strap, wooden cover plate	
414572	Connector Drive Unit 300 VK	
amount	6	
load carrier	wire crate k	
packaging method	stacked	
packaging aid	steel strap, square timber	
414599	Pressure Roller VARIOKIT	
amount	140	
load carrier	wire crate k	
packaging method	stacked	
packaging aid	steel strap, wooden cover plate	
414618	Spindle Counter Plate VARIOKIT	
amount	600	
load carrier	hardware box	
packaging method	loose	
packaging aid	steel strap, wooden cover plate	
415074	Rail Slide HDT	
amount	8	
load carrier	wire crate k	
packaging method	2 layers, 4 per layer	
packaging aid	steel strap, wooden cover plate	
415538	Tie Rod with Yoke VARIOKIT	
amount	100	
load carrier	hardware box	
packaging method	loose	
packaging aid	steel strap, wooden cover plate	

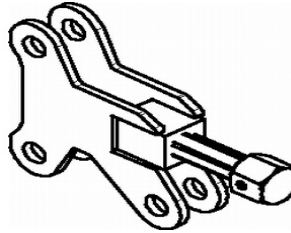
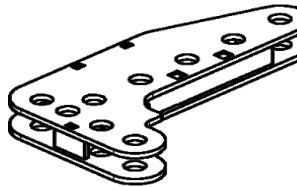
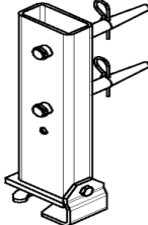
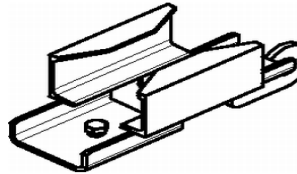
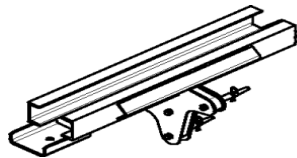
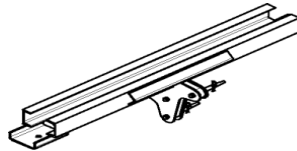
Article No.	Article Name	Article Image
415549	Control cabinet Drive Unit VARIOKIT	
amount	2	
load carrier	hardware box	
packaging method	stacked	
packaging aid	steel strap, wooden cover plate	
415550	Operating Switch Drive Unit VARIOKIT	
amount	10	
load carrier	hardware box	
packaging method	stacked	
packaging aid	steel strap, wooden cover plate	
415551	Cable Connection VARIOKIT 3 m	
amount	20	
load carrier	hardware box	
packaging method	loose	
packaging aid	steel strap, wooden cover plate	
415552	Cable Connection VARIOKIT 25 m	
amount	10	
load carrier	hardware box	
packaging method	loose	
packaging aid	steel strap, wooden cover plate	
415553	Drive Unit VARIOKIT	
amount	2	
load carrier	wire crate k	
packaging method	stacked	
packaging aid	steel strap, wooden cover plate	
415554	Wheel Block VARIOKIT	
amount	12	
load carrier	wire crate k	
packaging method	stacked	
packaging aid	steel strap, wooden cover plate	
415599	Strut Connector-2 VARIOKIT	
amount	10	
load carrier	wire crate k	
packaging method	stacked	
packaging aid	steel strap, wooden cover plate	



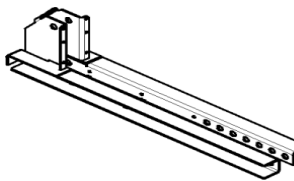
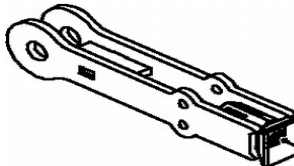
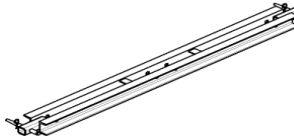
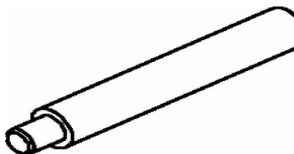
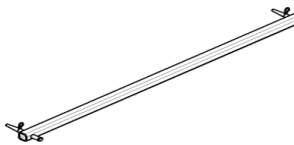
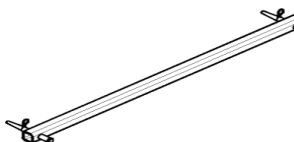

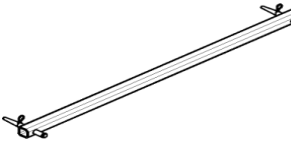
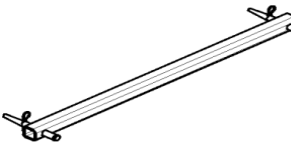
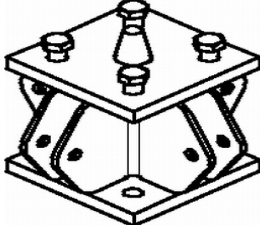
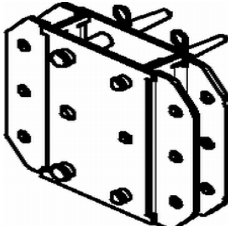
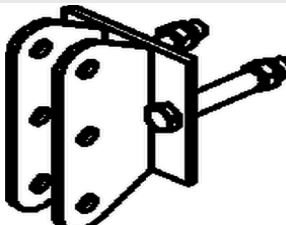
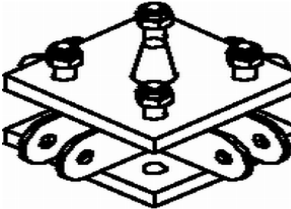
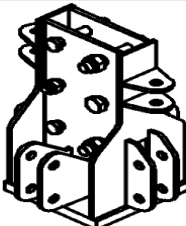
Article No.	Article Name	Article Image
415616	Waler Jack with Connector VARIOKIT	
amount	150	
load carrier	hardware box	
packaging method	loose	
packaging aid	steel strap, wooden cover plate	
415623	Connector SRU VARIOKIT	
amount	100	
load carrier	hardware box	
packaging method	20 wide, 5 up	
packaging aid	steel strap, wooden cover plate	
415682	Height Adjustment VARIOKIT	
amount	96	
load carrier	wire crate k	
packaging method	6 layers, 16 per layer	
packaging aid	steel strap, wooden plate between each layer, wooden cover plate	
416111	Rail Slide 25 VARIOKIT	
amount	32	
load carrier	wire crate k	
packaging method	4 layers, 22 per layer	
packaging aid	steel strap, wooden cover plate	
416291	Guide Rail 100 VARIOKIT	
amount	5	
load carrier	wire crate k	
packaging method	stacked	
packaging aid	steel strap, wooden cover plate	
416297	Guide Rail 150 VARIOKIT	
amount	7	
load carrier	post pallet RP 150	
packaging method	2 layers, 4 on bottom, 3 on top	
packaging aid	steel strap	
416363	Spacer RCS 184	
amount	1500	
load carrier	hardware box	
packaging method	loose	
packaging aid	steel strap, wooden cover plate	

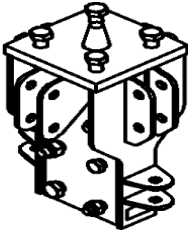
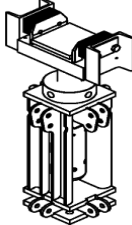
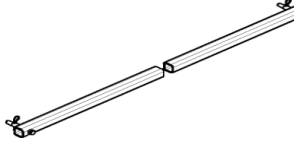
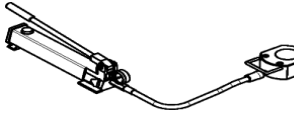
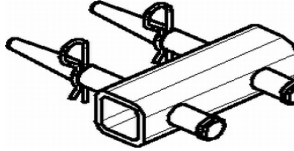
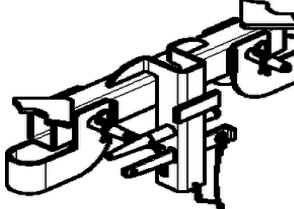
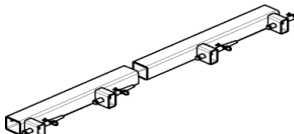
Article No.	Article Name	Article Image
416446	Formwork Girder VGB 90	
amount	20	
load carrier	wire crate k	
packaging method	4 wide, 5 up	
packaging aid	steel strap, wooden cover plate	
416532	Tie Yoke VARIOKIT Ø 22 / DW 15	
amount	200	
load carrier	hardware box	
packaging method	stacked	
packaging aid	steel strap, wooden cover plate	
417027	Holder Platform Drive Unit	
amount	80	
load carrier	wire crate k	
packaging method	stacked	
packaging aid	steel strap, wooden cover plate	
417371	Horizontal Ledger VST 200	
amount	28	
load carrier	post pallet RP 120	
packaging method	8 wide, 3 up + 4	
packaging aid	steel strap	
417377	Assembly Handhold VST	
amount	250	
load carrier	hardware box	
packaging method	loose	
packaging aid	steel strap, wooden cover plate	
417379	Diagonal Strut VST 200/150	
amount	65	
load carrier	post pallet RP 120	
packaging method	13 wide, 5 up	
packaging aid	steel strap	
417382	Diagonal Strut VST 200/100	
amount	65	
load carrier	post pallet RP 120	
packaging method	13 wide, 5 up	
packaging aid	steel strap	

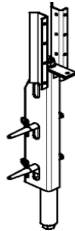
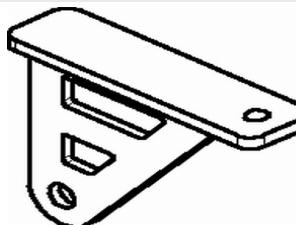
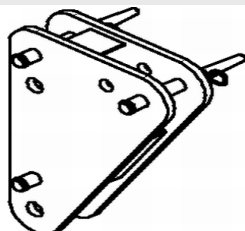
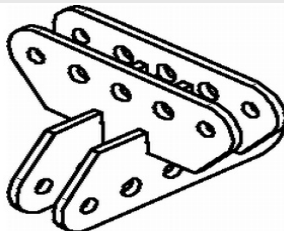
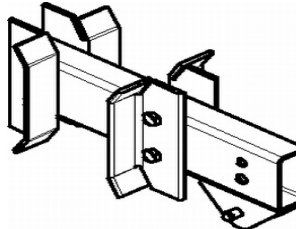
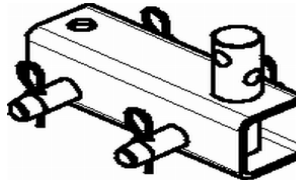
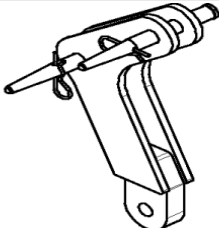

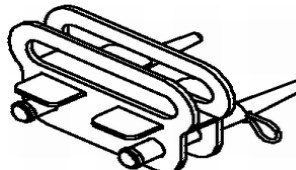
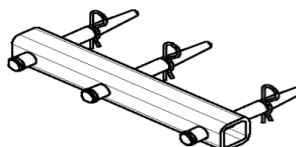
Article No.	Article Name	Article Image
417385	Diagonal Strut VST 200/112.5	
amount	65	
load carrier	post pallet RP 120	
packaging method	13 wide, 5 up	
packaging aid	steel strap	
417388	Diagonal Strut VST 200/62.5	
amount	75	
load carrier	wire crate k	
packaging method	15 wide, 5 up	
packaging aid	steel strap, wooden cover plate	
417391	Height Adjust VST 25	
amount	16	
load carrier	wire crate k	
packaging method	stacked	
packaging aid	steel strap, wooden cover plate	
417411	Bracing Connector VST	
amount	32	
load carrier	wire crate k	
packaging method	16 wide, 2 up	
packaging aid	steel strap, wooden cover plate	
417425	Cross Connector VST	
amount	108	
load carrier	wire crate k	
packaging method	4 layers, 27 per layer	
packaging aid	steel strap, wooden cover plate	
417433	Height Adjust VST 12.5	
amount	30	
load carrier	wire crate k	
packaging method	stacked	
packaging aid	steel strap, wooden cover plate	
417453	Prop Base VST 48	
amount	10	
load carrier	wire crate k	
packaging method	loose	
packaging aid	steel strap, wooden cover plate	

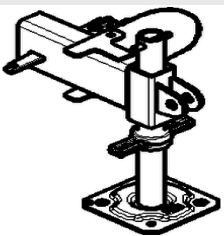
Article No.	Article Name	Article Image
417454	Prop Connector VST 48	
amount	10	
load carrier	wire crate k	
packaging method	stacked	
packaging aid	steel strap, wooden cover plate	
417465	Head Spindle VST 100	
amount	4	
load carrier	wire crate k	
packaging method	loose	
packaging aid	steel strap, wooden cover plate	
417504	Horizontal Brace VST200/200	
amount	65	
load carrier	post pallet RP 150	
packaging method	5 layers, 13 per layer	
packaging aid	steel strap, square timber between each layer	
417678	Hydraulic Unit VST	
amount	12	
load carrier	wire crate k	
packaging method	stacked	
packaging aid	steel strap, wooden cover plate	
417696	Horizontal Connector VST	
amount	150	
load carrier	wire crate k	
packaging method	loose	
packaging aid	steel strap, wooden cover plate	
417707	Connector UP-VST	
amount	40	
load carrier	wire crate k	
packaging method	loose	
packaging aid	steel strap, wooden cover plate	
417712	Leg-Connector VST	
amount	32	
load carrier	post pallet RP 150	
packaging method	8 wide, 4 up	
packaging aid	steel strap	

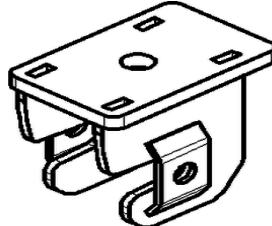
Article No.	Article Name	Article Image
418274	Vertical Post VGB, adjustable	
amount	30	
load carrier	wire crate k	
packaging method	5 wide, 6 up	
packaging aid	steel strap, wooden cover plate	
418572	Tension Support VGB 4 t	
amount	50	
load carrier	wire crate k	
packaging method	stacked	
packaging aid	steel strap, wooden cover plate	
423497	Spindle Bracket VARIOKIT	
amount	40	
load carrier	wire crate k	
packaging method	2 wide, 20 up	
packaging aid	steel strap, wooden cover plate	
423509	Cross Connector RCS	
amount	45	
load carrier	wire crate k	
packaging method	stacked	
packaging aid	steel strap, wooden cover plate	
423513	Slide Connector VARIOKIT	
amount	12	
load carrier	wire crate k	
packaging method	2 layers, 6 per layer	
packaging aid	steel strap, wooden cover plate	
423534	Brace Connector RCS DW 15/M20	
amount	150	
load carrier	wire crate k	
packaging method	loose	
packaging aid	steel strap, wooden cover plate	
423727	Adapter VGB	
amount	100	
load carrier	wire crate k	
packaging method	loose	
packaging aid	steel strap, wooden cover plate	

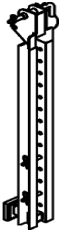
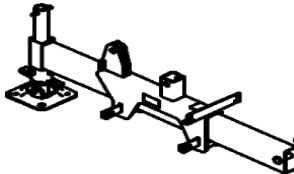
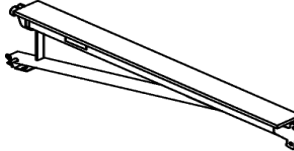
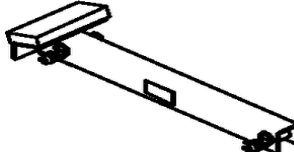
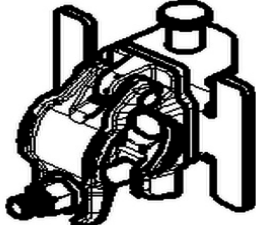
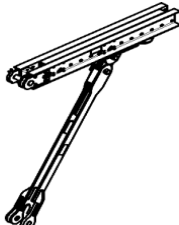
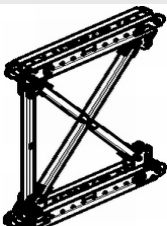
Article No.	Article Name	Article Image
423732	UP Lift Protector SRU	
amount	180	
load carrier	wire crate k	
packaging method	5 layers, 6 x 6 per layer	
packaging aid	steel strap, wooden cover plate	
423823	Adapter VST- SRU	
amount	150	
load carrier	wire crate k	
packaging method	loose	
packaging aid	steel strap, wooden cover plate	
424360	Formwork Post Extension VGK 40	
amount	150	
load carrier	wire crate k	
packaging method	loose	
packaging aid	steel strap, wooden cover plate	
424371	Formwork Post VGK 70	
amount	80	
load carrier	wire crate k	
packaging method	16 wide, 5 up	
packaging aid	steel strap, wooden plate between each layer, wooden cover plate	
424394	Formwork Fixing VGK 2	
amount	100	
load carrier	wire crate k	
packaging method	loose	
packaging aid	steel strap, wooden cover plate	
424404	Bracket Post VGK 110	
amount	25	
load carrier	wire crate k	
packaging method	5 wide, 5 up	
packaging aid	steel strap, wooden cover plate	
424413	Suspension Head VGK	
amount	256	
load carrier	wire crate k	
packaging method	64 wide, 4 up	
packaging aid	steel strap, wooden cover plate	

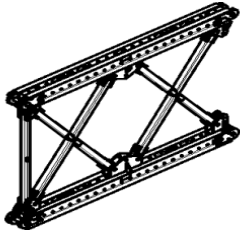
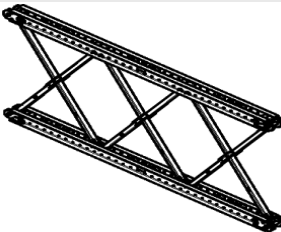
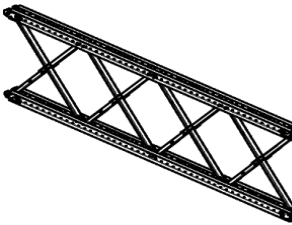
Article No.	Article Name	Article Image
424427	Bracket Post VGK 139	
amount	18	
load carrier	post pallet RP 120	
packaging method	6 wide, 3 up	
packaging aid	steel strap	
424438	Formwork Support VGK 100	
amount	20	
load carrier	wire crate k	
packaging method	5 wide, 4 up	
packaging aid	steel strap, wooden cover plate	
424447	Platform Cantilever Beam VGK 170	
amount	8	
load carrier	post pallet RP 150	
packaging method	4 wide, 2 up	
packaging aid	steel strap	
424455	Bracket Cantilever VGK 50	
amount	135	
load carrier	wire crate k	
packaging method	15 wide, 9 up	
packaging aid	steel strap, wooden cover plate	
424934	Brace Connector VGK	
amount	250	
load carrier	hardware box	
packaging method	loose	
packaging aid	steel strap, wooden cover plate	
425152	Bearing Frame VRB	
amount	2	
load carrier	post pallet RP 150	
packaging method	against each other	
packaging aid	steel strap, square timber	
425153	Coupling Joint Frame 1,5m VRB	
amount	1	
load carrier	loose	
packaging method	stacked	
packaging aid	steel strap, dunnage	

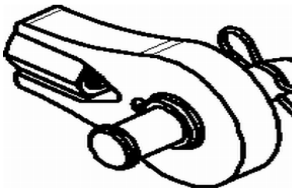
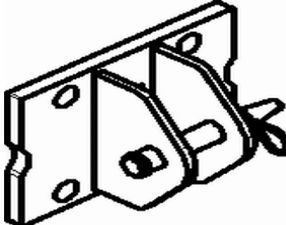
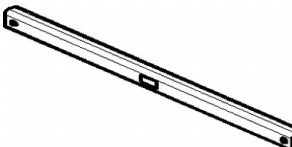
Article No.	Article Name	Article Image
425154	Coupling Joint Frame 3m VRB	
amount	1	
load carrier	loose	
packaging method	stacked	
packaging aid	steel strap, dunnage	
425155	Standard Frame 4,5m VRB	
amount	1	
load carrier	loose	
packaging method	stacked	
packaging aid	steel strap, dunnage	
425156	Standard Frame 6m VRB	
amount	1	
load carrier	loose	
packaging method	stacked	
packaging aid	steel strap, dunnage	
425413	Pressure Pole Starter VRB	
amount	32	
load carrier	post pallet RP 120	
packaging method	4 layers, 8 per layer	
packaging aid	steel strap, square timber between each layer	
425727	Eye Nut DW20 VRB	
amount	200	
load carrier	hardware box	
packaging method	loose	
packaging aid	steel strap, wooden cover plate	
425732	Coupling Shoe VRB	
amount	150	
load carrier	wire crate k	
packaging method	6 layers, 25 per layer	
packaging aid	steel strap, wooden cover plate	
425734	Bracing Post 1,5m VRB	
amount	48	
load carrier	post pallet RP 120	
packaging method	6 layers, 8 per layer	
packaging aid	steel strap, wooden strip between each layer	

Article No.	Article Name	Article Image
425736	Bracing Post 2,25m VRB	
amount	48	
load carrier	post pallet RP 120	
packaging method	6 layers, 8 per layer	
packaging aid	steel strap, wooden strip between each layer	
425741	Articulated Spanner DW20 VRB	
amount	50	
load carrier	hardware box	
packaging method	stacked	
packaging aid	steel strap, wooden cover plate	
425746	Coupling Post 0,5m VRB	
amount	250	
load carrier	hardware box	
packaging method	5 layers, 50 per layer	
packaging aid	steel strap, wooden cover plate	
425756	Coupling Post 1m VRB	
amount	240	
load carrier	wire crate k	
packaging method	15 layers, 16 per layer	
packaging aid	steel strap, wooden cover plate	
425764	Bracing Shoe VRB	
amount	84	
load carrier	wire crate k	
packaging method	4 layers, 21 per layer	
packaging aid	steel strap, wooden cover plate	
425770	Vertical Bracing Shoe VRB	
amount	39	
load carrier	wire crate k	
packaging method	3 layers, 13 per layer	
packaging aid	steel strap, wooden plate between each layer, wooden cover plate	
426050	Main Beam Connector VRB	
amount	6	
load carrier	wire crate k	
packaging method	3 layers, 2 per layer	
packaging aid	steel strap	

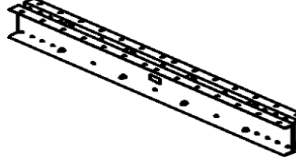
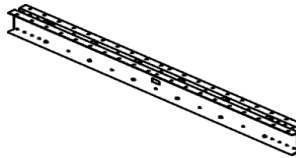
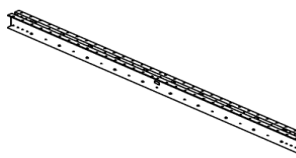
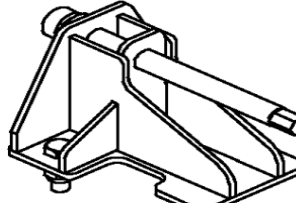
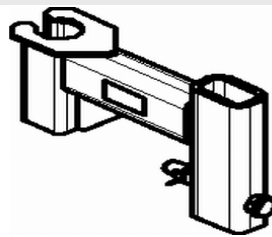
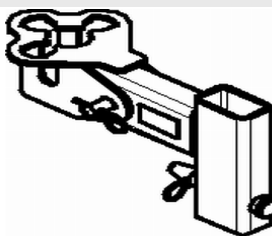
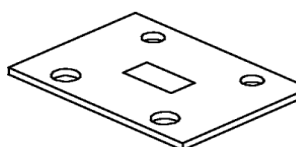
Article No.	Article Name	Article Image
426059	Main Beam 350 VRB	
amount	5	
load carrier	bundle	
packaging method	side by side	
packaging aid	steel strap, dunnage	
426062	Main Beam 500 VRB	
amount	5	
load carrier	bundle	
packaging method	side by side	
packaging aid	steel strap, dunnage	
426065	Main Beam 800 VRB	
amount	5	
load carrier	bundle	
packaging method	side by side	
packaging aid	steel strap, dunnage	
426173	Horizontal Bearing VRB	
amount	24	
load carrier	wire crate k	
packaging method	3 layers 8 per layer	
packaging aid	steel strap, wooden plate between each layer, wooden cover plate	
426345	Bracket Connector UP-VRB	
amount	50	
load carrier	wire crate k	
packaging method	stacked	
packaging aid	steel strap, wooden cover plate	
426355	Connector UP-VRB	
amount	50	
load carrier	wire crate k	
packaging method	stacked	
packaging aid	steel strap, wooden cover plate	
426402	Filler Plate VRB	
amount	360	
load carrier	hardware box	
packaging method	20 layers, 18 per layer	
packaging aid	steel strap, wooden cover plate	

Article No.	Article Name	Article Image
426578	Bearing Frame 6m VRB	
amount	1	
load carrier	loose	
packaging method	stacked	
packaging aid	steel strap, dunnage	
427136	Cross Fall Bearing VRB	
amount	45	
load carrier	hardware box	
packaging method	3 layers, 15 per layer	
packaging aid	steel strap, wooden cover plate	
427143	Longitudinal Bearing VRB	
amount	72	
load carrier	hardware box	
packaging method	3 layers, 24 per layer	
packaging aid	steel strap, wooden cover plate	
427285	Standard Frame 3m VRB	
amount	1	
load carrier	loose	
packaging method	stacked	
packaging aid	steel strap, dunnage	
427986	Leg VST 275	
amount	10	
load carrier	bundle	
packaging method	stacked	
packaging aid	steel strap, square timber, dunnage	
427987	Leg VST 175	
amount	10	
load carrier	bundle	
packaging method	stacked	
packaging aid	steel strap, square timber, dunnage	
427988	Leg VST 125	
amount	10	
load carrier	bundle	
packaging method	stacked	
packaging aid	steel strap, square timber, dunnage	

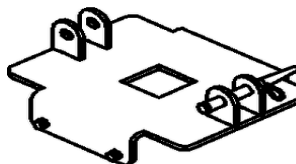
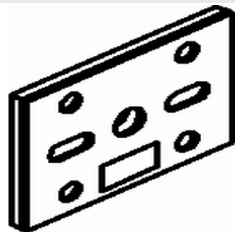
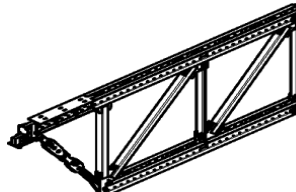
Article No.	Article Name	Article Image
427989	Leg VST 375	
amount	10	
load carrier	bundle	
packaging method	stacked	
packaging aid	steel strap, square timber, dunnage	
427990	Leg VST 525	
amount	10	
load carrier	bundle	
packaging method	stacked	
packaging aid	steel strap, square timber, dunnage	
427991	Leg VST 775	
amount	5	
load carrier	bundle	
packaging method	stacked	
packaging aid	steel strap, square timber, dunnage	
427992	Leg VST 1025	
amount	5	
load carrier	bundle	
packaging method	stacked	
packaging aid	steel strap, square timber, dunnage	
428019	Centering Plate HDT - VRB	
amount	48	
load carrier	wire crate k	
packaging method	8 layers, 6 per layer	
packaging aid	steel strap, wooden cover plate	
428025	Filler Plate Telescop Box VRB	
amount	180	
load carrier	hardware box	
packaging method	10 layers, 18 per layer	
packaging aid	steel strap, wooden cover plate	
428086	Bearing frame 5,25m VRB	
amount	1	
load carrier	loose	
packaging method	stacked	
packaging aid	steel strap, dunnage	

Article No.	Article Name	Article Image
428091	Bracing Traverse 150 VRB	
amount	10	
load carrier	wire crate k	
packaging method	5 layers, 2 per layer	
packaging aid	steel strap, wooden cover plate	
428098	Bracing Spindle VRB	
amount	80	
load carrier	wire crate k	
packaging method	5 layers, 16 per layer	
packaging aid	steel strap, wooden cover plate	
428103	Bracing Traverse Connector VRB	
amount	9	
load carrier	hardware box	
packaging method	3 layers, 3 per layer	
packaging aid	steel strap, wooden cover plate	

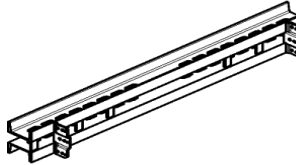
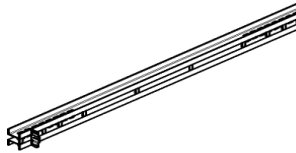
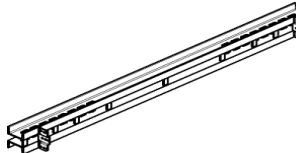
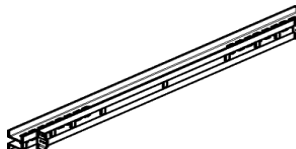
Article No.	Article Name	Article Image
310010	Steel Waler U100 SRZ 60 cm	
amount	50	
load carrier	wire crate k	
packaging method	stacked	
packaging aid	steel strap, wooden cover plate	
310020	Steel Waler U100 SRZ, 110 cm	
amount	30	
load carrier	wire crate k	
packaging method	stacked	
packaging aid	steel strap, wooden cover plate	
310030	Steel Waler SRZ U100, l = 1.20 m	
amount	24	
load carrier	bundle	
packaging method	6 wide, 4 up	
packaging aid	steel strap, dunnage (facing each other, 1.+4. layer log of wood 10x8x6)	
310040	Steel Waler SRZ U100, l = 2.20 m	
amount	24	
load carrier	bundle	
packaging method	6 wide, 4 up	
packaging aid	steel strap, dunnage (facing each other, 1.+4. layer log of wood 10x8x6)	
310050	Steel Waler SRZ U100, l = 2.45 m	
amount	24	
load carrier	bundle	
packaging method	6 wide, 4 up	
packaging aid	steel strap, dunnage (facing each other, 1.+4. layer log of wood 10x8x6)	
310060	Steel Waler SRZ U100, l = 1.825 m	
amount	24	
load carrier	bundle	
packaging method	6 wide, 4 up	
packaging aid	steel strap, dunnage (facing each other, 1.+4. layer log of wood 10x8x6)	
310070	Steel Waler SRZ U100, l = 1.95 m	
amount	24	
load carrier	bundle	
packaging method	6 wide, 4 up	
packaging aid	steel strap, dunnage (facing each other, 1.+4. layer log of wood 10x8x6)	

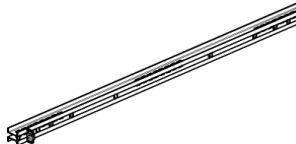
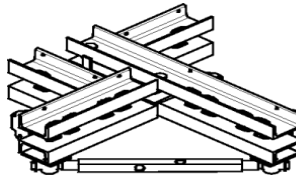
Article No.	Article Name	Article Image
310110	Steel Waler SRZ U100, l = 1.78 m	
amount	24	
load carrier	bundle	
packaging method	6 wide, 4 up	
packaging aid	steel strap, dunnage (facing each other, 1.+4. layer log of wood 10x8x6)	
310120	Steel Waler SRZ U100, l = 2.95 m	
amount	24	
load carrier	bundle	
packaging method	6 wide, 4 up	
packaging aid	steel strap, dunnage (facing each other, 1.+4. layer log of wood 10x8x6)	
310200	Internal Corner Waler IRZ 75/75	
amount	6	
load carrier	wire crate k	
packaging method	upright	
packaging aid	steel strap, wooden cover plate	
310360	Steel Waler U100 SRZ, 117 cm	
amount	30	
load carrier	wire crate k	
packaging method	stacked	
packaging aid	steel strap, wooden cover plate	
310370	Steel Waler SRZ U100, l = 2.39 m	
amount	24	
load carrier	bundle	
packaging method	6 wide, 4 up	
packaging aid	steel strap, dunnage (facing each other, 1.+4. layer log of wood 10x8x6)	
310380	Steel Waler SRZ U100, l = 3.61 m	
amount	24	
load carrier	bundle	
packaging method	6 wide, 4 up	
packaging aid	steel strap, dunnage (facing each other, 1.+4. layer log of wood 10x8x6)	
310390	Steel Waler SRZ U100, l = 4.83 m	
amount	24	
load carrier	bundle	
packaging method	6 wide, 4 up	
packaging aid	steel strap, dunnage (facing each other, 1.+4. layer log of wood 10x8x6)	

Article No.	Article Name	Article Image
310420	Steel Waler VSRZ-24 U100, I = 2.45/12	
amount	12	
load carrier	bundle	
packaging method	6 wide, 2 up	
packaging aid	steel strap, dunnage, each layer log of wood 10x8x6	
310440	Steel Waler VSRZ-24 U100, I = 1.20/12	
amount	12	
load carrier	bundle	
packaging method	6 wide, 2 up	
packaging aid	steel strap, dunnage, each layer log of wood 10x8x6	
310520	Steel Waler VSRZ-24 U100, I = 1.17/12	
amount	12	
load carrier	bundle	
packaging method	6 wide, 2 up	
packaging aid	steel strap, dunnage (facing each other)	
310530	Steel Waler VSRZ-24 U100, I = 2.39/12	
amount	12	
load carrier	bundle	
packaging method	6 wide, 2 up	
packaging aid	steel strap, dunnage (facing each other)	
310600	Steel Waler SRZ U100, I = 0.95 m	
amount	30	
load carrier	wire crate k	
packaging method	stacked	
packaging aid	steel strap, wooden cover plate	
310610	Steel Waler SRZ U100, I = 1.45 m	
amount	24	
load carrier	bundle	
packaging method	6 wide, 4 up	
packaging aid	steel strap, dunnage (facing each other, 1.+4. layer log of wood 10x8x6)	
311240	Steel Waler SRZ U120 I = 250-299 cm	
amount	12	
load carrier	bundle	
packaging method	6 wide, 2 up	
packaging aid	steel strap, square timber, wooden strip between each layer, log of wood	

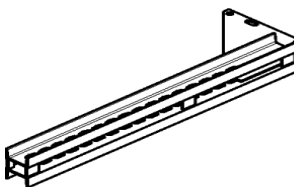
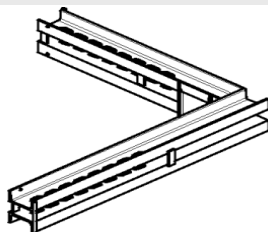
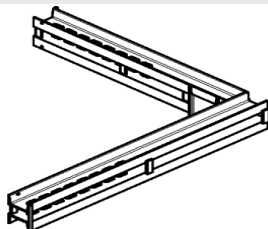
Article No.	Article Name	Article Image
311280	Steel Waler SRZ U120 l = 450-499 cm	
amount	12	
load carrier	bundle	
packaging method	6 wide, 2 up	
packaging aid	steel strap, square timber, wooden strip between each layer, log of wood	
312020	Column Waler SSRZ U-100. 146/141	
amount	20	
load carrier	bundle	
packaging method	stacked	
packaging aid	steel strap, dunnage	
312050	Column VARIO Waler SVRZ U-100, l = 1.20 m	
amount	12	
load carrier	bundle	
packaging method	6 wide, 2 up	
packaging aid	steel strap, dunnage	
312060	Column Main Waler SGRZ 181 cm	
amount	24	
load carrier	bundle	
packaging method	6 wide, 4 up	
packaging aid	steel strap, dunnage	
312080	Column Waler SSRZ U-100. spec. length	
amount	20	
load carrier	bundle	
packaging method	stacked	
packaging aid	steel strap, square timber	
312150	Column Waler SSRZ-24 U-100, l = 0.97/0.85 m	
amount	12	
load carrier	bundle	
packaging method	6 wide, 2 up	
packaging aid	steel strap, dunnage	
312160	Column Waler SSRZ-24 U-100, l = 1.13/1.01 m	
amount	12	
load carrier	bundle	
packaging method	6 wide, 2 up	
packaging aid	steel strap, dunnage	

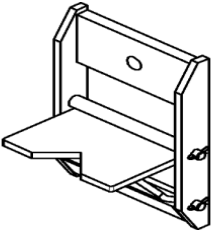
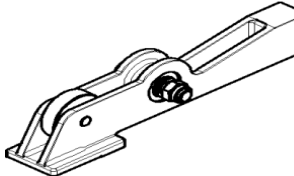
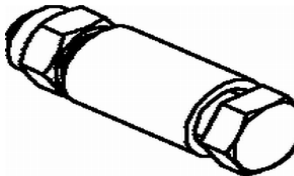
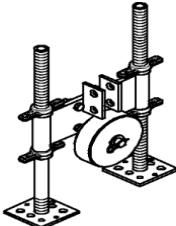
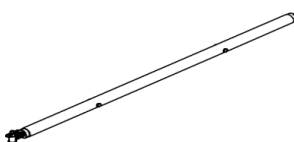
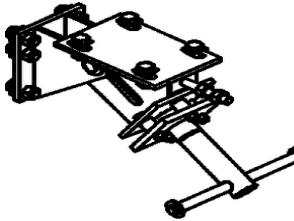
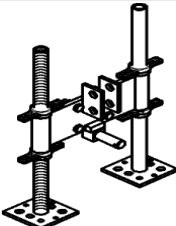
Article No.	Article Name	Article Image
320330	Folding Bearing Plate 25	
amount	50	
load carrier	hardware box	
packaging method	stacked	
packaging aid	steel strap, wooden cover plate	
320600	Gravity Pivot Plate BR	
amount	150	
load carrier	wire crate k	
packaging method	loose	
packaging aid	steel strap, wooden cover plate	
320620	Spacer for Platform Beam BR	
amount	1000	
load carrier	hardware box	
packaging method	loose	
packaging aid	steel strap, wooden cover plate	
322380	Double Spindle RKR with Wheel	
amount	16	
load carrier	wire crate k	
packaging method	stacked	
packaging aid	steel strap, wooden cover plate	
322400	Adjusting Spindle RKR, complete	
amount	as required	
load carrier	post pallet RP 150	
packaging method	stacked	
packaging aid	steel strap	
322410	Corner Spindle RKR	
amount	42	
load carrier	wire crate k	
packaging method	loose	
packaging aid	steel strap, wooden cover plate	
322440	Double Spindle RKR without Wheel	
amount	16	
load carrier	wire crate k	
packaging method	stacked	
packaging aid	steel strap, wooden cover plate	

Article No.	Article Name	Article Image
403868	Steel Waler Universal SRU U120, l = 0.72 m	
amount	42	
load carrier	wire crate k	
packaging method	stacked	
packaging aid	steel strap, wooden cover plate	
403871	Steel Waler Universal SRU U120, l = 0.97 m	
amount	30	
load carrier	wire crate k	
packaging method	stacked	
packaging aid	steel strap, wooden cover plate	
403874	Steel Waler Universal SRU U120, l = 1.22 m	
amount	15	
load carrier	post pallet RP 120	
packaging method	5 wide, 3 up	
packaging aid	steel strap, square timber, wooden strip between each layer, log of wood, tie every other layer, dunnage	
403877	Steel Waler Universal SRU U120, l = 1.47 m	
amount	15	
load carrier	post pallet RP 120	
packaging method	5 wide, 3 up	
packaging aid	steel strap, square timber, wooden strip between each layer, log of wood, tie every other layer, dunnage	
403886	Steel Waler Universal SRU U120, l = 1.72 m	
amount	15	
load carrier	post pallet RP 120	
packaging method	5 wide, 3 up	
packaging aid	steel strap, square timber, wooden strip between each layer, log of wood, tie every other layer, dunnage	
403889	Steel Waler Universal SRU U120, l = 1.97 m	
amount	15	
load carrier	post pallet RP 120	
packaging method	6 wide, 3 up	
packaging aid	steel strap, square timber, wooden strip between each layer, log of wood, tie every other layer, dunnage	
403892	Steel Waler Universal SRU U120, l = 2.47 m	
amount	15	
load carrier	post pallet RP 150	
packaging method	5 wide, 3 up	
packaging aid	steel strap, square timber, wooden strip between each layer, log of wood, tie every other layer, dunnage	

Article No.	Article Name	Article Image
403898	Steel Waler Universal SRU U120, l = 2.22 m	
amount	15	
load carrier	post pallet RP 150	
packaging method	5 wide, 3 up	
packaging aid	steel strap, square timber, wooden strip between each layer, log of wood, tie every other layer, dunnage	
403903	Steel Waler Universal SRU U120, l = 2.97 m	
amount	15	
load carrier	post pallet RP 150	
packaging method	5 wide, 3 up	
packaging aid	steel strap, square timber, wooden strip between each layer, log of wood, tie every other layer, dunnage	
403906	Steel Waler Universal SRU U120, l = 3.47 m	
amount	15	
load carrier	post pallet RP 150	
packaging method	5 wide, 3 up	
packaging aid	steel strap, square timber, wooden strip between each layer, log of wood, tie every other layer, dunnage	
403915	Steel Waler Universal SRU U120, l = 3.97 m	
amount	10	
load carrier	bundle	
packaging method	5 wide, 2 up	
packaging aid	steel strap, square timber, wooden strip between each layer, log of wood, tie every other layer, dunnage	
403918	Steel Waler Universal SRU U120, l = 4.47 m	
amount	10	
load carrier	bundle	
packaging method	5 wide, 2 up	
packaging aid	steel strap, square timber, wooden strip between each layer, log of wood, tie every other layer, dunnage	
403922	Steel Waler Universal SRU U120, l = 4.97 m	
amount	10	
load carrier	bundle	
packaging method	5 wide, 2 up	
packaging aid	steel strap, square timber, wooden strip between each layer, log of wood, tie every other layer, dunnage	
403925	Steel Waler Universal SRU U120, l = 5.47 m	
amount	10	
load carrier	bundle	
packaging method	5 wide, 2 up	
packaging aid	steel strap, square timber, wooden strip between each layer, log of wood, tie every other layer, dunnage	

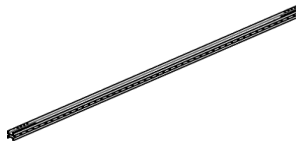
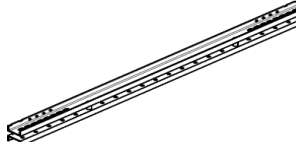
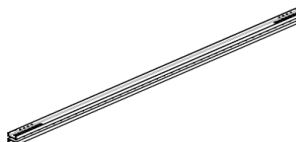
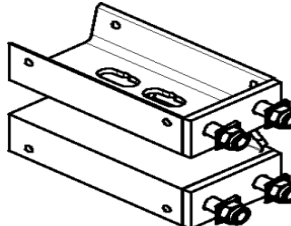
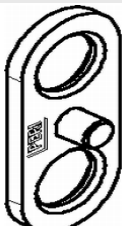
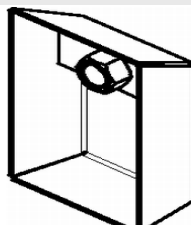
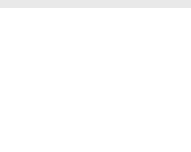
Article No.	Article Name	Article Image
403928	Steel Waler Universal SRU U120, l = 5.97 m	
amount	10	
load carrier	bundle	
packaging method	5 wide, 2 up	
packaging aid	steel strap, square timber, wooden strip between each layer, log of wood, tie every other layer, dunnage	
403929	Steel Waler Universal SRU U120, l = 2.72 m	
amount	15	
load carrier	post pallet RP 150	
packaging method	5 wide, 3 up	
packaging aid	steel strap, square timber, wooden strip between each layer, log of wood, tie every other layer, dunnage	
403943	Steel Waler Universal SRU U140, l = 4.97 m	
amount	10	
load carrier	bundle	
packaging method	5 wide, 2 up	
packaging aid	steel strap, square timber, wooden strip between each layer, log of wood, tie every other layer, dunnage	
404027	Extension VARIO 24 U120	
amount	105	
load carrier	wire crate k	
packaging method	5 layers, 3 x 7 per layer	
packaging aid	steel strap, wooden cover plate	
405401	Crane Eye BR 2.5 t	
amount	500	
load carrier	wire crate k	
packaging method	loose	
packaging aid	steel strap, wooden cover plate	
408162	Bearing Box BR	
amount	250	
load carrier	wire crate k	
packaging method	stacked	
packaging aid	steel strap, wooden cover plate	
411041	Steel Waler SRZ 115	
amount	30	
load carrier	wire crate k	
packaging method	stacked	
packaging aid	steel strap, wooden cover plate	

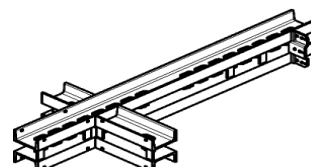

Article No.	Article Name	Article Image
411047	Steel Waler SRZ, U100, l = 2.35 m	
amount	24	
load carrier	bundle	
packaging method	6 wide, 4 up	
packaging aid	steel strap, dunnage (facing each other, 1.+4. layer log of wood 10x8x6)	
411052	Steel Waler VSRZ-24, l = 115/12	
amount	12	
load carrier	bundle	
packaging method	6 wide, 2 up	
packaging aid	steel strap, dunnage (facing each other)	





Article No.	Article Name	Article Image
400954	Table Swivel Head, Middle Part	
amount	36	
load carrier	wire crate k	
packaging method	stacked	
packaging aid	steel strap, wooden cover plate	
400955	Modul Swivel Head, Upper Part	
amount	60	
load carrier	wire crate k	
packaging method	stacked	
packaging aid	steel strap, wooden cover plate	
400956	Table Swivel Head, Lower Part	
amount	36	
load carrier	wire crate k	
packaging method	stacked	
packaging aid	steel strap, wooden cover plate	
408108	PERI Table Lift PTL 1250	
amount	1	
load carrier	loose	
packaging method	loose	
packaging aid		
412498	Swivel Head SRU	
amount	40	
load carrier	wire crate k	
packaging method	loose	
packaging aid	steel strap, wooden cover plate	
413733	PERI Table Lift PTL	
amount	1	
load carrier	loose	
packaging method	loose	
packaging aid		
417176	Table Head Upper Part VD	
amount	170	
load carrier	wire crate k	
packaging method	stacked	
packaging aid	steel strap, wooden cover plate	

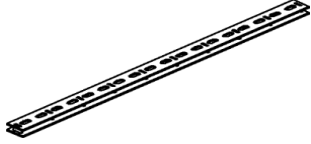
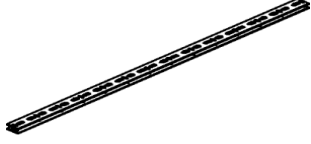
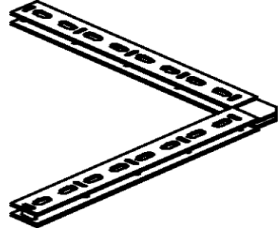
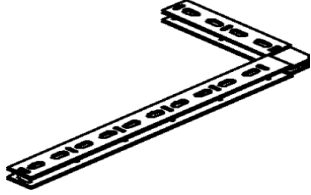

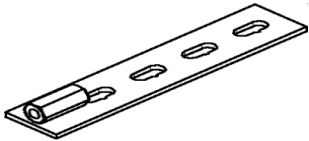
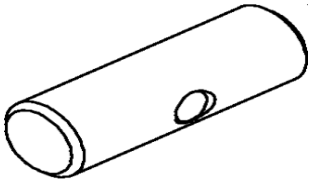
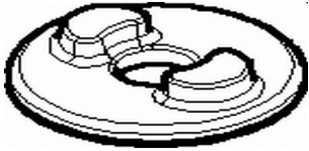
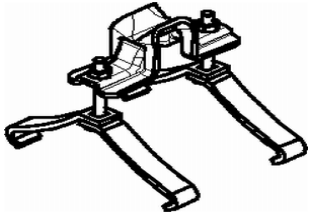
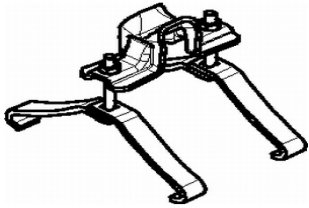
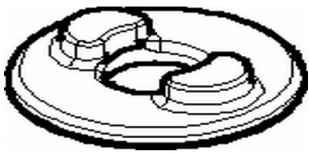

Article No.	Article Name	Article Image
417185	Table Head Middle Part VD	
amount	36	
load carrier	wire crate k	
packaging method	stacked	
packaging aid	steel strap, wooden cover plate	
417189	Edge Protector, galv.	
amount	54	
load carrier	wire crate k	
packaging method	stacked	
packaging aid	steel strap, wooden cover plate	
417193	Table VD 200/215 x 600	
amount	1	
load carrier	loose	
packaging method	stacked	
packaging aid		
417308	Table VD 250/265 x 600	
amount	1	
load carrier	loose	
packaging method	stacked	
packaging aid		
417336	Table VD 200/215 x 400	
amount	1	
load carrier	loose	
packaging method	stacked	
packaging aid		
417337	Table VD 250/265 x 400	
amount	1	
load carrier	loose	
packaging method	stacked	
packaging aid		
417576	Coupling VD	
amount	200	
load carrier	post pallet RP 150	
packaging method	stacked	
packaging aid	steel strap	

Article No.	Article Name	Article Image
423796	Support Plate VD	
amount	256	
load carrier	wire crate k	
packaging method	16 layers, 16 per layer	
packaging aid	steel strap, wooden plate between each layer, wooden cover plate	

Article No.	Article Name	Article Image
313010	Coupling VKZ 99	
amount	160	
load carrier	wire crate k	
packaging method	stacked	
packaging aid	steel strap, wooden cover plate	
313020	Coupling VKZ 147	
amount	72	
load carrier	post pallet RP 120	
packaging method	9 wide, 8 up	
packaging aid	steel strap, wooden strip between each layer	
313030	Coupling VKZ 211	
amount	72	
load carrier	post pallet RP 150	
packaging method	9 wide, 8 up	
packaging aid	steel strap, wooden strip between each layer	
313130	Corner Coupling EKZ 76/76	
amount	35	
load carrier	wire crate k	
packaging method	stacked	
packaging aid	steel strap, wooden cover plate	
313140	Corner Coupling EKZ 95/43	
amount	68	
load carrier	wire crate k	
packaging method	stacked	
packaging aid	steel strap, wooden cover plate	
313210	Articulated Coupling GKZ 76/76	
amount	72	
load carrier	post pallet RP 120	
packaging method	8 wide 9 up	
packaging aid	steel strap, wooden strip between each layer	
313220	Articulated Coupling GKZ 60/60	
amount	130	
load carrier	wire crate k	
packaging method	9 wide, 14 up + 4	
packaging aid	steel strap, wooden cover plate	

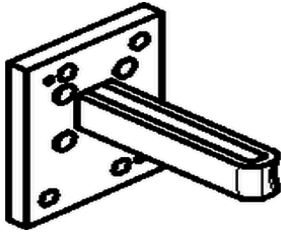
Article No.	Article Name	Article Image
401395	Offset Coupling VVKZ 3/99	
amount	150	
load carrier	wire crate k	
packaging method	stacked	
packaging aid	steel strap, wooden cover plate	
402825	VARIO Coupling Concrete Finish VKS 99	
amount	160	
load carrier	wire crate k	
packaging method	9 wide, 17 up + 7 on the side	
packaging aid	steel strap, wooden cover plate	
402945	VARIO Alignment Clamp VRS	
amount	200	
load carrier	hardware box	
packaging method	loose	
packaging aid	steel strap, wooden cover plate	
403054	Articulated Coupling GKS 60/60 S	
amount	130	
load carrier	wire crate k	
packaging method	9 wide, 14 up + 4	
packaging aid	steel strap, wooden cover plate	
403737	Universal Coupling UK 70	
amount	70	
load carrier	wire crate k	
packaging method	5 wide, 14 up	
packaging aid	steel strap, wooden cover plate	
403850	Outside Corner Coupling AKZ 85/85	
amount	33	
load carrier	wire crate k	
packaging method	stacked	
packaging aid	steel strap, wooden cover plate	
403938	Corner Coupling EKZ 47/43	
amount	100	
load carrier	wire crate k	
packaging method	stacked	
packaging aid	steel strap, wooden cover plate	

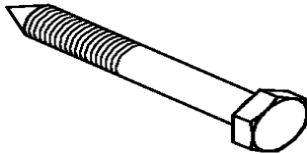

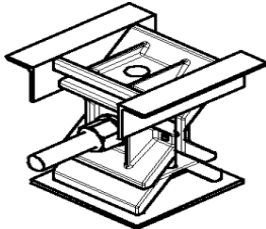
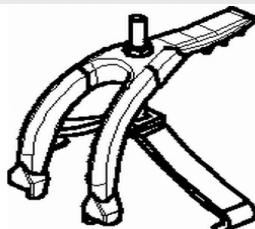
Article No.	Article Name	Article Image
313240	Stopend Tie	
amount	500	
load carrier	wire crate k	
packaging method	loose	
packaging aid	steel strap, wooden cover plate	
322030	Tie Yoke, galv.	
amount	500	
load carrier	hardware box	
packaging method	loose	
packaging aid	steel strap, wooden cover plate	
324000	Compensation Washer 16, yellow galv.	
amount	1000	
load carrier	hardware box	
packaging method	10 bags, 100 per bag	
packaging aid	steel strap, wooden cover plate	
324070	Hook Strap HB 24-100/120, galv.	
amount	1000	
load carrier	wire crate k	
packaging method	loose	
packaging aid	steel strap, wooden cover plate, packed in foil	
324080	Hook Strap HB 24-140/160, galv.	
amount	1000	
load carrier	wire crate k	
packaging method	loose	
packaging aid	steel strap, wooden cover plate, packed in foil	
324180	Compensation Washer 20, galv.	
amount	1000	
load carrier	hardware box	
packaging method	10 bags, 100 per bag	
packaging aid	steel strap, wooden cover plate	
324210	Tie Yoke SKZ	
amount	600	
load carrier	wire crate k	
packaging method	loose	
packaging aid	steel strap, wooden cover plate	

Article No.	Article Name	Article Image
324220	Coupling Compression Plate KDP	
amount	300	
load carrier	hardware box	
packaging method	stacked	
packaging aid	steel strap, wooden cover plate	
324240	Wedge KZ, galv.	
amount	500	
load carrier	hardware box	
packaging method	50 bundles, 10 per bundle	
packaging aid	steel strap, wooden cover plate	
324250	Wedge K, galv.	
amount	500	
load carrier	hardware box	
packaging method	50 nudles, 10 per bundle	
packaging aid	steel strap, wooden cover plate	
324270	Lag Screw DIN 571 8 x 60, galv.	
amount	1000	
load carrier	hardware box	
packaging method	loose	
packaging aid	steel strap, wooden cover plate	
324480	Extension Splice 24-2	
amount	60	
load carrier	wire crate k	
packaging method	stacked offset	
packaging aid	steel strap	
324590	Wedge Lowering Device 420 kN	
amount	42	
load carrier	wire crate k	
packaging method	3 layers, 14 per layer, drilled out	
packaging aid	steel strap, wooden cover plate	
324600	Girder Claw HB	
amount	1000	
load carrier	wire crate k	
packaging method	loose	
packaging aid	steel strap, wooden cover plate	

Article No.	Article Name	Article Image
324630	Fix Strap U100 – U120, galv.	
amount	1000	
load carrier	wire crate k	
packaging method	loose	
packaging aid	steel strap, wooden cover plate	
324640	Quick Str. Hook Strap 24-100/140, galv.	
amount	500	
load carrier	hardware box	
packaging method	loose	
packaging aid	steel strap, wooden cover plate	
324880	HOOK STRAP HB FOR VT, GALV.	
amount	1000	
load carrier	wire crate k	
packaging method	loose	
packaging aid	steel strap, wooden cover plate	
325220	Quick Release Corner SSE 3.0 m	
amount	6	
load carrier	post pallet RP 150	
packaging method	3 wide, 2 up	
packaging aid	steel strap	
325230	Quick Release Corner SSE 4.0 m	
amount	6	
load carrier	post pallet RP 150	
packaging method	3 wide, 2 up	
packaging aid	steel strap	
370740	Erection Bar GT/VT, galv.	
amount	1	
load carrier	loose	
packaging method	loose	
packaging aid		
370760	Crane Splice GT 24	
amount	100	
load carrier	wire crate k	
packaging method	stacked	
packaging aid	steel strap, wooden cover plate	

Article No.	Article Name	Article Image
401290	Guardrail Holder GT 24 / VT 20	
amount	100	
load carrier	wire crate k	
packaging method	stacked	
packaging aid	steel strap, wooden cover plate	
403845	Hook Strap Uni HBU 24-28	
amount	200	
load carrier	wire crate k	
packaging method	loose	
packaging aid	steel strap, wooden cover plate, packed in foil	
404031	Fitting Pin Ø 21 x 120	
amount	1500	
load carrier	hardware box	
packaging method	loose	
packaging aid	steel strap, wooden cover plate	
404096	Hook Strap Uni Double HBUD 24-28	
amount	200	
load carrier	wire crate k	
packaging method	loose	
packaging aid	steel strap, wooden cover plate, packed in foil	
404131	Guardrail Holder SRU/SRZ	
amount	100	
load carrier	wire crate k	
packaging method	stacked	
packaging aid	steel strap, wooden cover plate	
404930	Hook Strap Uni Double HBUD 20-24	
amount	200	
load carrier	wire crate k	
packaging method	loose	
packaging aid	steel strap, wooden cover plate, packed in foil	
404931	Hook Strap Uni HBU 20-24	
amount	200	
load carrier	wire crate k	
packaging method	loose	
packaging aid	steel strap, wooden cover plate, packed in foil	

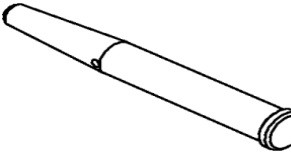
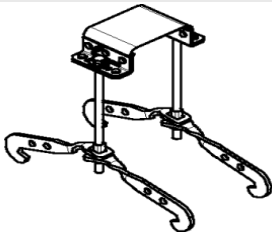
Article No.	Article Name	Article Image
409630	Spindle Head SRU	
amount	200	
load carrier	wire crate k	
packaging method	loose	
packaging aid	steel strap, wooden cover plate	
410755	Tie Yoke SRU	
amount	240	
load carrier	hardware box	
packaging method	loose	
packaging aid	steel strap, wooden cover plate	
410756	Tie Yoke Head SRU	
amount	112	
load carrier	wire crate k	
packaging method	4 wide, 28 up	
packaging aid	steel strap, wooden plate between each layer, wooden cover plate	
410765	Adjustable Brace SRU I = 1,65 - 2,4 m	
amount	20	
load carrier	post pallet RP 120	
packaging method	4 wide, 5 up	
packaging aid	steel strap, wooden strip between each layer	
411000	Tension Strap MPB 24 / GT 24	
amount	250	
load carrier	hardware box	
packaging method	loose	
packaging aid	steel strap, wooden cover plate	
411135	Adjusting Unit SRU, internal	
amount	100	
load carrier	hardware box	
packaging method	loose	
packaging aid	steel strap, wooden cover plate	
411238	Crane Hook 2 t / GT 24	
amount	25	
load carrier	wire crate k	
packaging method	loose	
packaging aid	steel strap, wooden cover plate	

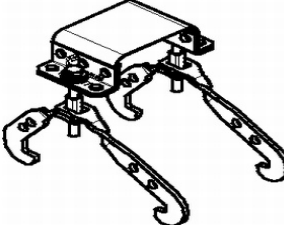
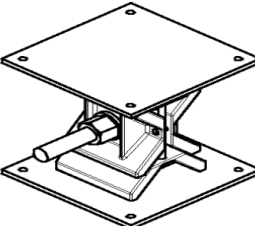
Article No.	Article Name	Article Image
411567	Fitting Pin Ø 26 x 120	
amount	1500	
load carrier	hardware box	
packaging method	loose	
packaging aid	steel strap, wooden cover plate	
411806	Hook Strap Uni HBU 24-26 U200	
amount	200	
load carrier	wire crate k	
packaging method	loose	
packaging aid	steel strap, wooden cover plate, packed in foil	
413712	Crane Lifting Unit-2 VT20, galv.	
amount	100	
load carrier	hardware box	
packaging method	loose	
packaging aid	steel strap, wooden cover plate	
415544	Hook Strap Uni HBU 14-17	
amount	200	
load carrier	wire crate k	
packaging method	loose	
packaging aid	steel strap, wooden cover plate	
417930	Wedge Lowering Device 1000 kN, painted	
amount	16	
load carrier	wire crate k	
packaging method	2 layers, 8 per layer, drilled out	
packaging aid	steel strap, wooden cover plate	

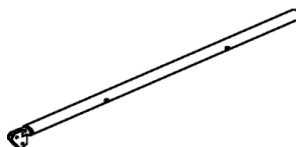
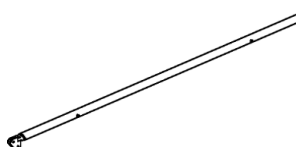
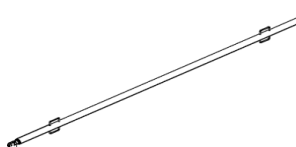
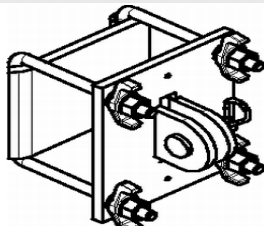
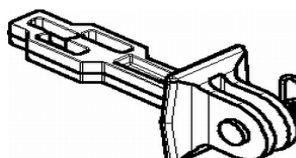
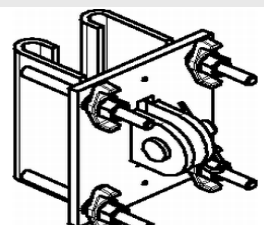
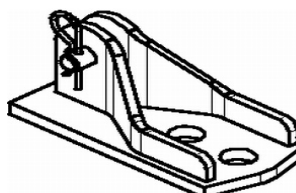
Article No.	Article Name	Article Image
328010	Push-Pull Prop RSS I	
amount	54	
load carrier	post pallet RP 150	
packaging method	9 wide, 6 up	
packaging aid	steel strap, wooden strip between each layer	
328020	Push-Pull Prop RSS II	
amount	54	
load carrier	post pallet RP 150	
packaging method	9 wide, 6 up	
packaging aid	steel strap, wooden strip between each layer	
328030	Push-Pull Prop RSS III	
amount	38	
load carrier	post pallet RP 150	
packaging method	8 wide, 4 up + 6	
packaging aid	steel strap, wooden strip between each layer	
328050	Girder Headpiece GT 24, galv.	
amount	200	
load carrier	wire crate k	
packaging method	loose	
packaging aid	steel strap, wooden cover plate	
328060	Wedge Headpiece SRZ/SRU	
amount	650	
load carrier	wire crate k	
packaging method	loose	
packaging aid	steel strap, wooden cover plate	
328070	Girder Headpiece GT 24 / A, galv.	
amount	200	
load carrier	wire crate k	
packaging method	loose	
packaging aid	steel strap, wooden cover plate	
328080	Connector Kicker/Push-Pull Prop, galv.	
amount	192	
load carrier	hardware box	
packaging method	2 layers, 96 per layer	
packaging aid	steel strap, wooden plate between each layer, wooden cover plate	

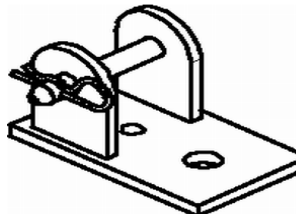
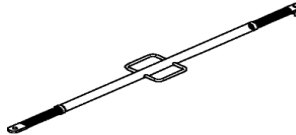
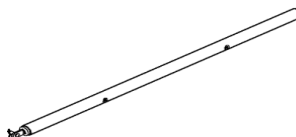
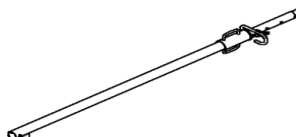
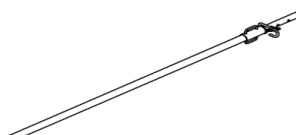
Article No.	Article Name	Article Image
328090	Base Plate for RSS	
amount	800	
load carrier	wire crate k	
packaging method	loose	
packaging aid	steel strap, wooden cover plate	
328100	Base Plate for RS	
amount	700	
load carrier	wire crate k	
packaging method	loose	
packaging aid	steel strap, wooden cover plate	
328110	Kicker AV 140	
amount	144	
load carrier	wire crate k	
packaging method	stacked	
packaging aid	steel strap, wooden cover plate	
328120	Kicker AV RSS III	
amount	54	
load carrier	post pallet RP 150	
packaging method	9 wide, 6 up	
packaging aid	steel strap, wooden strip between each layer	
328210	Push-Pull Prop RS I	
amount	50	
load carrier	post pallet RP 150	
packaging method	stacked	
packaging aid	steel strap, wooden strip between each layer	
328220	Push-Pull Prop RS II	
amount	50	
load carrier	post pallet RP 150	
packaging method	stacked	
packaging aid	steel strap, wooden strip between each layer	
328270	Kicker AV 190	
amount	100	
load carrier	post pallet RP 120	
packaging method	stacked	
packaging aid	steel strap, wooden strip between each layer	

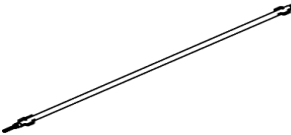
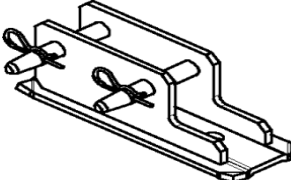
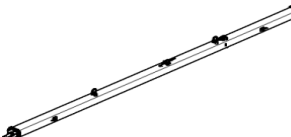
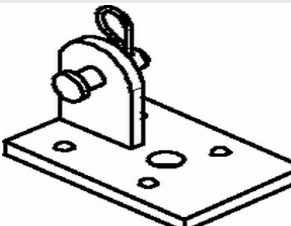
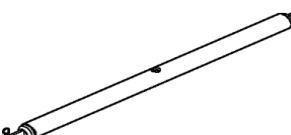
Article No.	Article Name	Article Image
328900	Base Plate for RS 1000, galv.	
amount	200	
load carrier	wire crate k	
packaging method	loose	
packaging aid	steel strap, wooden cover plate	
328990	Push-Pull Prop RS 1000, galv.	
amount	10	
load carrier	post pallet RP 150	
packaging method	6 wide, 2 up	
packaging aid	steel strap, 2x square timber per layer (10 cm outside the post pallet)	
402018	Base Plate-2 for RS 1000/1400, galv.	
amount	200	
load carrier	wire crate k	
packaging method	loose	
packaging aid	steel strap, wooden cover plate	
403800	Push-Pull Prop RS 1400, galv.	
amount	6	
load carrier	bundle	
packaging method	5 wide, 1 up	
packaging aid	3 x steel strap, double dunnage	
406000	Base Plate-2 for RSS, galv.	
amount	220	
load carrier	hardware box	
packaging method	stacked	
packaging aid	steel strap, wooden cover plate	
408135	Kicker AV 210	
amount	54	
load carrier	post pallet RP 120	
packaging method	9 wide, 6 up	
packaging aid	steel strap, square timber	
414359	Girder Headpiece GT 24 / MPB / VT20-D	
amount	100	
load carrier	wire crate k	
packaging method	loose	
packaging aid	steel strap, wooden cover plate	

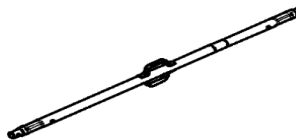
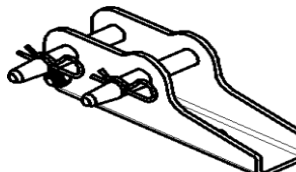

Article No.	Article Name	Article Image
417343	Base Plate-2 for RS 210 – 1400, galv.	
amount	200	
load carrier	wire crate k	
packaging method	6 layers, 33 per layer + 2	
packaging aid	steel strap, wooden plate between each layer, wooden cover plate	
417466	Push-Pull Prop RS 210, galv.	
amount	55	
load carrier	post pallet RP 120	
packaging method	stacked	
packaging aid	steel strap	
417467	Push-Pull Prop RS 300, galv.	
amount	56	
load carrier	post pallet RP 150	
packaging method	10 wide, 5 up	
packaging aid	steel strap, square timber	
417468	Push-Pull Prop RS 450, galv.	
amount	45	
load carrier	post pallet RP 150	
packaging method	9 wide, 5 up / each layer crosswise stacked	
packaging aid	steel strap, square timber	
417469	Push-Pull Prop RS 650, galv.	
amount	24	
load carrier	post pallet RP 150	
packaging method	6 wide, 4 up	
packaging aid	steel strap, square timber	
417470	Quick Connector Head RS	
amount	200	
load carrier	wire crate k	
packaging method	loose	
packaging aid	steel strap, wooden cover plate	
417726	Push-Pull Prop Adaptor RS	
amount	200	
load carrier	hardware box	
packaging method	loose	
packaging aid	steel strap, wooden cover plate	

Article No.	Article Name	Article Image
418238	Push-Pull Prop RS 260, galv.	
amount	55	
load carrier	post pallet RP 150	
packaging method	11 wide, 5 up / crosswise stacked	
packaging aid	steel strap, square timber	
426666	Base Plate-3 for RS 210 – 1400, galv.	
amount	200	
load carrier	wire crate k	
packaging method	6 layers, 33 per layer + 2	
packaging aid	steel strap, wooden plate between each layer, wooden cover plate	

Article No.	Article Name	Article Image
326035	Climbing Bracket KG 180, compl.	
amount	6	
load carrier	bundle	
packaging method	upright	
packaging aid	connected with scaffold tube	
326040	Cantilever Beam KG 180	
amount	30	
load carrier	wire crate k	
packaging method	loose	
packaging aid	steel strap	
326055	Climbing Bracket KG 240, compl.	
amount	6	
load carrier	bundle	
packaging method	upright	
packaging aid	connected with scaffold tube	
326060	Cantilever Beam KG 240	
amount	30	
load carrier	wire crate k	
packaging method	loose	
packaging aid	steel strap	
326075	Post Extension 150 for KG 180, compl.	
amount	20	
load carrier	bundle	
packaging method	10 wide, 2 up / left-right shifted	
packaging aid	dunnage	
326085	Post Extension 150 for KG 240, compl.	
amount	20	
load carrier	bundle	
packaging method	10 wide, 2 up / left-right shifted	
packaging aid	dunnage	
326180	Bracket KG 130	
amount	10	
load carrier	post pallet RP 120	
packaging method	stacked	
packaging aid	steel strap	

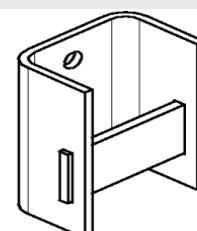
Article No.	Article Name	Article Image
326512	Corner Platform ASE	
amount	1	
load carrier	loose	
packaging method	loose	
packaging aid		
326520	Bracket ASG 160	
amount	10	
load carrier	post pallet RP 150	
packaging method	stacked	
packaging aid	steel strap	
326521	Support Extension 370 ASG	
amount	24	
load carrier	post pallet RP 150	
packaging method	4 wide, 6 up	
packaging aid	steel strap	
326522	Compression Strut ASG	
amount	78	
load carrier	post pallet RP 150	
packaging method	13 wide, 6 up	
packaging aid	steel strap	
326528	Guardrail Holder 105 ASG	
amount	120	
load carrier	wire crate k	
packaging method	loose	
packaging aid		
326531	Wall Scaffold Hinge ASG	
amount	120	
load carrier	wire crate k	
packaging method	6 layers, 20 per layer	
packaging aid	steel strap, wooden cover plate	
326535	Height Adjusting ASG	
amount	12	
load carrier	post pallet RP 150	
packaging method	4 wide, 3 up / against each other	
packaging aid	steel strap	

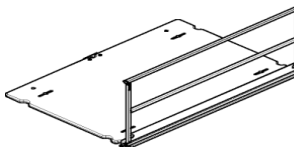

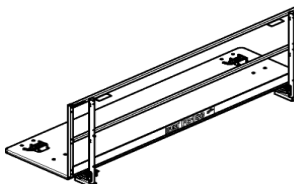

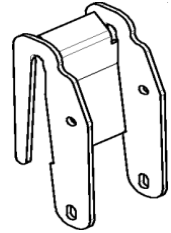
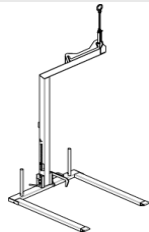
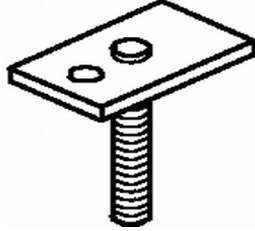
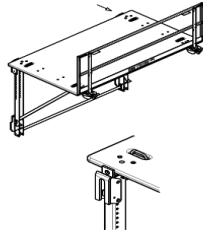
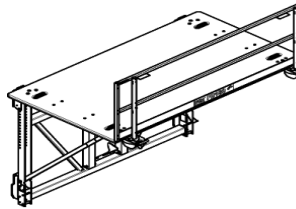
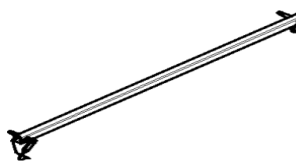
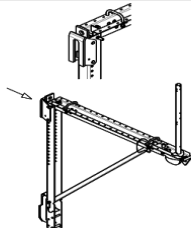

Article No.	Article Name	Article Image
326580	Main Platform ASG 160/240 Lattice	
amount	1	
load carrier	loose	
packaging method	loose	
packaging aid		
326581	Intermediate Platform ASZ 240 Lattice	
amount	1	
load carrier	loose	
packaging method	loose	
packaging aid		
326583	Guardrail Extension ASG	
amount	15	
load carrier	post pallet RP 120	
packaging method	crosswise stacked	
packaging aid	steel strap	
326622	Intermediate Platform FBZ 240	
amount	1	
load carrier	loose	
packaging method	stacked	
packaging aid	steel strap	
326623	Support Extension 200 FB-2, galv.	
amount	16	
load carrier	post pallet RP 150	
packaging method	4 wide, 4 up	
packaging aid	steel strap	
326624	Support Extension 300 FB-2, galv.	
amount	12	
load carrier	post pallet RP 150	
packaging method	3 wide, 4 up	
packaging aid	steel strap, wooden strip between each layer	
326625	Finishing Platform FBN-2/300	
amount	1	
load carrier	loose	
packaging method	loose	
packaging aid		



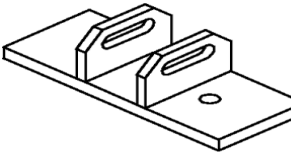
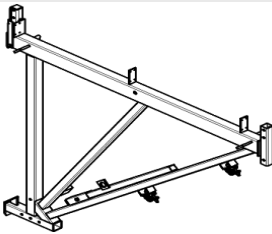
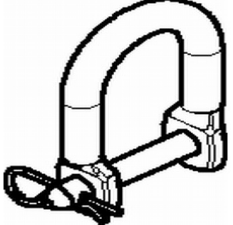
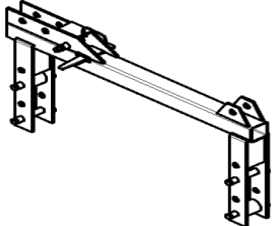
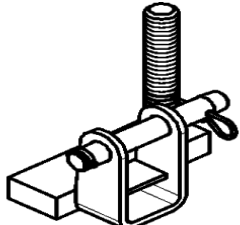

Article No.	Article Name	Article Image
326626	Corner Frame FBE	
amount	10	
load carrier	bundle	
packaging method	stacked	
packaging aid	steel strap	
326627	Compression Strut FB-2	
amount	30	
load carrier	post pallet RP 150	
packaging method	6 wide, 5 up / contrary	
packaging aid	steel strap	
326628	Guardrail Post FBP	
amount	72	
load carrier	wire crate k	
packaging method	6 layers, 12 per layer	
packaging aid	steel strap, wooden plate between each layer, wooden cover plate	
326631	Finishing Platform Bracket FBN-2	
amount	8	
load carrier	post pallet RP 120	
packaging method	4 wide, 2 up	
packaging aid	steel strap	
326632	Mounting Head FB	
amount	144	
load carrier	wire crate k	
packaging method	4 layers, 36 per layer	
packaging aid	steel strap, wooden plate between each layer, wooden cover plate	
326635	Guardrail Extension FB	
amount	150	
load carrier	wire crate k	
packaging method	stacked	
packaging aid	steel strap, square timber	
326644	Pipe Bracing Connector, galv.	
amount	250	
load carrier	hardware box	
packaging method	loose	
packaging aid	steel strap, wooden cover plate	

Article No.	Article Name	Article Image
326645	Loop Mounting Head-2 FB, galv.	
amount	100	
load carrier	wire crate k	
packaging method	5 layers, 20 per layer	
packaging aid	steel strap, wooden plate between each layer, wooden cover plate	
326646	Transportation Fork FB, galv.	
amount	1	
load carrier	loose	
packaging method	loose	
packaging aid		
326647	Screw Plate DW 15/115, galv.	
amount	500	
load carrier	hardware box	
packaging method	loose	
packaging aid	steel strap, wooden cover plate	
326648	Folding Platform FB 180 – 3/300	
amount	1	
load carrier	loose	
packaging method	stacked	
packaging aid		
326649	Folding Corner Platform FEB 180 – 3/300	
amount	1	
load carrier	loose	
packaging method	stacked	
packaging aid		
326651	Bracket Strut FB 180-3	
amount	78	
load carrier	post pallet RP 150	
packaging method	13 wide, 6 up	
packaging aid	steel strap	
326652	Folding Bracket FB 180 – 3, compl.	
amount	8	
load carrier	post pallet RP 120	
packaging method	4 wide, 2 up	
packaging aid	steel strap	

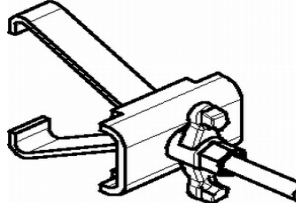
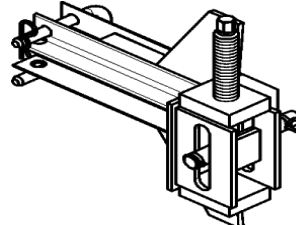
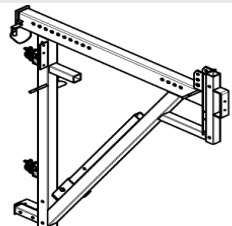
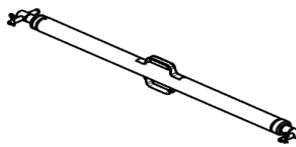
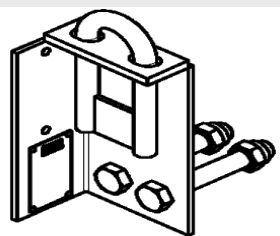
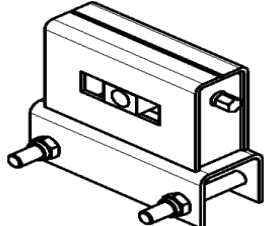
Article No.	Article Name	Article Image
326990	Wall Scaffold Hinge FB	
amount	360	
load carrier	wire crate k	
packaging method	10 layers, 36 per layer	
packaging aid	steel strap, wooden cover plate	
327010	Carriage FW	
amount	6	
load carrier	post pallet RP 120	
packaging method	2 wide, 3 up	
packaging aid	steel strap	
327030	Articulated Joint GT 24	
amount	10	
load carrier	wire crate k	
packaging method	stacked	
packaging aid	steel strap, wooden cover plate	
327040	Articulated Joint TRIO	
amount	10	
load carrier	wire crate k	
packaging method	loose	
packaging aid	steel strap, wooden cover plate	
327060	Corner Scaffold Bracket EGB 24 – 80, right	
amount	12	
load carrier	post pallet RP 150	
packaging method	stacked	
packaging aid	steel strap	
327070	Corner Scaffold Bracket EGB 24 – 80, left	
amount	12	
load carrier	post pallet RP 150	
packaging method	stacked	
packaging aid	steel strap	
327110	Scaffold Bracket GB 80	
amount	16	
load carrier	post pallet RP 120	
packaging method	stacked	
packaging aid	steel strap, left - right shifted	

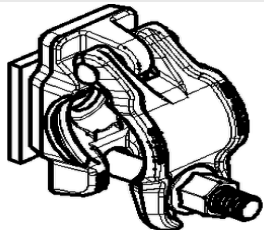
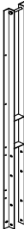
Article No.	Article Name	Article Image
327150	Locating Shoe for Articulated Joint KG	
amount	100	
load carrier	hardware box	
packaging method	loose	
packaging aid	steel strap, wooden cover plate	
351000	Climbing Bracket CB 240	
amount	1	
load carrier	loose	
packaging method	stacked	
packaging aid		
351010	Lifting Eye CB 240	
amount	300	
load carrier	hardware box	
packaging method	loose	
packaging aid	steel strap, wooden cover plate	
351020	Carriage CB 240	
amount	10	
load carrier	bundle	
packaging method	side by side	
packaging aid	steel strap	
351030	Height Adjusting Unit CB, SCS	
amount	100	
load carrier	wire crate k	
packaging method	loose	
packaging aid	steel strap, wooden cover plate	
351040	Rack CB 240	
amount	77	
load carrier	post pallet RP 120	
packaging method	11 wide, 7 up	
packaging aid	steel strap	
351050	Post Extension CB 180	
amount	30	
load carrier	post pallet RP 150	
packaging method	5 wide, 6 up	
packaging aid	steel strap	

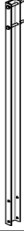
Article No.	Article Name	Article Image
351060	Strongback CB 270	
amount	20	
load carrier	bundle	
packaging method	5 wide, 4 up	
packaging aid	steel strap, dunnage	
351080	Strongback Connector-2, galv.	
amount	500	
load carrier	wire crate k	
packaging method	loose	
packaging aid	steel strap, wooden cover plate	
351090	Connector TRIO-CB	
amount	24	
load carrier	wire crate k	
packaging method	loose	
packaging aid	steel strap, wooden cover plate	
351100	Climbing Bracket CB 160	
amount	1	
load carrier	loose	
packaging method	stacked	
packaging aid		
351110	Adjustable Brace CB 164-224	
amount	28	
load carrier	post pallet RP 120	
packaging method	7 wide, 4 up	
packaging aid	steel strap, square timber	
351120	Platform Connection CB 160	
amount	240	
load carrier	wire crate k	
packaging method	stacked	
packaging aid	steel strap, wooden cover plate	
351130	Adjusting Unit CB 160	
amount	66	
load carrier	wire crate k	
packaging method	loose	
packaging aid	steel strap, wooden cover plate	

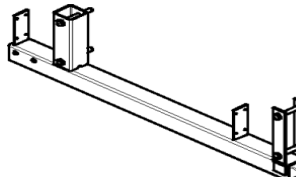
Article No.	Article Name	Article Image
351150	Strongback CB 380	
amount	20	
load carrier	bundle	
packaging method	5 wide, 4 up	
packaging aid	steel strap, dunnage	
351160	Guardrail Connector CB	
amount	500	
load carrier	hardware box	
packaging method	loose	
packaging aid	steel strap, wooden cover plate	
351190	Handrail Post CB 200	
amount	32	
load carrier	post pallet RP 150	
packaging method	4 wide, 8 up	
packaging aid	steel strap	
351200	Platform Post CB 225	
amount	24	
load carrier	post pallet RP 150	
packaging method	8 wide, 3 up	
packaging aid	steel strap	
351210	Handrail Post CB 190	
amount	70	
load carrier	post pallet RP 150	
packaging method	14 wide, 5 up	
packaging aid	steel strap	
351220	Handrail Post CB 370	
amount	42	
load carrier	post pallet RP 150	
packaging method	14 wide, 3 up	
packaging aid	steel strap	
351230	Finishing Platform Beam CB	
amount	24	
load carrier	bundle	
packaging method	12 wide, 2 up	
packaging aid	steel strap, dunnage	

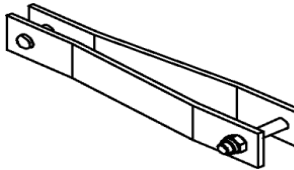
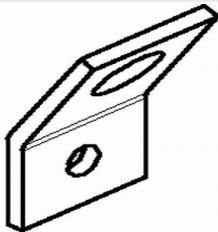
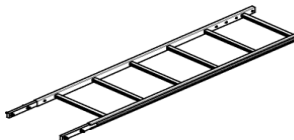
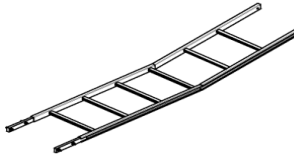
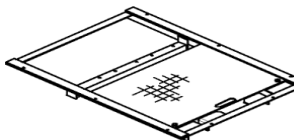
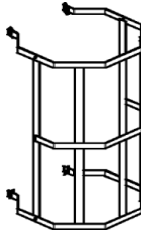
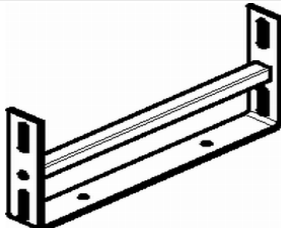
Article No.	Article Name	Article Image
351260	Tension Belt Connector CB	
amount	200	
load carrier	hardware box	
packaging method	stacked	
packaging aid	steel strap, wooden cover plate	
351270	Tension Belt Connector Wall M24	
amount	400	
load carrier	hardware box	
packaging method	stacked	
packaging aid	steel strap, wooden cover plate	
351410	Ladder 180/6, galv.	
amount	18	
load carrier	post pallet RP 150	
packaging method	13 up + 5	
packaging aid	steel strap	
351420	Ladder 220/6	
amount	16	
load carrier	post pallet RP 120	
packaging method	stacked	
packaging aid	steel strap	
351430	Sliding Hatch Cover	
amount	6	
load carrier	post pallet RP 150	
packaging method	stacked	
packaging aid	steel strap, wooden strip between each layer	
351450	Ladder Safety Cage 150, galv.	
amount	5	
load carrier	post pallet RP 150	
packaging method	stacked into each other	
packaging aid	steel strap	
351460	Ladder Base, galv.	
amount	50	
load carrier	hardware box	
packaging method	loose	
packaging aid	steel strap, wooden cover plate	

Article No.	Article Name	Article Image
351610	Side Guardrail Post CB	
amount	26	
load carrier	post pallet RP 120	
packaging method	13 wide, 2 up	
packaging aid	steel strap	
351630	Intermediate Handrail Post CB	
amount	18	
load carrier	post pallet RP 120	
packaging method	6 wide, 3 up	
packaging aid	steel strap	
400541	Connector for Platform VARIO	
amount	200	
load carrier	hardware box	
packaging method	loose	
packaging aid	steel strap, wooden cover plate	
400813	Platform Guardrail 80	
amount	35	
load carrier	wire crate k	
packaging method	stacked	
packaging aid	steel strap, wooden cover plate	
401079	Guardrail Extension ASZ	
amount	15	
load carrier	post pallet RP 120	
packaging method	crosswise stacked	
packaging aid	steel strap	
401269	Platform Strut VARIO 246	
amount	72	
load carrier	post pallet RP 150	
packaging method	12 wide, 6 up	
packaging aid	steel strap, square timber	
401273	Platform Strut VARIO 167	
amount	72	
load carrier	post pallet RP 150	
packaging method	12 wide, 6 up	
packaging aid	steel strap, square timber	

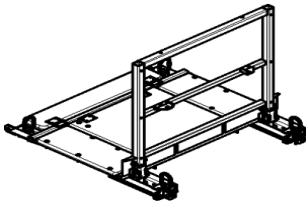
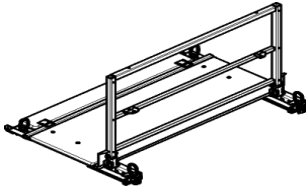
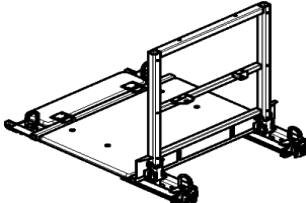
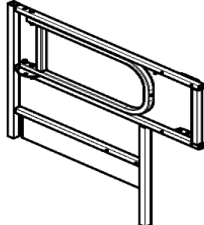
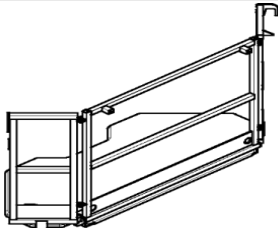
Article No.	Article Name	Article Image
401985	Platform VARIO 100/250 left	
amount	1	
load carrier	loose	
packaging method	stacked	
packaging aid		
402107	Platform VARIO 100/250 right	
amount	1	
load carrier	loose	
packaging method	stacked	
packaging aid		
402415	Platform VARIO 100 x 125 with Hatch	
amount	1	
load carrier	loose	
packaging method	stacked	
packaging aid		
402920	Platform VARIO 100 x 187.5	
amount	1	
load carrier	loose	
packaging method	stacked	
packaging aid		
403203	Platform VARIO 100 x 100	
amount	1	
load carrier	loose	
packaging method	stacked	
packaging aid		
403865	Guardrail for End Platform VARIO	
amount	10	
load carrier	post pallet RP 150	
packaging method	stacked	
packaging aid	steel strap	
403992	External Corner Platform VARIO	
amount	15	
load carrier	bundle	
packaging method	stacked	
packaging aid	steel strap, dunnage	

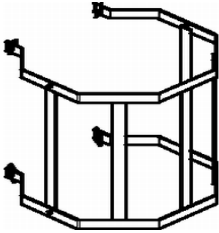
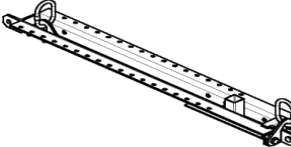
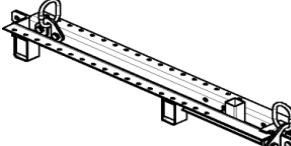
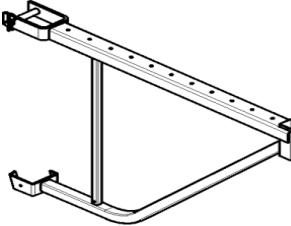
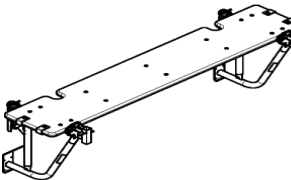
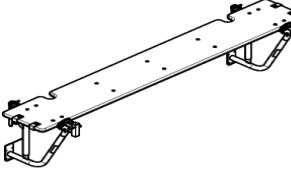
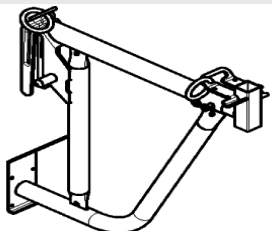

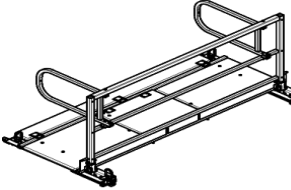
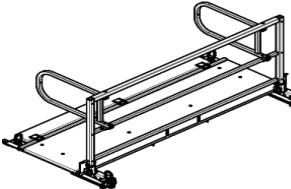
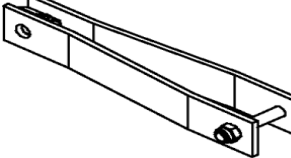
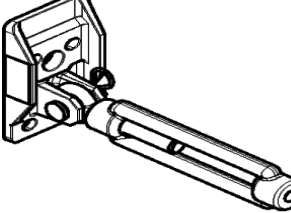
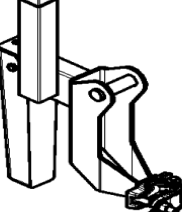
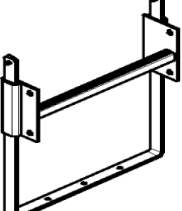
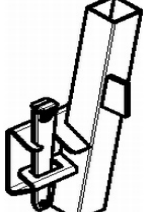
Article No.	Article Name	Article Image
404132	Ladder Safety Cage 75, galv.	
amount	4	
load carrier	wire crate k	
packaging method	stacked into each other	
packaging aid	steel strap, wooden cover plate	
405480	Platform Beam VARIO, left	
amount	20	
load carrier	post pallet RP 120	
packaging method	4 wide, 5 up	
packaging aid	steel strap, square timber	
405484	Platform Beam VARIO, right	
amount	20	
load carrier	post pallet RP 120	
packaging method	4 wide, 5 up	
packaging aid	steel strap, square timber	
405823	Platform Bracket VARIO VBK 90	
amount	16	
load carrier	wire crate k	
packaging method	stacked offset	
packaging aid	steel strap, wooden cover plate	
405843	Platform ASG 70-100 x 240	
amount	6	
load carrier	post pallet RP 120	
packaging method	stacked	
packaging aid	steel strap	
405844	Platform ASG 70-100 x 298	
amount	6	
load carrier	post pallet RP 120	
packaging method	stacked	
packaging aid	steel strap	
405845	Bracket ASG 70-100	
amount	20	
load carrier	wire crate k	
packaging method	2 wide, 10 up	
packaging aid	steel strap, wooden cover plate	

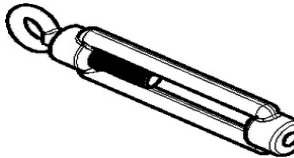
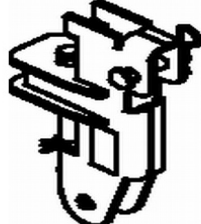
Article No.	Article Name	Article Image
405985	Platform VARIO 100 x 250 with Hatch	
amount	1	
load carrier	loose	
packaging method	stacked	
packaging aid		
405986	Platform VARIO 100 x 250 without Hatch	
amount	1	
load carrier	loose	
packaging method	stacked	
packaging aid		
407007	Tension Anchor Connector CB	
amount	200	
load carrier	wire crate k	
packaging method	stacked	
packaging aid	steel strap, wooden cover plate	
407008	Wall Tension Anchor	
amount	100	
load carrier	hardware box	
packaging method	stacked	
packaging aid	steel strap, wooden plate between each layer, wooden cover plate	
408870	Cavity Wall Bracket ASG	
amount	48	
load carrier	wire crate k	
packaging method	2 layers, 3 x 8 per layer	
packaging aid	steel strap, wooden cover plate	
409105	Ladder Base 30 adjustable, galv.	
amount	50	
load carrier	hardware box	
packaging method	loose	
packaging aid	steel strap, wooden cover plate	
412159	Handrail Post Holder VARIO	
amount	175	
load carrier	wire crate k	
packaging method	7 layers, 25 per layer	
packaging aid	steel strap, wooden cover plate	

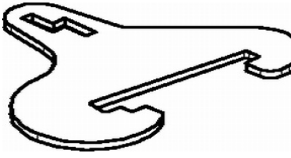

Article No.	Article Name	Article Image
413810	Push-Pull Prop Bolt FB	
amount	500	
load carrier	hardware box	
packaging method	loose	
packaging aid	steel strap, wooden cover plate	
416752	Wall Bracing Shoe CB M24	
amount	155	
load carrier	wire crate k	
packaging method	loose	
packaging aid	steel strap, wooden plate between each layer, wooden cover plate	
416807	Turnbuckle CB M20/DW 15	
amount	200	
load carrier	hardware box	
packaging method	loose	
packaging aid	steel strap, wooden cover plate	
426399	Handrail Post Extension CB	
amount	170	
load carrier	wire crate k	
packaging method	loose	
packaging aid	steel strap, wooden cover plate	
427633	Formwork Waler 150 CB	
amount	15	
load carrier	post pallet RP 120	
packaging method	5 wide, 3 up	
packaging aid	steel strap	
427641	Braket Waler CB 240	
amount	12	
load carrier	post pallet RP 150	
packaging method	6 wide, 2 up	
packaging aid	steel strap	
427650	Brace Connector CB	
amount	200	
load carrier	wire crate k	
packaging method	loose	
packaging aid	steel strap, wooden cover plate	

Article No.	Article Name	Article Image
427654	Pin Adapter MX/TR-SRU	
amount	200	
load carrier	wire crate k	
packaging method	stacked	
packaging aid	steel strap, wooden cover plate	
427659	Clamp Adapter MX/TR-SRU	
amount	200	
load carrier	wire crate k	
packaging method	stacked	
packaging aid	steel strap, wooden cover plate	

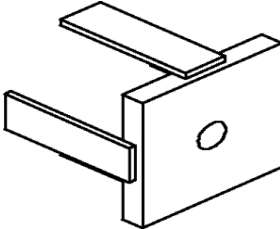
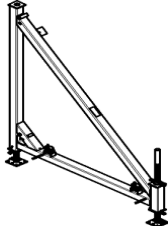
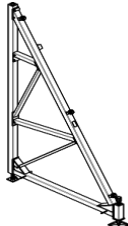
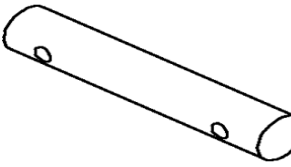
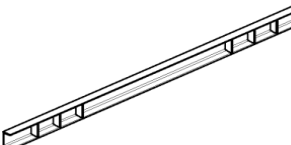
Article No.	Article Name	Article Image
325690	Brace Frame SB-A0	
amount	1	
load carrier	loose	
packaging method	loose	
packaging aid	tied with steel strap during transportation	
325700	Brace Frame SB-A	
amount	1	
load carrier	loose	
packaging method	loose	
packaging aid	tied with steel strap during transportation	
325710	Brace Frame SB-B	
amount	1	
load carrier	loose	
packaging method	loose	
packaging aid	tied with steel strap during transportation	
325720	Brace Frame SB-C	
amount	10	
load carrier	euro pallet	
packaging method	2 wide, 5 up	
packaging aid	steel strap, wooden strip between each layer	
325730	Spindle TR 60x9 / 43	
amount	20	
load carrier	wire crate k	
packaging method	upright	
packaging aid	steel strap, wooden cover plate	
325740	Connector SB-A, B, C - MX/TR/D	
amount	100	
load carrier	wire crate k	
packaging method	loose	
packaging aid	steel strap, wooden cover plate	
325750	Guide Roller SB-A, B	
amount	24	
load carrier	wire crate k	
packaging method	8 wide, 3 up	
packaging aid	steel strap, wooden cover plate	

Article No.	Article Name	Article Image
325760	Waler Connector SB-A, B, C	
amount	500	
load carrier	hardware box	
packaging method	loose	
packaging aid	steel strap, wooden cover plate	
327230	Tension Rod with Nut 135/M30	
amount	100	
load carrier	post pallet RP 120	
packaging method	stacked	
packaging aid	steel strap	
327480	Anchor Plate SB - DW 26	
amount	100	
load carrier	wire crate k	
packaging method	loose	
packaging aid	steel strap, wooden cover plate	
327500	Brace Frame SB-1	
amount	1	
load carrier	loose	
packaging method	loose	
packaging aid	tied with steel strap during transportation	
327510	Brace Frame SB-2	
amount	1	
load carrier	loose	
packaging method	loose	
packaging aid	tied with steel strap during transportation	
327520	Double Anchor Tie Yoke DSW	
amount	160	
load carrier	hardware box	
packaging method	stacked	
packaging aid	steel strap, wooden cover plate	
327530	Anchor Waler U140, l = 2.35 m	
amount	33	
load carrier	post pallet RP 150	
packaging method	11 wide, 3 up	
packaging aid	steel strap	

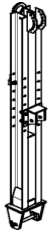
Article No.	Article Name	Article Image
327540	Tension Rod with Nut 100/M30	
amount	100	
load carrier	wire crate k	
packaging method	stacked	
packaging aid	steel strap, wooden cover plate	
327590	Hook Strap for SB-1, 2	
amount	500	
load carrier	wire crate k	
packaging method	loose	
packaging aid	steel strap, wooden cover plate	
327650	Anchor Waler U140, l = 0.55 m	
amount	100	
load carrier	wire crate k	
packaging method	loose	
packaging aid	steel strap, wooden cover plate	
327680	Connector SB-1, 2 - MX/TR/D	
amount	20	
load carrier	euro pallet	
packaging method	5 wide, 4 up	
packaging aid	steel strap, square timber	
327690	Bolt SB-TRIO/DOMINO, galv.	
amount	300	
load carrier	hardware box	
packaging method	10 bags, 30 per bag	
packaging aid	steel strap, wooden cover plate	
329130	Scaffold Bracket SKS 180	
amount	1	
load carrier	loose	
packaging method	stacked	
packaging aid	tied with steel strap during transportation	
329140	Scaffold Bracket SKSF 240	
amount	1	
load carrier	loose	
packaging method	loose	
packaging aid	tied with steel strap during transportation	

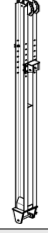
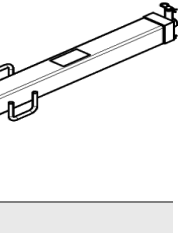
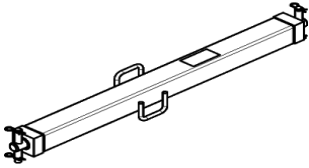
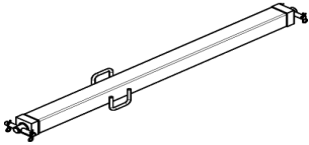
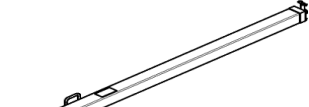
Article No.	Article Name	Article Image
329150	V-Strongback 12-2	
amount	20	
load carrier	bundle	
packaging method	5 wide, 4 up	
packaging aid	steel strap, dunnage	
329160	V-Strongback 12-3	
amount	20	
load carrier	bundle	
packaging method	5 wide, 4 up	
packaging aid	steel strap, dunnage	
329170	V-Strongback 14-3	
amount	20	
load carrier	bundle	
packaging method	5 wide, 4 up	
packaging aid	steel strap, dunnage	
329180	V-Strongback 14-4	
amount	20	
load carrier	bundle	
packaging method	5 wide, 4 up	
packaging aid	steel strap, dunnage	
329200	Compression Brace SKS 2 l = 1,35-1,95 m	
amount	24	
load carrier	post pallet RP 120	
packaging method	6 wide, 4 up	
packaging aid	steel strap, wooden strip between each layer	
329210	Compression Brace SKS 3 l = 1,75-2,35 m	
amount	24	
load carrier	post pallet RP 150	
packaging method	6 wide, 4 up	
packaging aid	steel strap, wooden strip between each layer	
329220	Compression Brace SKS 4 l = 2,55-3,15 m	
amount	24	
load carrier	post pallet RP 150	
packaging method	6 wide, 4 up	
packaging aid	steel strap, wooden strip between each layer	

Article No.	Article Name	Article Image
329280	Anchor Positioning Plate M24, galv.	
amount	2000	
load carrier	hardware box	
packaging method	40 bags, 50 per bag	
packaging aid	steel strap, wooden cover plate	
329310	Scaffold Bracket SKS 90	
amount	30	
load carrier	bundle	
packaging method	stacked	
packaging aid	steel strap, dunnage	
329320	H-Kicker SKS	
amount	15	
load carrier	post pallet RP 120	
packaging method	5 wide, 3 up	
packaging aid	steel strap	
329380	Anchor Positioning Plate M30, galv.	
amount	2000	
load carrier	hardware box	
packaging method	40 bags, 50 per bag	
packaging aid	steel strap, wooden cover plate	
329470	Scaffold Mounting Ring M24, galv.	
amount	500	
load carrier	hardware box	
packaging method	loose	
packaging aid	steel strap, wooden cover plate	
329480	Scaffold Mounting Ring M30, galv.	
amount	500	
load carrier	hardware box	
packaging method	loose	
packaging aid	steel strap, wooden cover plate	
329490	Scaffold Mounting Ring M36, galv.	
amount	500	
load carrier	hardware box	
packaging method	loose	
packaging aid	steel strap, wooden cover plate	

Article No.	Article Name	Article Image
400901	SB-L Tension Strut, l = 740 mm	
amount	75	
load carrier	hardware box	
packaging method	stacked	
packaging aid	steel strap, wooden cover plate	
401621	Tension Release Plate SB DW 26	
amount	80	
load carrier	wire crate k	
packaging method	stacked	
packaging aid	steel strap, wooden cover plate	
402390	Drill- and Pretension Device 45°	
amount	1	
load carrier	loose	
packaging method	loose	
packaging aid		
404754	Finishing Platform Waler SKS	
amount	28	
load carrier	post pallet RP 120	
packaging method	7 wide, 4 up	
packaging aid	steel strap	
404755	Guardrail Post SKS	
amount	104	
load carrier	post pallet RP 120	
packaging method	stacked	
packaging aid	steel strap, square timber	
404756	Finishing Platform Post SKS 3	
amount	36	
load carrier	post pallet RP 120	
packaging method	12 wide, 3 up	
packaging aid	steel strap	
404757	Finishing Platform Post SKS 4	
amount	36	
load carrier	post pallet RP 150	
packaging method	12 wide, 3 up	
packaging aid	steel strap	

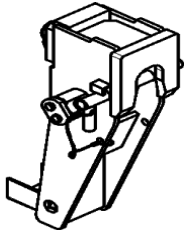
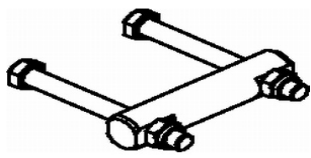
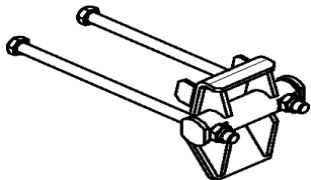
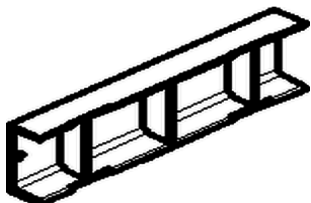
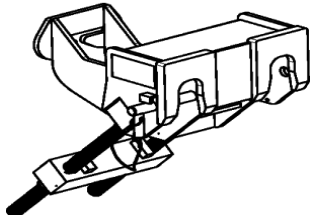
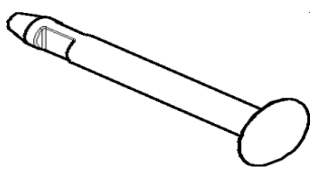
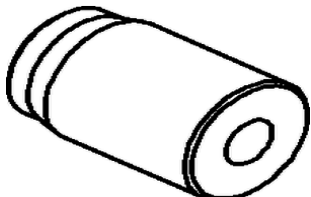
Article No.	Article Name	Article Image
406661	Brace Frame Wall Scaffold Hinge	
amount	30	
load carrier	wire crate k	
packaging method	stacked	
packaging aid	steel strap, wooden cover plate	
406662	Brace Frame Adaptor SB A0, A, B	
amount	100	
load carrier	hardware box	
packaging method	loose	
packaging aid	steel strap, wooden cover plate	
406663	Brace Frame Adaptor SB-2	
amount	20	
load carrier	hardware box	
packaging method	loose	
packaging aid	steel strap, wooden cover plate	
409017	Anchor Waler U160, l = 0.55 m	
amount	100	
load carrier	wire crate k	
packaging method	stacked	
packaging aid	steel strap, wooden cover plate	
411866	Wall Scaffold Hinge SB double	
amount	4	
load carrier	wire crate k	
packaging method	stacked	
packaging aid	steel strap, wooden cover plate	
413255	Bolt SB-MAXIMO, galv.	
amount	1000	
load carrier	hardware box	
packaging method	loose	
packaging aid	steel strap, wooden cover plate	
414107	Sleeve SB-MAXIMO, galv.	
amount	1000	
load carrier	hardware box	
packaging method	loose	
packaging aid	steel strap, wooden cover plate	



Article No.	Article Name	Article Image
414417	Sleeve SB-MAXIMO WDMX	
amount	1000	
load carrier	hardware box	
packaging method	loose	
packaging aid	steel strap, wooden cover plate	
418578	Platform Post SCS 232	
amount	60	
load carrier	post pallet RP 150	
packaging method	12 wide, 5 up	
packaging aid	steel strap	
418579	Guardrail Post SCS 150	
amount	104	
load carrier	post pallet RP 120	
packaging method	stacked	
packaging aid	steel strap, square timber	
418580	Spindle Connector SCS Ø 26-21	
amount	192	
load carrier	wire crate k	
packaging method	4 rows, 8 per row, 6 up	
packaging aid	steel strap, wooden cover plate	
418582	Mounting Ring SCS M30	
amount	250	
load carrier	hardware box	
packaging method	loose	
packaging aid	steel strap, wooden cover plate	
418583	Platform Beam SCS 112	
amount	33	
load carrier	wire crate k	
packaging method	11 wide, 3 up	
packaging aid	steel strap, wooden cover plate	
418584	Strongback SCS 325	
amount	20	
load carrier	bundle	
packaging method	5 wide, 4 up	
packaging aid	steel strap, square timber, dunnage	

Article No.	Article Name	Article Image
418585	Heavy Duty Spindle SCS 198-250	
amount	28	
load carrier	post pallet RP 150	
packaging method	7 wide, 4 up	
packaging aid	steel strap	
418710	Vertical Strut SCS 237	
amount	12	
load carrier	post pallet RP 150	
packaging method	stacked	
packaging aid	steel strap	
418714	Diagonal Strut SCS 257	
amount	24	
load carrier	post pallet RP 150	
packaging method	stacked	
packaging aid	steel strap	
418730	Crossbeam Unit SCS 190	
amount	4	
load carrier	post pallet RP 120	
packaging method	stacked	
packaging aid	steel strap	
418737	Crossbeam Unit SCS 250	
amount	4	
load carrier	post pallet USP 104	
packaging method	stacked	
packaging aid	steel strap	
418772	Mounting Ring SCS M36	
amount	250	
load carrier	hardware box	
packaging method	loose	
packaging aid	steel strap, wooden cover plate	
418799	STARTER BAR SCS	
amount	7	
load carrier	post pallet RP 120	
packaging method	3 wide, 2 up + 1 in the middle	
packaging aid	steel strap, square timber	

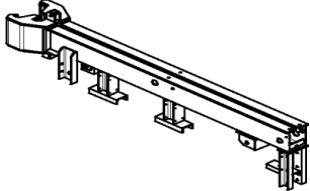
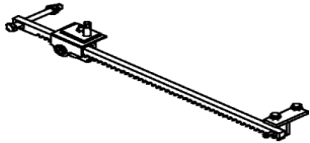
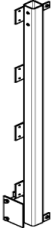
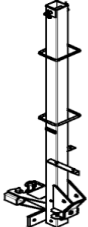
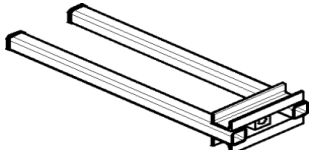
Article No.	Article Name	Article Image
423664	Connection Plate SCS Ø 21-125	
amount	100	
load carrier	hardware box	
packaging method	loose	
packaging aid	steel strap, wooden cover plate	
426088	Guardrail Post Holder MULTI	
amount	78	
load carrier	wire crate k	
packaging method	39 wide, 2 up	
packaging aid	steel strap, wooden cover plate	
427099	Adapter Adjusting Unit SCS/RCS	
amount	20	
load carrier	hardware box	
packaging method	stacked	
packaging aid	steel strap, wooden cover plate	
429674	Strongback SCS 550	
amount	10	
load carrier	bundle	
packaging method	5 wide, 2 up	
packaging aid	steel strap, square timber	

Article No.	Article Name	Article Image
351701	Main Platform Beam ACS /Car.+ M-Dr.	
amount	3	
load carrier	post pallet RP 150	
packaging method	stacked	
packaging aid	steel strap	
351703	Main Platform Beam ACS/Carriage	
amount	3	
load carrier	post pallet RP 150	
packaging method	stacked	
packaging aid	steel strap	
		
351704	Carriage ACS, compl.	
amount	15	
load carrier	post pallet RP 120	
packaging method	5 wide, 3 up	
packaging aid	steel strap, square timber	
		
351705	Mechanical Drive ACS, A-M	
amount	50	
load carrier	wire crate k	
packaging method	stacked	
packaging aid	steel strap, wooden cover plate	
		
351707	Guardrail Post Main Platform ACS	
amount	16	
load carrier	post pallet RP 150	
packaging method	stacked	
packaging aid	steel strap, square timber	
		
351710	Vertical Strut ACS	
amount	4	
load carrier	post pallet RP 150	
packaging method	stacked	
packaging aid	steel strap, square timber	
		
351711	Sliding Unit ACS-R	
amount	25	
load carrier	wire crate k	
packaging method	stacked	
packaging aid	steel strap, wooden cover plate	
		

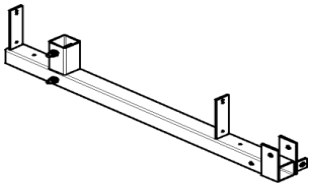
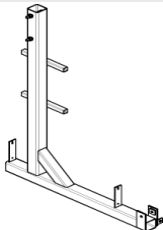
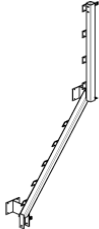

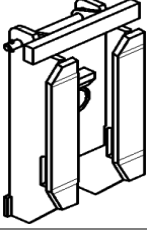
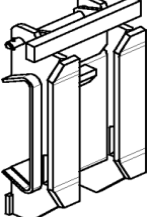
Article No.	Article Name	Article Image
351712	Compression Spindle ACS, compl.	
amount	150	
load carrier	hardware box	
packaging method	loose	
packaging aid	steel strap, wooden cover plate	
351714	Compression Strut ACS	
amount	24	
load carrier	post pallet RP 150	
packaging method	6 wide, 4 up	
packaging aid	steel strap, wooden strip between each layer	
351715	Guardrail Post KB ACS I = 2.83 m	
amount	32	
load carrier	post pallet RP 150	
packaging method	8 wide, 4 up	
packaging aid	steel strap, wooden strip between each layer	
351716	Main Cantilever Beam ACS	
amount	12	
load carrier	post pallet RP 120	
packaging method	stacked	
packaging aid	steel strap	
351717	Platform Post 500 ACS	
amount	21	
load carrier	post pallet RP 150	
packaging method	7 wide, 3 up	
packaging aid	steel strap	
351718	Guardrail Post FP ACS I = 2.51 m	
amount	40	
load carrier	post pallet RP 150	
packaging method	8 wide, 5 up	
packaging aid	steel strap, wooden strip between each layer	
351719	Guardrail Post FP ACS I = 3.98 m	
amount	32	
load carrier	post pallet RP 150	
packaging method	8 wide, 4 up	
packaging aid	steel strap, square timber	

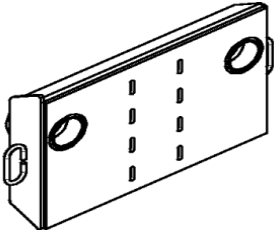
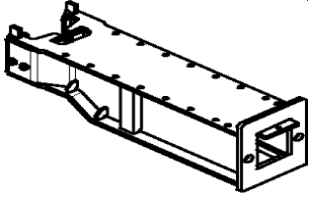

Article No.	Article Name	Article Image
351720	Lower Cantilever Beam ACS	
amount	23	
load carrier	post pallet RP 120	
packaging method	stacked	
packaging aid	steel strap	
351721	Lower Cantilever Beam 360 ACS	
amount	4	
load carrier	post pallet RP 150	
packaging method	stacked	
packaging aid	steel strap, wooden strip between each layer	
351722	Cantilever Post CP ACS	
amount	24	
load carrier	bundle	
packaging method	stacked	
packaging aid	steel strap, square timber, dunnage	
351723	Cantilever Post FP ACS I = 2.61 m	
amount	15	
load carrier	post pallet RP 150	
packaging method	5 wide, 3 up	
packaging aid	steel strap, square timber	
351724	Cantilever Post FP ACS, long	
amount	8	
load carrier	bundle	
packaging method	stacked	
packaging aid	steel strap, square timber, dunnage	
351725	Climbing Shoe I ACS	
amount	20	
load carrier	wire crate k	
packaging method	4 wide, 5 up	
packaging aid	steel strap, wooden cover plate	
351726	Climbing Shoe II ACS	
amount	20	
load carrier	wire crate k	
packaging method	4 wide, 5 up	
packaging aid	steel strap, wooden cover plate	

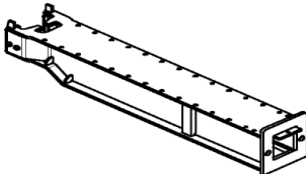
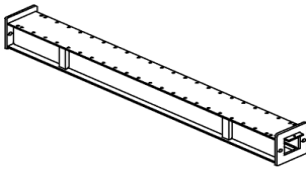
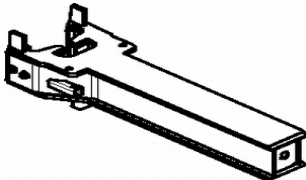
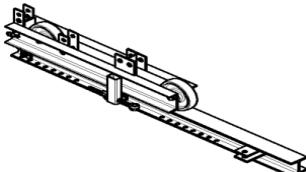
Article No.	Article Name	Article Image
351727	Double Anchor Support, right	
amount	30	
load carrier	wire crate k	
packaging method	stacked	
packaging aid	steel strap, wooden cover plate	
351729	Locking Bar ACS	
amount	150	
load carrier	hardware box	
packaging method	loose	
packaging aid	steel strap, wooden cover plate	
351730	Leading Anchor Plate ACS	
amount	200	
load carrier	hardware box	
packaging method	stacked	
packaging aid	steel strap, wooden cover plate	
351731	Climbing Rail 630 ACS	
amount	7	
load carrier	bundle	
packaging method	bundeled	
packaging aid	steel strap, square timber, dunnage	
351735	Tension Plate ACS	
amount	500	
load carrier	wire crate k	
packaging method	loose	
packaging aid	steel strap, wooden cover plate	
351736	Distance Piece cpl.	
amount	150	
load carrier	wire crate k	
packaging method	6 layers, 24 per layer + 6	
packaging aid	steel strap, wooden plate between each layer, wooden cover plate	
351738	Hydraulic Climbing Mechanism ACS 100, cpl.	
amount	12	
load carrier	wooden box	
packaging method	stacked	
packaging aid	steel strap	

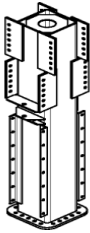
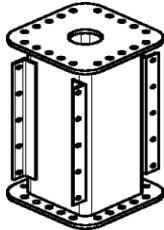
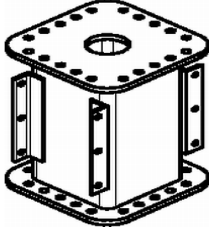
Article No.	Article Name	Article Image
351742	Hydraulic Pump 6-fold 400V/50Hz	
amount	1	
load carrier	wooden box	
packaging method	stacked	
packaging aid	steel strap	
351744	Hydraulic Pump 2x 4-fold 400V/50Hz	
amount	1	
load carrier	wooden box	
packaging method	stacked	
packaging aid	steel strap	
351746	Hydraulic Pump 8-fold 400V/50Hz	
amount	1	
load carrier	wooden box	
packaging method	stacked	
packaging aid	steel strap	
351774	Double Anchor Support, left	
amount	30	
load carrier	wire crate k	
packaging method	stacked	
packaging aid	steel strap, wooden cover plate	
		
357000	Main Platform Beam 1400 single ACS-P	
amount	2	
load carrier	post pallet RP 120	
packaging method	stacked	
packaging aid	steel strap	
		
357001	Main Platform Beam 1550 single ACS-P	
amount	4	
load carrier	post pallet USP 104	
packaging method	2 wide, 2 up	
packaging aid	steel strap	
357003	Main Platform Beam 1850 single ACS-P	
amount	2	
load carrier	post pallet RP 120	
packaging method	stacked	
packaging aid	steel strap	

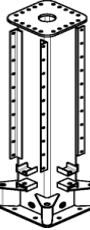
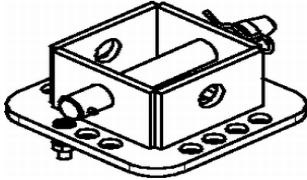
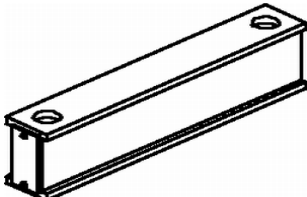
Article No.	Article Name	Article Image
357005	Main Platform Beam 2150 single ACS-P	
amount	2	
load carrier	post pallet RP 120	
packaging method	stacked	
packaging aid	steel strap	
357006	Main Platform Beam 2300 single ACS-P	
amount	2	
load carrier	post pallet RP 120	
packaging method	stacked	
packaging aid	steel strap	
357009	Main Platform Beam 2600 double ACS-P	
amount	2	
load carrier	post pallet USP 104	
packaging method	stacked	
packaging aid	steel strap	
357010	Main Platform Beam 2900 double ACS-P	
amount	4	
load carrier	bundle	
packaging method	2 wide, 2 up	
packaging aid	steel strap, square timber, dunnage	
357012	Main Platform Beam 3500 double ACS-P	
amount	2	
load carrier	post pallet RP 120	
packaging method	stacked	
packaging aid	steel strap	
357013	Main Platform Beam Head Piece ACS-P	
amount	4	
load carrier	post pallet RP 120	
packaging method	stacked	
packaging aid	steel strap	
357015	Carriage ACS-P	
amount	6	
load carrier	post pallet RP 120	
packaging method	stacked	
packaging aid	steel strap, wooden strip between each layer	

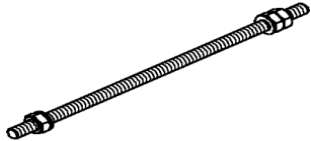
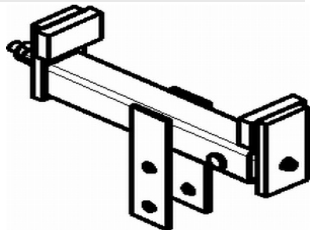
Article No.	Article Name	Article Image
357016	Vertical Post Top 2100 ACS	
amount	2	
load carrier	post pallet RP 120	
packaging method	stacked	
packaging aid	steel strap	
357017	Vertical Post Intermediate 900 ACS	
amount	6	
load carrier	bundle	
packaging method	stacked	
packaging aid	steel strap, square timber, dunnage	
357018	Vertical Post Intermediate 600 ACS	
amount	6	
load carrier	wire crate k	
packaging method	stacked	
packaging aid	steel strap, wooden cover plate	
357019	Vertical Post Intermediate 300 ACS	
amount	8	
load carrier	wire crate k	
packaging method	stacked	
packaging aid	steel strap, wooden cover plate	
357020	Vertical Post Base 2075 ACS	
amount	1	
load carrier	post pallet RP 150	
packaging method	loose	
packaging aid	steel strap	
357022	Vertical Post Connector ACS-P	
amount	24	
load carrier	wire crate k	
packaging method	4 layers, 6 per layer	
packaging aid	steel strap, wooden cover plate	
357025	Yoke 430 ACS-P	
amount	70	
load carrier	wire crate k	
packaging method	stacked	
packaging aid	steel strap, wooden cover plate	

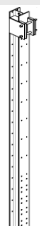
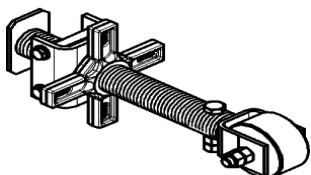
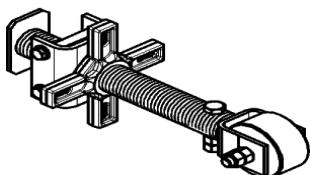
Article No.	Article Name	Article Image
357026	Clamping Bolt M36 x 1000 ACS-P	
amount	100	
load carrier	wire crate k	
packaging method	stacked	
packaging aid	steel strap, wooden cover plate	
357027	Post Connector ACS-P	
amount	100	
load carrier	hardware box	
packaging method	loose	
packaging aid	steel strap, wooden cover plate	
357029	FP Post 2995 ACS	
amount	40	
load carrier	post pallet RP 150	
packaging method	stacked	
packaging aid	steel strap	
357030	Post Extension 2955 ACS	
amount	80	
load carrier	post pallet RP 150	
packaging method	stacked	
packaging aid	steel strap	
357032	Platform Post 5900 HEA 240 ACS	
amount	6	
load carrier	bundle	
packaging method	stacked	
packaging aid	steel strap, square timber, dunnage	
357033	Cantilever Platform Beam 570-870 ACS	
amount	8	
load carrier	wire crate k	
packaging method	stacked	
packaging aid	steel strap, wooden cover plate	
357034	Supporting Spindle ACS	
amount	200	
load carrier	wire crate k	
packaging method	loose	
packaging aid	steel strap, wooden cover plate	

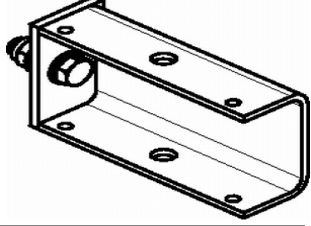
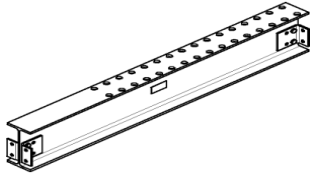

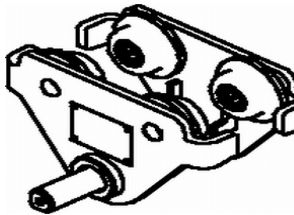
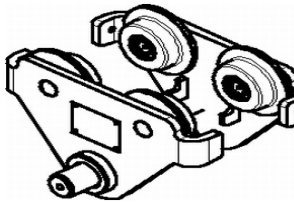
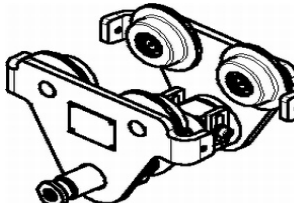
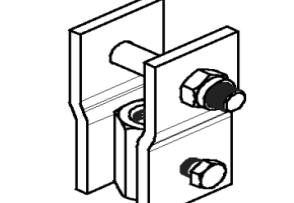
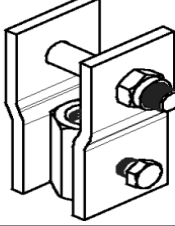
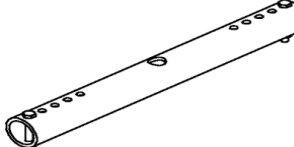
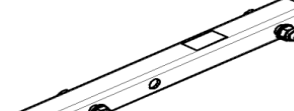
Article No.	Article Name	Article Image
357036	Guardrail Post 1485 ACS	
amount	65	
load carrier	post pallet RP 120	
packaging method	stacked	
packaging aid	steel strap	
357037	Clamp VT 20 ACS	
amount	200	
load carrier	hardware box	
packaging method	loose	
packaging aid	steel strap, wooden cover plate	
357038	Clamp GT24 ACS	
amount	200	
load carrier	hardware box	
packaging method	loose	
packaging aid	steel strap, wooden cover plate	
357039	Railing Adaptor VT20 ACS	
amount	400	
load carrier	wire crate k	
packaging method	stacked	
packaging aid	steel strap, wooden cover plate	
357040	Panel Carrier Beam 1110 ACS	
amount	16	
load carrier	wire crate k	
packaging method	stacked	
packaging aid	steel strap, wooden cover plate	
357041	Trolley HTP 500 kg, Size: A	
amount	80	
load carrier	wire crate k	
packaging method	stacked	
packaging aid	steel strap, wooden cover plate	
357042	Trolley HTP 500 kg, Size: B	
amount	80	
load carrier	wire crate k	
packaging method	stacked	
packaging aid	steel strap, wooden cover plate	

Article No.	Article Name	Article Image
357043	Trolley HTP 1000 kg, Size: A	
amount	80	
load carrier	wire crate k	
packaging method	stacked	
packaging aid	steel strap, wooden cover plate	
357044	Trolley HTP 1000 kg, Size: B	
amount	50	
load carrier	wire crate k	
packaging method	stacked	
packaging aid	steel strap, wooden cover plate	
357045	Trolley HTP 2000 kg, Size: A	
amount	50	
load carrier	wire crate k	
packaging method	stacked	
packaging aid	steel strap, wooden cover plate	
357046	Trolley HTP 2000 kg, Size: B	
amount	50	
load carrier	wire crate k	
packaging method	stacked	
packaging aid	steel strap, wooden cover plate	
357049	Panel Suspension Adaptor DW 20 ACS	
amount	200	
load carrier	hardware box	
packaging method	loose	
packaging aid	steel strap, wooden cover plate	
357050	Suspension Tube Vario 53	
amount	135	
load carrier	hardware box	
packaging method	5 layers, 27 per layer	
packaging aid	steel strap, wooden cover plate	
357051	AV Connector ACS	
amount	90	
load carrier	hardware box	
packaging method	stacked	
packaging aid	steel strap, wooden cover plate	

Article No.	Article Name	Article Image
357052	Offset AV Connector ACS	
amount	200	
load carrier	hardware box	
packaging method	loose	
packaging aid	steel strap, wooden cover plate	
357053	Bracket ACS-G	
amount	1	
load carrier	loose	
packaging method	stacked	
packaging aid		
357054	Compression Spindle M42 ACS	
amount	100	
load carrier	hardware box	
packaging method	loose	
packaging aid	steel strap, wooden cover plate	
357055	FP Post 2350 ACS-G	
amount	6	
load carrier	post pallet RP 150	
packaging method	stacked	
packaging aid	steel strap, square timber	
357056	FP Post 3300 ACS-G	
amount	6	
load carrier	post pallet RP 150	
packaging method	stacked	
packaging aid	steel strap, square timber	
357057	FP Beam 1365 ACS-G	
amount	6	
load carrier	post pallet RP 120	
packaging method	stacked	
packaging aid	steel strap, square timber	
357058	Gallow 3325 ACS-G	
amount	3	
load carrier	bundle	
packaging method	stacked	
packaging aid	steel strap, square timber, dunnage	

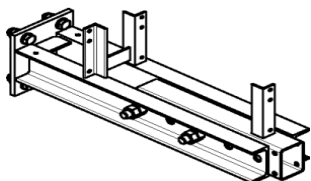
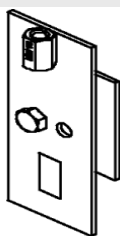
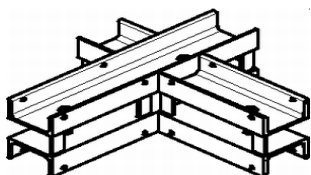
Article No.	Article Name	Article Image
357059	Gallow 1430 ACS-G	
amount	3	
load carrier	post pallet RP 120	
packaging method	stacked	
packaging aid	steel strap, square timber	
357060	Main Platform Beam End Piece ACS-P	
amount	2	
load carrier	post pallet RP 120	
packaging method	stacked	
packaging aid	steel strap, square timber	
357061	Diagonal Strut 1473 ACS-P	
amount	18	
load carrier	post pallet RP 120	
packaging method	3 layers, 6 per layer	
packaging aid	steel strap	
357062	Vertical Strut 1210 ACS-P	
amount	10	
load carrier	post pallet RP 120	
packaging method	stacked	
packaging aid	steel strap	
357063	Beam Adaptor Type 1 ACS	
amount	16	
load carrier	wire crate k	
packaging method	4 wide, 4 up	
packaging aid	steel strap, wooden cover plate	
357065	Post Connector VT20 - GT24 ACS	
amount	40	
load carrier	hardware box	
packaging method	stacked	
packaging aid	steel strap, wooden cover plate	
357067	Vertical Post Intermediate 1200 ACS	
amount	6	
load carrier	bundle	
packaging method	stacked	
packaging aid	steel strap, square timber, dunnage	

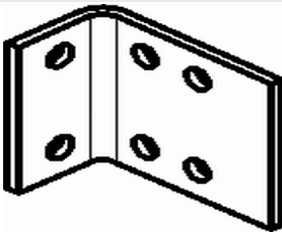
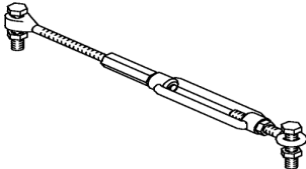
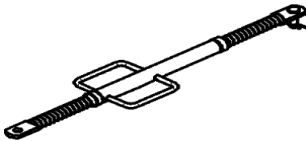
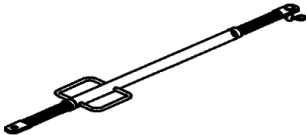
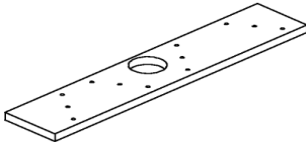

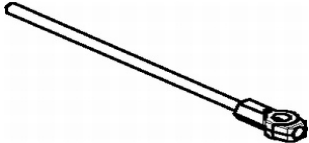
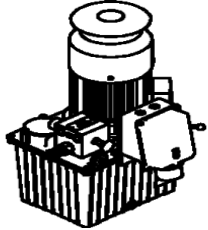
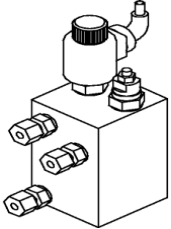
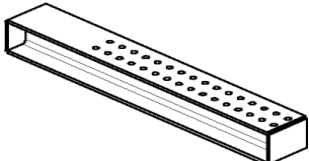

Article No.	Article Name	Article Image
357068	Platform Post 5900 IPBL 200 ACS	
amount	6	
load carrier	bundle	
packaging method	stacked	
packaging aid	steel strap, square timber, dunnage	
357069	Platform Post 5900 IPBL 160 ACS	
amount	6	
load carrier	bundle	
packaging method	stacked	
packaging aid	steel strap, square timber, dunnage	
357070	Platform Post 7100 HEA 240 ACS	
amount	4	
load carrier	bundle	
packaging method	stacked	
packaging aid	steel strap, square timber, dunnage	
357072	Cantilever Platform Beam 870-1170 ACS	
amount	12	
load carrier	wire crate k	
packaging method	stacked	
packaging aid	steel strap, wooden cover plate	
357075	Connector VT20 Bottom ACS	
amount	300	
load carrier	wire crate k	
packaging method	loose	
packaging aid	steel strap, wooden cover plate	
357076	Suspension for Corner Element ACS	
amount	100	
load carrier	hardware box	
packaging method	loose	
packaging aid	steel strap, wooden cover plate	
357077	Steel Corner Waler ESRZ 46/41,6	
amount	30	
load carrier	wire crate k	
packaging method	stacked	
packaging aid	steel strap, wooden cover plate	

Article No.	Article Name	Article Image
357080	Waler Hook Left ACS	
amount	200	
load carrier	hardware box	
packaging method	loose	
packaging aid	steel strap, wooden cover plate	
357082	Trolley Stopper	
amount	1000	
load carrier	hardware box	
packaging method	loose	
packaging aid	steel strap, wooden cover plate	
357083	Bracing DW 15 ACS	
amount	150	
load carrier	hardware box	
packaging method	loose	
packaging aid	steel strap, wooden cover plate	
357087	Kicker AV 82	
amount	200	
load carrier	wire crate k	
packaging method	stacked	
packaging aid	steel strap, square timber	
357088	Kicker AV 111	
amount	200	
load carrier	wire crate k	
packaging method	stacked	
packaging aid	steel strap, wooden cover plate	
357095	Plywood Insert GT 24 ACS	
amount	500	
load carrier	hardware box	
packaging method	loose	
packaging aid	steel strap, wooden cover plate	
357097	Strongback 255 ACS	
amount	9	
load carrier	post pallet RP 150	
packaging method	stacked	
packaging aid	steel strap, wooden strip between each layer	

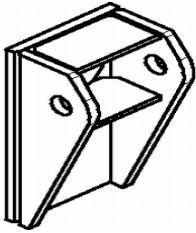
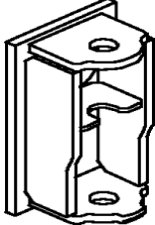
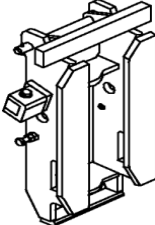
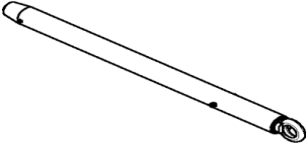

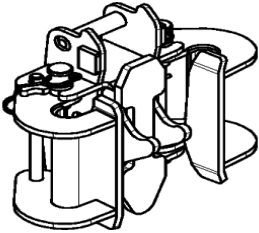
Article No.	Article Name	Article Image
357098	Strongback 365 ACS	
amount	9	
load carrier	post pallet RP 150	
packaging method	stacked	
packaging aid	steel strap	
357213	Climbing Rail 694 ACS	
amount	5	
load carrier	bundle	
packaging method	stacked	
packaging aid	steel strap, square timber, dunnage	
357215	Climbing Rail 822 ACS	
amount	5	
load carrier	bundle	
packaging method	stacked	
packaging aid	steel strap, square timber, dunnage	
357336	Tie Yoke 465 ACS	
amount	300	
load carrier	hardware box	
packaging method	stacked	
packaging aid	steel strap, wooden cover plate	
357357	Hydraulic Pump 1-fold 50Hz/60Hz	
amount	1	
load carrier	wooden box	
packaging method	stacked	
packaging aid	steel strap	
357358	Control Block 3/50Hz	
amount	18	
load carrier	wire crate k	
packaging method	stacked	
packaging aid	steel strap, wooden cover plate	
357389	Panel Carrier Beam 1110 IPB 160 ACS	
amount	12	
load carrier	post pallet RP 120	
packaging method	stacked	
packaging aid	steel strap	

Article No.	Article Name	Article Image
357391	Head Adapter ACS-P	
amount	8	
load carrier	wire crate k	
packaging method	stacked	
packaging aid	steel strap, wooden cover plate	
357395	Connection Beam 2350 ACS-P	
amount	1	
load carrier	post pallet USP 104	
packaging method	loose	
packaging aid	steel strap	
357400	Vertical Strut 3075 ACS-P	
amount	4	
load carrier	post pallet RP 150	
packaging method	stacked	
packaging aid	steel strap	
357402	End Piece 2000 ACS-P	
amount	2	
load carrier	wire crate k	
packaging method	stacked	
packaging aid	steel strap, wooden cover plate	
357427	Compression Brace ACS I = 1,77-2,33 m	
amount	15	
load carrier	post pallet RP 150	
packaging method	stacked	
packaging aid	steel strap	
357430	Compression Brace ACS I = 2,57-3,13 m	
amount	15	
load carrier	post pallet RP 150	
packaging method	stacked	
packaging aid	steel strap	
357517	Winch 1.0 t	
amount	1	
load carrier	loose	
packaging method	loose	
packaging aid		

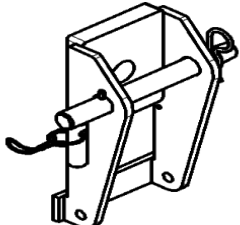
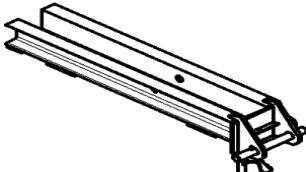
Article No.	Article Name	Article Image
357566	Anchor Shoe-H ACS	
amount	75	
load carrier	wire crate k	
packaging method	stacked	
packaging aid	steel strap, wooden cover plate	
357567	Anchor Shoe-V ACS	
amount	75	
load carrier	wire crate k	
packaging method	stacked	
packaging aid	steel strap, wooden cover plate	
357568	Climbing Shoe IV ACS	
amount	20	
load carrier	wire crate k	
packaging method	4 wide, 5 up	
packaging aid	steel strap, wooden cover plate	
357570	Bolt 35 x 525 ACS	
amount	300	
load carrier	hardware box	
packaging method	loose	
packaging aid	steel strap, wooden cover plate	
357637	Hydraulic Pump 2-fold 50HT/4CCM	
amount	1	
load carrier	wooden box	
packaging method	stacked	
packaging aid	steel strap	
357639	Hydraulic Pump 4-fold 50HT/4CCM	
amount	1	
load carrier	wooden box	
packaging method	stacked	
packaging aid	steel strap	
357641	Hydraulic Pump 6-fold 50HT/4CCM	
amount	1	
load carrier	wooden box	
packaging method	stacked	
packaging aid	steel strap	

Article No.	Article Name	Article Image
409468	Climbing Shoe RCS	
amount	30	
load carrier	wire crate k	
packaging method	loose	
packaging aid	steel strap, wooden cover plate	
409469	Climbing Rail RCS 248	
amount	4	
load carrier	bundle	
packaging method	stacked	
packaging aid	steel strap, square timber, dunnage	
409470	Climbing Rail RCS 348	
amount	4	
load carrier	bundle	
packaging method	stacked	
packaging aid	steel strap, square timber, dunnage	
409471	Climbing Rail RCS 498	
amount	4	
load carrier	bundle	
packaging method	stacked	
packaging aid	steel strap, square timber, dunnage	
409472	Climbing Rail RCS 748	
amount	4	
load carrier	bundle	
packaging method	stacked	
packaging aid	steel strap, square timber, dunnage	
409503	Wall Shoe RCS	
amount	135	
load carrier	wire crate k	
packaging method	loose	
packaging aid	steel strap, wooden cover plate	
409567	Slab Shoe RCS	
amount	28	
load carrier	wire crate k	
packaging method	stacked	
packaging aid	steel strap	

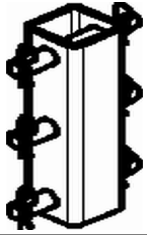
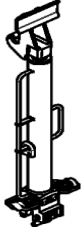
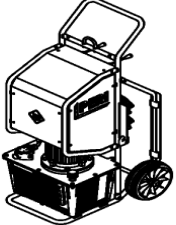
Article No.	Article Name	Article Image
409610	Climbing Rail RCS 998	
amount	5	
load carrier	bundle	
packaging method	stacked	
packaging aid	steel strap, square timber, dunnage	
409716	Crossbeam RCS 220	
amount	3	
load carrier	post pallet RP 150	
packaging method	3 wide, 1 up	
packaging aid	steel strap, square timber	
409717	Intermediate Platform Beam RCS 241	
amount	9	
load carrier	post pallet RP 150	
packaging method	3 wide, 3 up	
packaging aid	steel strap, wooden strip between each layer	
409718	Diagonal Strut RCS 142	
amount	36	
load carrier	post pallet RP 120	
packaging method	6 wide, 6 up	
packaging aid	steel strap, wooden strip between each layer	
409720	Guardrail Post RCS 226	
amount	45	
load carrier	post pallet RP 150	
packaging method	9 wide, 5 up	
packaging aid	steel strap, square timber	
409721	Guardrail Post RCS 384	
amount	30	
load carrier	post pallet RP 150	
packaging method	6 wide, 5 up	
packaging aid	steel strap, square timber	
409722	Finishing Platform Beam RCS 122	
amount	25	
load carrier	post pallet RP 120	
packaging method	5 wide, 5 up	
packaging aid	steel strap, square timber	

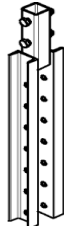
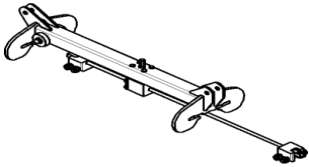
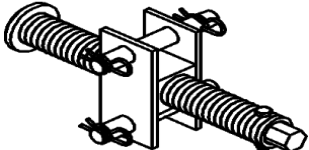

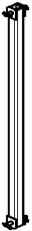
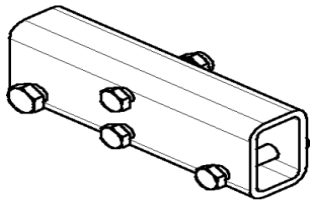
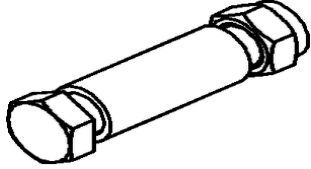
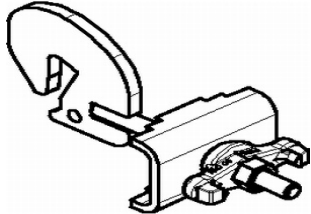
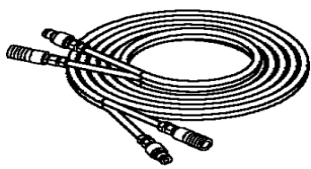
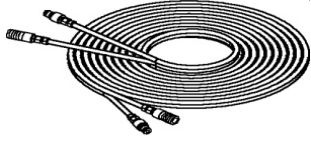
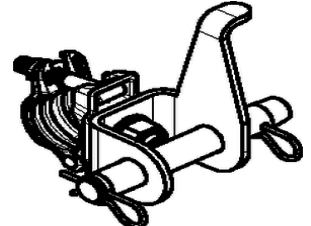
Article No.	Article Name	Article Image
409743	Climbing Rail Connector RCS 33	
amount	100	
load carrier	wire crate k	
packaging method	loose	
packaging aid	steel strap, wooden cover plate	
409765	Climbing Device RCS 50	
amount	4	
load carrier	wooden box	
packaging method	stacked	
packaging aid	steel strap	
409766	Hydraulic Pump RCS 4-fold, 380 – 460V	
amount	2	
load carrier	wooden box	
packaging method	stacked	
packaging aid	steel strap	
409773	Guardrail Post RCS 509	
amount	22	
load carrier	post pallet RP 150	
packaging method	10 wide, 2 up + 2	
packaging aid	steel strap, square timber	
409791	Climbing Rail Extension RCS 100	
amount	30	
load carrier	post pallet RP 120	
packaging method	10 wide, 3 up	
packaging aid	steel strap	
409968	Carriage RCS	
amount	12	
load carrier	post pallet RP 120	
packaging method	4 wide, 3 up	
packaging aid	steel strap, square timber	
410000	Compression Point RCS	
amount	30	
load carrier	hardware box	
packaging method	stacked	
packaging aid	steel strap, wooden cover plate	



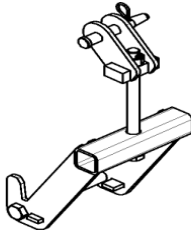
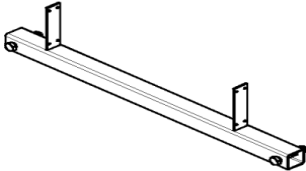
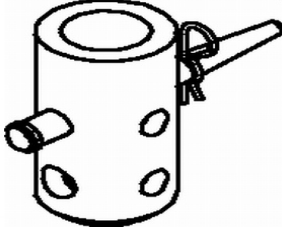
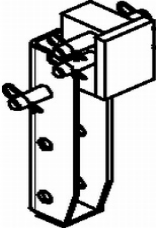
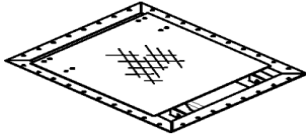
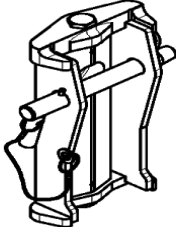
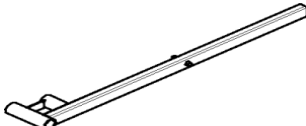

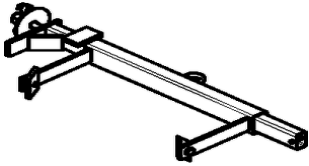
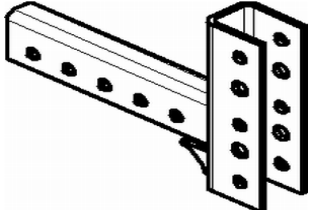
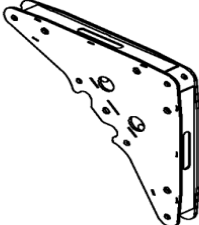
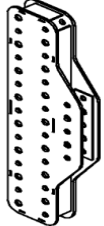
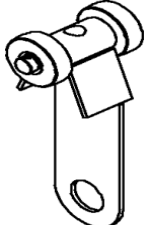
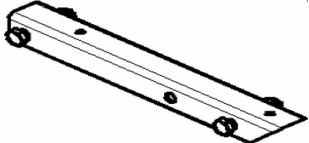
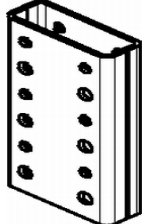
Article No.	Article Name	Article Image
410012	Diagonal Strut RCS 212	
amount	45	
load carrier	post pallet RP 150	
packaging method	9 wide, 5 up	
packaging aid	steel strap, square timber	
410015	Crossbeam Head RCS/VARIO	
amount	120	
load carrier	wire crate k	
packaging method	stacked	
packaging aid	steel strap, wooden cover plate	
410023	Spacer M24-82	
amount	100	
load carrier	hardware box	
packaging method	loose	
packaging aid	steel strap, wooden cover plate	
410059	Waler Fixation U100 – U120	
amount	500	
load carrier	wire crate k	
packaging method	loose	
packaging aid	steel strap, wooden cover plate	
410069	Hydraulic Twin Hose RCS, 10 m	
amount	20	
load carrier	hardware box	
packaging method	stacked	
packaging aid	steel strap, wooden cover plate	
410070	Hydraulic Twin Hose RCS, 20 m	
amount	20	
load carrier	wire crate k	
packaging method	stacked	
packaging aid	steel strap, wooden cover plate	
410084	Scaffold Tube Adapter Ø 48 RCS	
amount	400	
load carrier	wire crate k	
packaging method	loose	
packaging aid	steel strap, wooden cover plate	

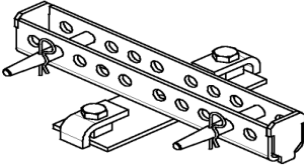

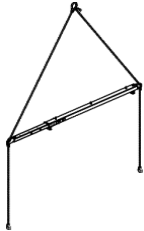
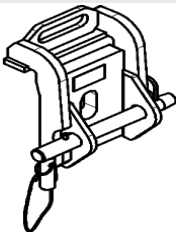
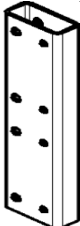
Article No.	Article Name	Article Image
410094	Carriage Crank Lever SW 19	
amount	1	
load carrier	loose	
packaging method	loose	
packaging aid		
410234	Crossbar RCS 103	
amount	36	
load carrier	wire crate k	
packaging method	6 wide, 6 up	
packaging aid	steel strap	
410280	Adapter Cable RCS	
amount	20	
load carrier	hardware box	
packaging method	loose	
packaging aid	steel strap, wooden cover plate	
410290	Timber Fixation RCS 12/20	
amount	200	
load carrier	wire crate k	
packaging method	5 layers, 6 x 6 per layer + 20	
packaging aid	steel strap, wooden cover plate	
410315	Mounting Ring Adapter RCS M30	
amount	60	
load carrier	wire crate k	
packaging method	stacked	
packaging aid	steel strap, wooden cover plate	
410330	Girder Fixation M20	
amount	100	
load carrier	hardware box	
packaging method	loose	
packaging aid	steel strap, wooden cover plate	
410375	Slab Shoe RCS Corner	
amount	12	
load carrier	wire crate k	
packaging method	stacked	
packaging aid	steel strap, wooden cover plate	

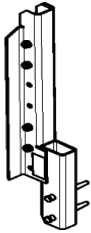
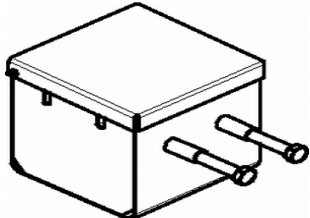
Article No.	Article Name	Article Image
410400	Adjusting Unit SRU, external	
amount	70	
load carrier	wire crate k	
packaging method	stacked	
packaging aid	steel strap, wooden cover plate	
410467	Crossbar RCS 133	
amount	18	
load carrier	post pallet RP 120	
packaging method	6 wide, 3 up	
packaging aid	steel strap	
410477	Spindle Adapter SLS/RCS	
amount	300	
load carrier	wire crate k	
packaging method	stacked	
packaging aid	steel strap, wooden cover plate	
410569	Climbing Rail Hinge RCS	
amount	50	
load carrier	wire crate k	
packaging method	stacked	
packaging aid	steel strap, wooden cover plate	
410608	Hatch 55 x 60, foldable	
amount	15	
load carrier	wire crate k	
packaging method	stacked	
packaging aid	steel strap, wooden cover plate	
410667	Wall Shoe RCS, pivoted	
amount	100	
load carrier	wire crate k	
packaging method	stacked	
packaging aid	steel strap, wooden cover plate	
410950	Excentric Lever RCS	
amount	1	
load carrier	loose	
packaging method	loose	
packaging aid		

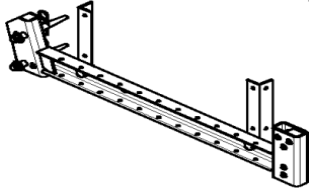
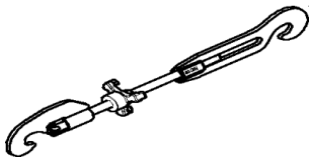

Article No.	Article Name	Article Image
411165	Ladder Connector VARIO, adjustable	
amount	50	
load carrier	wire crate k	
packaging method	stacked	
packaging aid	steel strap, wooden cover plate	
411283	Angle Connector RCS/SRU	
amount	70	
load carrier	wire crate k	
packaging method	stacked	
packaging aid	steel strap, wooden cover plate	
411382	Climbing Rail Angle Connector RCS	
amount	20	
load carrier	wire crate k	
packaging method	stacked	
packaging aid	steel strap, wooden cover plate	
411390	Climbing Rail Connector RCS 97	
amount	28	
load carrier	wire crate k	
packaging method	stacked	
packaging aid	steel strap, wooden cover plate	
411403	Mounting Castor Climbing Rail RCS	
amount	150	
load carrier	hardware box	
packaging method	loose	
packaging aid	steel strap, wooden cover plate	
411631	Crossbar RCS 69	
amount	80	
load carrier	wire crate k	
packaging method	stacked	
packaging aid	steel strap, wooden cover plate	
411833	Climbing Rail Connector RCS 40	
amount	60	
load carrier	wire crate k	
packaging method	stacked	
packaging aid	steel strap, wooden cover plate	

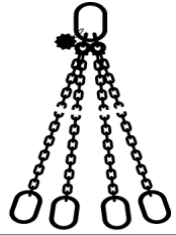
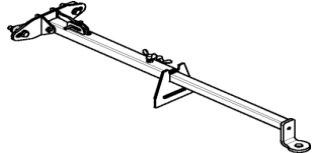
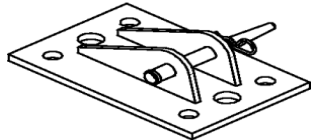
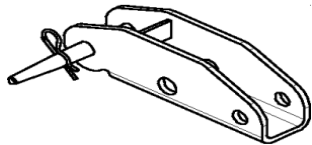
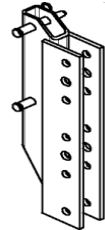
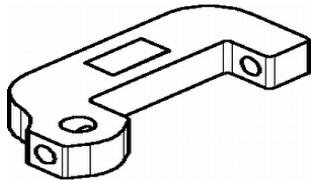

Article No.	Article Name	Article Image
412102	Climbing Rail RCS 298	
amount	10	
load carrier	bundle	
packaging method	bundeled	
packaging aid	steel strap, square timber, dunnage	
412141	Climbing Rail RCS 398	
amount	10	
load carrier	bundle	
packaging method	bundeled	
packaging aid	steel strap, square timber, dunnage	
412359	Slab Support Anchor Shoe RCS M24	
amount	25	
load carrier	wire crate k	
packaging method	stacked	
packaging aid	steel strap, wooden cover plate	
412421	Hydraulic Accumulate Piece RCS	
amount	60	
load carrier	hardware box	
packaging method	stacked	
packaging aid	steel strap, wooden cover plate	
412986	Lifting Beam RCS 10 t	
amount	6	
load carrier	post pallet RP 120	
packaging method	stacked	
packaging aid	steel strap	
413232	Slab Stopend Shoe RCS	
amount	100	
load carrier	wire crate k	
packaging method	stacked	
packaging aid	steel strap, wooden cover plate	
413744	Climbing Rail Connector RCS 73	
amount	56	
load carrier	wire crate k	
packaging method	stacked	
packaging aid	steel strap, wooden cover plate	

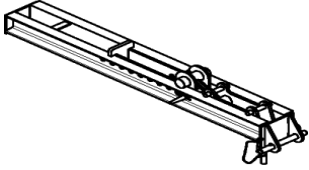
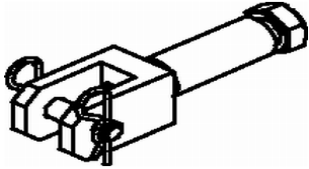
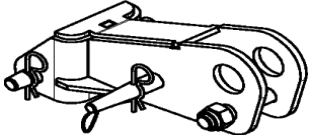
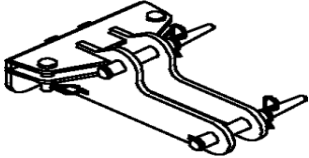
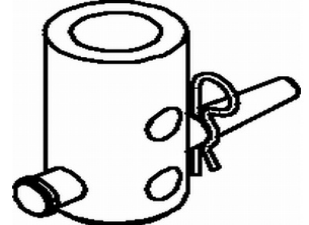
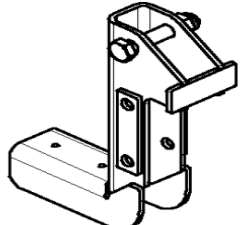
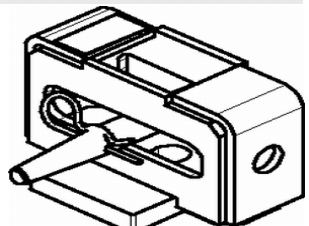
Article No.	Article Name	Article Image
413745	Climbing Rail Extension RCS 125	
amount	10	
load carrier	post pallet RP 120	
packaging method	stacked	
packaging aid	steel strap	
414154	Chain Box RCS Lift	
amount	12	
load carrier	wire crate k	
packaging method	stacked	
packaging aid	steel strap, wooden cover plate	
414166	Climbing Rail RCS 148	
amount	10	
load carrier	bundle	
packaging method	bundled	
packaging aid	steel strap, square timber, dunnage	
414301	Platform Beam RCS/SRU 113	
amount	21	
load carrier	wire crate k	
packaging method	3 wide, 7 up	
packaging aid	steel strap, wooden cover plate	
414317	Guide in Tool RCS	
amount	100	
load carrier	hardware box	
packaging method	loose	
packaging aid	steel strap, wooden cover plate	
414328	Guardrail Post RCS/SRU 184	
amount	72	
load carrier	post pallet RP 120	
packaging method	8 wide 9 up	
packaging aid	steel strap	
414655	Hoisting Troll RCS Lift 2T, electric	
amount	1	
load carrier	wire crate k	
packaging method	stacked	
packaging aid	steel strap, wooden cover plate	

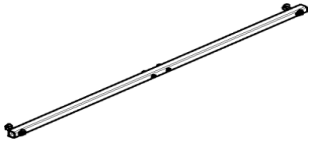
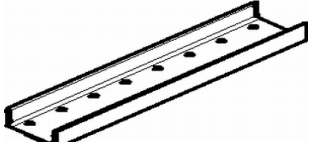
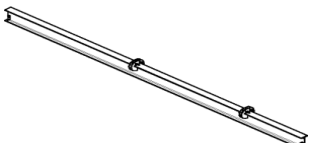
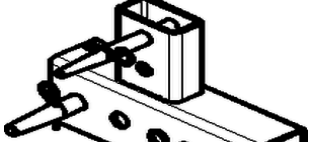
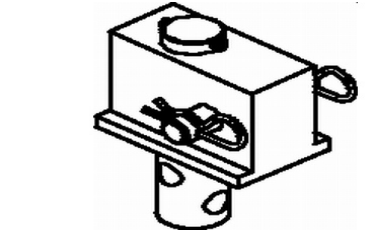
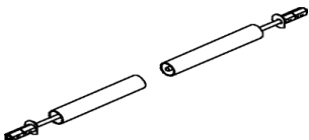
Article No.	Article Name	Article Image
414657	Chain Suspension RCS Lift	
amount	20	
load carrier	hardware box	
packaging method	in a bag	
packaging aid	steel strap, wooden cover plate	
414947	Slab Anchor Template 61 RCS	
amount	12	
load carrier	post pallet RP 120	
packaging method	4 wide, 3 up	
packaging aid	steel strap	
414997	Bracing Shoe RCS DW 15	
amount	120	
load carrier	wire crate k	
packaging method	loose	
packaging aid	steel strap, wooden cover plate	
415298	Spindle Shoe SLS/RCS M24	
amount	200	
load carrier	wire crate k	
packaging method	8 layers, 25 per layer	
packaging aid	steel strap, wooden cover plate	
415325	Strongback Adapter RCS/SRU	
amount	80	
load carrier	wire crate k	
packaging method	loose	
packaging aid	steel strap, wooden cover plate	
415375	Articulated Spanner RCS DW 15	
amount	150	
load carrier	wire crate k	
packaging method	loose	
packaging aid	steel strap, wooden cover plate	
415378	Eye Nut RCS DW 15	
amount	500	
load carrier	hardware box	
packaging method	loose	
packaging aid	steel strap, wooden cover plate	

Article No.	Article Name	Article Image
415570	Slab Shoe Adjustable RCS 30	
amount	9	
load carrier	post pallet RP 120	
packaging method	3 wide, 3 up	
packaging aid	steel strap	
415626	M24 Kicker Connector RCS	
amount	200	
load carrier	hardware box	
packaging method	loose	
packaging aid	steel strap, wooden cover plate	
415850	Slab Support Adapter RCS	
amount	50	
load carrier	wire crate k	
packaging method	5 layers, 10 per layer	
packaging aid	steel strap, wooden cover plate	
415918	SLAB SHOE ADAPTER RCS/AV/SLS	
amount	75	
load carrier	wire crate k	
packaging method	stacked	
packaging aid	steel strap, wooden cover plate	
416039	Spindle Adapter SKS/RCS	
amount	200	
load carrier	hardware box	
packaging method	loose	
packaging aid	steel strap, wooden cover plate	
416477	Platform Beam Support RCS	
amount	60	
load carrier	wire crate k	
packaging method	loose	
packaging aid	steel strap, wooden cover plate	
416538	Slab Support Alignment RCS	
amount	50	
load carrier	hardware box	
packaging method	loose	
packaging aid	steel strap, wooden cover plate	

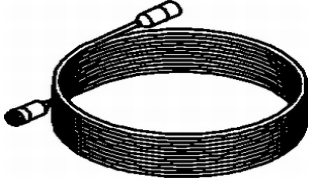
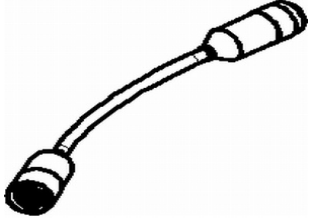
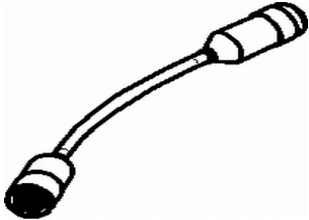
Article No.	Article Name	Article Image
416866	Horizontal Tube RCS ML 355	
amount	24	
load carrier	post pallet RP 150	
packaging method	stacked	
packaging aid	steel strap	
417259	Hoisting Trolly RCS ML 1,6T, electric	
amount	1	
load carrier	wire crate k	
packaging method	stacked	
packaging aid	steel strap, wooden cover plate	
417585	Climbing Rail Profile RCS 98	
amount	28	
load carrier	post pallet RP 120	
packaging method	stacked	
packaging aid	steel strap	
417758	Carriage Beam RCS ML 840	
amount	1	
load carrier	loose	
packaging method	loose	
packaging aid		
417763	End Adapter RCS/SRU	
amount	45	
load carrier	wire crate k	
packaging method	stacked	
packaging aid	steel strap, wooden cover plate	
417766	Bracing Connector SRU/DW 15	
amount	100	
load carrier	hardware box	
packaging method	loose	
packaging aid	steel strap, wooden cover plate	
418355	Horizontal Brace RCS ML 328	
amount	50	
load carrier	post pallet RP 150	
packaging method	stacked	
packaging aid	steel strap, square timber	

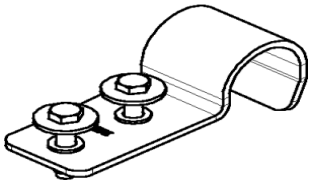
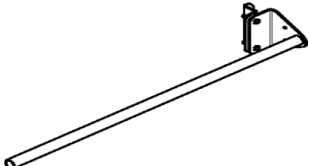
Article No.	Article Name	Article Image
423833	Remote Control for 2 Pumps ACS	
amount	12	
load carrier	wire crate k	
packaging method	loose	
packaging aid	steel strap, wooden cover plate	
423834	Extension Cable 18 m ACS	
amount	20	
load carrier	hardware box	
packaging method	loose	
packaging aid	steel strap, wooden cover plate	
423835	Adapter Cable 4-fold 2/03C ACS	
amount	20	
load carrier	hardware box	
packaging method	loose	
packaging aid	steel strap, wooden cover plate	
423837	Adapter Cable 6-fold 1/09C ACS	
amount	20	
load carrier	hardware box	
packaging method	loose	
packaging aid	steel strap, wooden cover plate	
425458	Flap Safety Plate LPS Ø 48	
amount	1000	
load carrier	hardware box	
packaging method	loose	
packaging aid	steel strap, wooden cover plate	
425461	Flap Hinge LPS Ø 48/M10	
amount	500	
load carrier	hardware box	
packaging method	loose	
packaging aid	steel strap, wooden cover plate	
425972	Telescopic Scaffold Tube LPS	
amount	80	
load carrier	wire crate k	
packaging method	stacked	
packaging aid	steel strap, wooden plate between each layer, wooden cover plate	

Article No.	Article Name	Article Image
426430	Adapter VT20 / RCS-P	
amount	250	
load carrier	hardware box	
packaging method	loose	
packaging aid	steel strap, wooden cover plate	
426538	Material Platform RCS-MP 375	
amount	1	
load carrier	loose	
packaging method	loose	
packaging aid		
426539	Material Platform RCS-MP 550	
amount	1	
load carrier	loose	
packaging method	loose	
packaging aid		

Article No.	Article Name	Article Image
320820	Outside Panel A 85 x 120	
amount	6	
load carrier	bundle	
packaging method	stacked	
packaging aid	plywood on plywood and T-waler on T-waler, dunnage	
320830	Inside Panel I 72 x 120	
amount	1	
load carrier	loose	
packaging method	stacked	
packaging aid		
320840	Outside Panel A 85 x 240	
amount	1	
load carrier	loose	
packaging method	stacked	
packaging aid		
320850	Inside Panel I 72 x 240	
amount	6	
load carrier	bundle	
packaging method	stacked	
packaging aid	plywood on plywood and T-waler on T-waler, dunnage	
320860	Outside Panel A 85 x 300	
amount	6	
load carrier	bundle	
packaging method	stacked	
packaging aid	plywood on plywood and T-waler on T-waler, dunnage	
320870	Inside Panel I 72 x 300	
amount	6	
load carrier	bundle	
packaging method	stacked	
packaging aid	plywood on plywood and T-waler on T-waler, dunnage	
320880	Outside Panel A 85 x 360	
amount	6	
load carrier	bundle	
packaging method	stacked	
packaging aid	plywood on plywood and T-waler on T-waler, dunnage	

Article No.	Article Name	Article Image
320890	Inside Panel I 72 x 360	
amount	6	
load carrier	bundle	
packaging method	stacked	
packaging aid	plywood on plywood and T-waler on T-waler, dunnage	
321110	Articulated Waler GRV 90	
amount	25	
load carrier	wire crate k	
packaging method	stacked	
packaging aid	steel strap, wooden cover plate	
321120	Articulated Waler GRV 75	
amount	30	
load carrier	wire crate k	
packaging method	stacked	
packaging aid	steel strap, wooden cover plate	
321130	Articulated Waler GRV 60	
amount	40	
load carrier	wire crate k	
packaging method	stacked	
packaging aid	steel strap, wooden cover plate	
321150	Articulated Spindle Waler GSRV 65 – 90	
amount	30	
load carrier	wire crate k	
packaging method	stacked	
packaging aid	steel strap, wooden cover plate	
321160	Hook Spanner HKS for GRV	
amount	1	
load carrier	loose	
packaging method	loose	
packaging aid		
321240	Adjusting Bolt STS 260, galv.	
amount	500	
load carrier	hardware box	
packaging method	stacked	
packaging aid	steel strap, wooden cover plate	

Article No.	Article Name	Article Image
321250	Adjusting Bolt STS 360, galv.	
amount	500	
load carrier	hardware box	
packaging method	stacked	
packaging aid	steel strap, wooden cover plate	
321260	Half Round Washer HRS, galv.	
amount	200	
load carrier	hardware box	
packaging method	loose	
packaging aid	steel strap, wooden cover plate	
321270	GRV Bearing Block, left	
amount	36 or 72	
load carrier	hardware box or wire crate k	
packaging method	stacked	
packaging aid	steel strap, wooden cover plate	
321280	GRV Bearing Block, right	
amount	36 or 72	
load carrier	hardware box or wire crate k	
packaging method	stacked	
packaging aid	steel strap, wooden cover plate	
321290	GRV Spindle Connector	
amount	200	
load carrier	wire crate k	
packaging method	stacked	
packaging aid	steel strap, wooden cover plate	
321400	Outside Panel A 250 x 300	
amount	1	
load carrier	loose	
packaging method	stacked	
packaging aid	plywood on plywood and T-waler on T-waler	
321410	Inside Panel I 240 x 300	
amount	1	
load carrier	loose	
packaging method	stacked	
packaging aid	plywood on plywood and T-waler on T-waler	

Article No.	Article Name	Article Image
321420	Outside Panel A 128 x 300	
amount	6	
load carrier	bundle	
packaging method	stacked	
packaging aid	plywood on plywood and T-waler on T-waler, dunnage	
321430	Inside Panel I 123 x 300	
amount	6	
load carrier	bundle	
packaging method	stacked	
packaging aid	plywood on plywood and T-waler on T-waler, dunnage	
321580	T-Waler 800, Painted	
amount	32	
load carrier	wire crate k	
packaging method	stacked	
packaging aid	steel strap, wooden cover plate	
321600	T-Waler	
amount	52	
load carrier	wire crate k	
packaging method	stacked	
packaging aid	steel strap, wooden cover plate	
321610	Adjusting Spindle 210, galv.	
amount	300	
load carrier	wire crate k	
packaging method	6 layers, 50 per layer	
packaging aid	steel strap, wooden cover plate	
321620	Adjusting Spindle 500, galv.	
amount	150	
load carrier	wire crate k	
packaging method	7 layers, 20 per layer + 10	
packaging aid	steel strap, wooden cover plate	
321630	Distribution Waler	
amount	40	
load carrier	wire crate k	
packaging method	10 wide, 4 up	
packaging aid	steel strap, wooden cover plate	

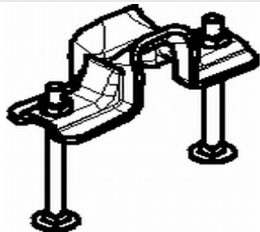
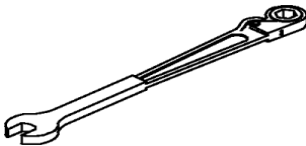
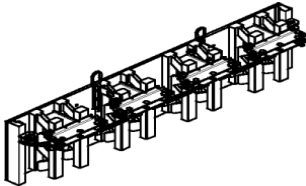
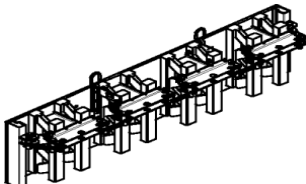
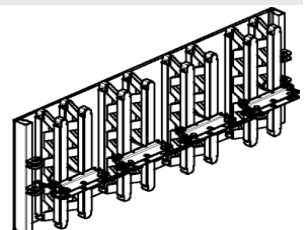
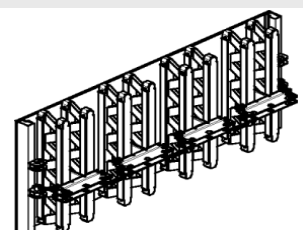
Article No.	Article Name	Article Image
321650	Edge Girder Strap, galv.	
amount	1200	
load carrier	wire crate k	
packaging method	loose	
packaging aid	steel strap, wooden cover plate	
321660	RUNDFLEX Strap 24	
amount	2000	
load carrier	wire crate k	
packaging method	loose	
packaging aid	steel strap, wooden cover plate	
321790	Ratchet Spanner SW 24 "Combi"	
amount	1	
load carrier	loose	
packaging method	loose	
packaging aid		
321800	Outside Panel A 250 x 60	
amount	6	
load carrier	bundle	
packaging method	stacked	
packaging aid	plywood on plywood and T-waler on T-waler, dunnage	
321810	Inside Panel I 240 x 60	
amount	6	
load carrier	bundle	
packaging method	stacked	
packaging aid	plywood on plywood and T-waler on T-waler, dunnage	
321820	Outside Panel A 250 x 120	
amount	6	
load carrier	bundle	
packaging method	stacked	
packaging aid	plywood on plywood and T-waler on T-waler, dunnage	
321830	Inside Panel I 240 x 120	
amount	6	
load carrier	bundle	
packaging method	stacked	
packaging aid	plywood on plywood and T-waler on T-waler, dunnage	

Article No.	Article Name	Article Image
321840	Outside Panel A 250 x 240	
amount	1	
load carrier	loose	
packaging method	stacked	
packaging aid	plywood on plywood and T-waler on T-waler	
321850	Inside Panel I 240 x 240	
amount	1	
load carrier	loose	
packaging method	stacked	
packaging aid	plywood on plywood and T-waler on T-waler	
321880	Outside Panel A 250 x 360	
amount	1	
load carrier	loose	
packaging method	stacked	
packaging aid	plywood on plywood and T-waler on T-waler	
321890	Inside Panel I 240 x 360	
amount	1	
load carrier	loose	
packaging method	stacked	
packaging aid	plywood on plywood and T-waler on T-waler	
321900	Outside Panel A 128 x 60	
amount	6	
load carrier	bundle	
packaging method	stacked	
packaging aid	plywood on plywood and T-waler on T-waler, dunnage	
321910	Inside Panel I 123 x 60	
amount	6	
load carrier	bundle	
packaging method	stacked	
packaging aid	plywood on plywood and T-waler on T-waler, dunnage	
321920	Outside Panel A 128 x 120	
amount	6	
load carrier	bundle	
packaging method	stacked	
packaging aid	plywood on plywood and T-waler on T-waler, dunnage	

Article No.	Article Name	Article Image
321930	Inside Panel I 123 x 120	
amount	6	
load carrier	bundle	
packaging method	stacked	
packaging aid	plywood on plywood and T-waler on T-waler, dunnage	
321940	Outside Panel A 128 x 240	
amount	6	
load carrier	bundle	
packaging method	stacked	
packaging aid	plywood on plywood and T-waler on T-waler, dunnage	
321950	Inside Panel I 123 x 240	
amount	6	
load carrier	bundle	
packaging method	stacked	
packaging aid	plywood on plywood and T-waler on T-waler, dunnage	
321960	Outside Panel A 128 x 360	
amount	6	
load carrier	bundle	
packaging method	stacked	
packaging aid	plywood on plywood and T-waler on T-waler, dunnage	
321970	Inside Panel I 123 x 360	
amount	6	
load carrier	bundle	
packaging method	stacked	
packaging aid	plywood on plywood and T-waler on T-waler, dunnage	
321980	Crane Eye 24, left	
amount	200	
load carrier	wire crate k	
packaging method	loose	
packaging aid	steel strap, wooden cover plate	
321990	Crane Eye 24, right	
amount	200	
load carrier	wire crate k	
packaging method	loose	
packaging aid	steel strap, wooden cover plate	



Article No.	Article Name	Article Image
322210	Pin for GRB, galv.	
amount	200	
load carrier	hardware box	
packaging method	loose	
packaging aid	steel strap, wooden cover plate	
322230	Cotter Pin 5/1, galv.	
amount	250	
load carrier	bag	
packaging method	loose	
packaging aid		
322250	Nut ISO 4032 M24-8, galv.	
amount	1000	
load carrier	hardware box	
packaging method	stacked	
packaging aid	steel strap, wooden cover plate	
402853	Inside Panel I 123/120 2R	
amount	1	
load carrier	loose	
packaging method	stacked	
packaging aid		
402854	Outside Panel A 128 x 120 2R	
amount	1	
load carrier	loose	
packaging method	stacked	
packaging aid		
402855	Inside Panel I 240 x 120 2R	
amount	1	
load carrier	loose	
packaging method	stacked	
packaging aid		
402856	Outside Panel A 250 x 120 2R	
amount	1	
load carrier	loose	
packaging method	stacked	
packaging aid		

Article No.	Article Name	Article Image
409411	Ladder Connector RFP	
amount	50	
load carrier	wire crate k	
packaging method	loose	
packaging aid	steel strap, wooden cover plate	
409420	Ladder Safety Cage RFP 200	
amount	4	
load carrier	post pallet RP 150	
packaging method	stacked into each other	
packaging aid	steel strap	
414871	Ladder RFP 90	
amount	20	
load carrier	wire crate k	
packaging method	stacked	
packaging aid	steel strap, wooden cover plate	
426043	Inside Panel I 240 x 180	
amount	6	
load carrier	bundle	
packaging method	stacked	
packaging aid	plywood on plywood and T-waler on T-waler	
426067	Inside Panel I 123 x 180	
amount	6	
load carrier	bundle	
packaging method	stacked	
packaging aid	plywood on plywood and T-waler on T-waler, dunnage	
426070	Inside Panel I 72 x 180	
amount	6	
load carrier	bundle	
packaging method	stacked	
packaging aid	plywood on plywood and T-waler on T-waler, dunnage	
426073	Outside Panel A 250 x 180	
amount	6	
load carrier	bundle	
packaging method	stacked	
packaging aid	plywood on plywood and T-waler on T-waler, dunnage	

Article No.	Article Name	Article Image
426075	Outside Panel A 128 x 180	
amount	6	
load carrier	bundle	
packaging method	stacked	
packaging aid	plywood on plywood and T-waler on T-waler, dunnage	
426079	Outside Panel A 85 x 180	
amount	6	
load carrier	bundle	
packaging method	stacked	
packaging aid	plywood on plywood and T-waler on T-waler, dunnage	

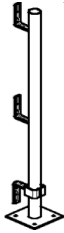
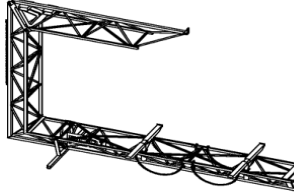
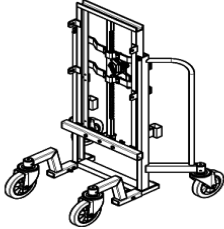
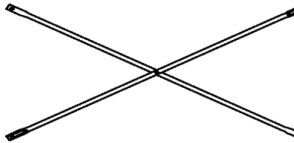
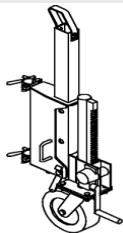

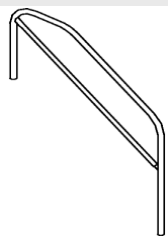
Article No.	Article Name	Article Image
318050	Pin Ø 16 x 65/86, galv.	
amount	50	
load carrier	bag	
packaging method	loose	
packaging aid		
318060	Cotter Pin 4/1, galv.	
amount	250	
load carrier	bag	
packaging method	loose	
packaging aid		
318090	Screw-on Locking Angle ASW, galv.	
amount	500	
load carrier	hardware box	
packaging method	loose	
packaging aid	steel strap, wooden cover plate	
318140	Connector with Washer, galv.	
amount	250	
load carrier	hardware box	
packaging method	loose	
packaging aid	steel strap, wooden cover plate	
318150	Diagonal Brace DK 125, galv.	
amount	100	
load carrier	post pallet RP 120	
packaging method	4 bundles, 25 per bundle	
packaging aid	steel strap	
318520	Frame R 110, galv.	
amount	20	
load carrier	bundle	
packaging method	upright	
packaging aid	steel strap	
318630	Cross Head Spindle TR 48-75/47, galv.	
amount	35	
load carrier	wire crate k	
packaging method	stacked	
packaging aid	steel strap, wooden cover plate	

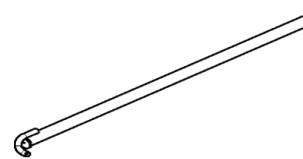
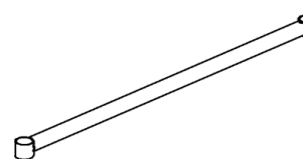
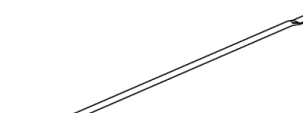
Article No.	Article Name	Article Image
319040	Guardrail Post PD 8	
amount	48	
load carrier	post pallet RP 120	
packaging method	8 wide, 6 up	
packaging aid	steel strap, dunnage	
319130	C-Hook 15kN, galv.	
amount	1	
load carrier	loose	
packaging method	loose	
packaging aid	steel strap, dunnage	
319200	Trolley with Winch	
amount	1	
load carrier	loose	
packaging method	loose	
packaging aid		
319210	Diagonal Brace DK 186, galv.	
amount	100	
load carrier	post pallet RP 150	
packaging method	4 bundles, 25 per bundle	
packaging aid	steel strap	
319240	Transport Wheel 80	
amount	8	
load carrier	post pallet RP 120	
packaging method	stacked	
packaging aid	steel strap	
319270	Diagonal Strut 310, galv.	
amount	200	
load carrier	post pallet RP 150	
packaging method	4 bundles, 50 per bundle	
packaging aid	steel strap	
319330	Horizontal Strut HS 292, galv.	
amount	200	
load carrier	post pallet RP 150	
packaging method	4 bundles, 50 per bundle	
packaging aid	steel strap	

Article No.	Article Name	Article Image
319410	Stair Handrail, galv.	
amount	20	
load carrier	post pallet RP 120	
packaging method	stacked	
packaging aid	steel strap	
319430	Flight of Stairs -Steel Grating, galv.	
amount	5	
load carrier	bundle	
packaging method	lying on side	
packaging aid	steel strap, square timber	
319460	Return Angle for Stair Tower, galv.	
amount	as required	
load carrier	wire crate k	
packaging method	loose	
packaging aid		
319550	Stair Tower Stabilizer special length, galv.	
amount	as required	
load carrier	post pallet RP 150	
packaging method	stacked	
packaging aid	steel strap	
319630	Reinforcing Support PD8, galv.	
amount	63	
load carrier	post pallet RP 120	
packaging method	stacked	
packaging aid	steel strap	
319640	Load Tower Brace LS 186, galv.	
amount	200	
load carrier	post pallet RP 150	
packaging method	4 bundles, 50 per bundle	
packaging aid	steel strap	
319650	Load Tower Brace LS 165, galv.	
amount	200	
load carrier	post pallet RP 150	
packaging method	4 bundles, 50 per bundle	
packaging aid	steel strap	

Article No.	Article Name	Article Image
401862	Lifting Fork 1 t / 5.0 m	
amount	1	
load carrier	post pallet RP 150	
packaging method	loose	
packaging aid	steel strap, square timber	
402210	Back Stop Lifting Fork 1 t / 5,0 m	
amount	20	
load carrier	wire crate k	
packaging method	loose	
packaging aid	steel strap, wooden cover plate	
403212	Lifting Fork 1.75 t / 8.0 m	
amount	1	
load carrier	loose	
packaging method	loose	
packaging aid	steel strap, square timber	
412230	Lifting Fork 1.25 t / 6.0 m compl.	
amount	1	
load carrier	loose	
packaging method	loose	
packaging aid	steel strap, square timber	
415865	Lifting Fork 1.5 t / 8.0 m / 6.6 m	
amount	1	
load carrier	loose	
packaging method	loose	
packaging aid		
417954	Connector Rosett Plus – Trolley	
amount	8	
load carrier	hardware box	
packaging method	bundled in pairs	
packaging aid	steel strap, wooden cover plate	
418114	Connector MP – Trolley	
amount	8	
load carrier	hardware box	
packaging method	bundled in pairs	
packaging aid	steel strap, wooden cover plate	

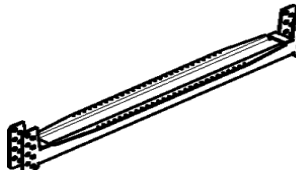
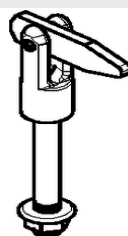
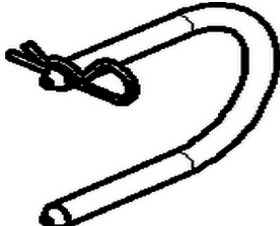
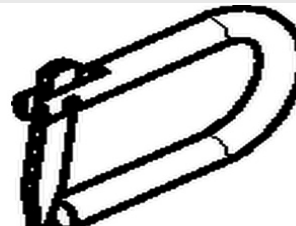
Article No.	Article Name	Article Image
418605	Connector Rosett – Trolley	
amount	8	
load carrier	hardware box	
packaging method	bundled in pairs	
packaging aid	steel strap, wooden cover plate	
432457	PD 5 Beam Spindle	
amount	35	
load carrier	post pallet RP 120	
packaging method	stacked	
packaging aid	steel strap	
432464	PD 5 Frame 100	
amount	20	
load carrier	bundle	
packaging method	standing	
packaging aid	steel strap	
432468	PD 5 Frame 150	
amount	20	
load carrier	bundle	
packaging method	standing	
packaging aid	steel strap	
432470	PD 5 Diagonal Brace 150	
amount	100	
load carrier	post pallet RP 120	
packaging method	stacked	
packaging aid	steel strap	
432472	PD 5 Diagonal Brace 200	
amount	100	
load carrier	post pallet RP 120	
packaging method	stacked	
packaging aid	steel strap	
432474	PD 5 Diagonal Brace 250	
amount	100	
load carrier	post pallet RP 120	
packaging method	stacked	
packaging aid	steel strap	

Article No.	Article Name	Article Image
432540	PD 5 Beam Waler	
amount	30	
load carrier	post pallet RP 120	
packaging method	5 wide, 6 up	
packaging aid	steel strap, dunnage	
432541	Screwable Flip Lock	
amount	1000	
load carrier	hardware box	
packaging method	10 bags, 100 per bag	
packaging aid	steel strap, wooden cover plate	
432544	Double Pin Beam Waler	
amount	500	
load carrier	post pallet RP 120	
packaging method	10 bags, 50 per bag	
packaging aid	steel strap, wooden cover plate	
432550	Double Pin Frame	
amount	500	
load carrier	hardware box	
packaging method	10 bags, 50 per bag	
packaging aid	steel strap, wooden cover plate	
432584	Base Spindle TR 48-75/55	
amount	150	
load carrier	wire crate k	
packaging method	stacked	
packaging aid	steel strap, wooden cover plate	
432864	PD 5 Spindle Safety Strap	
amount	1000	
load carrier	hardware box	
packaging method	10 bags, 100 per bag	
packaging aid	steel strap, wooden cover plate	

Article No.	Article Name	Article Image
317000	Swivel Coupling DK 60/48, galv.	
amount	300	
load carrier	hardware box	
packaging method	loose	
packaging aid	steel strap, wooden cover plate	
317010	Swivel Coupling DK 48/48, galv.	
amount	300	
load carrier	hardware box	
packaging method	loose	
packaging aid	steel strap, wooden cover plate	
317020	Standard Coupler NK 48/48, galv.	
amount	300	
load carrier	hardware box	
packaging method	loose	
packaging aid	steel strap, wooden cover plate	
317030	Double Coupler NK 60/48, galv.	
amount	300	
load carrier	hardware box	
packaging method	loose	
packaging aid	steel strap, wooden cover plate	
317040	Screw-On Coupler AK 48, galv.	
amount	300	
load carrier	hardware box	
packaging method	loose	
packaging aid	steel strap, wooden cover plate	
317070	Swivel Coupling DK 33.7/38, galv.	
amount	300	
load carrier	hardware box	
packaging method	loose	
packaging aid	steel strap, wooden cover plate	
319780	Base Spindle TR 38-70/50	
amount	150	
load carrier	wire crate k	
packaging method	stacked	
packaging aid	steel strap, wooden cover plate	

Article No.	Article Name	Article Image
319790	Head Spindle TR 38-70/50, galv.	
amount	100	
load carrier	wire crate k	
packaging method	stacked	
packaging aid	steel strap, wooden cover plate	
319800	Spindle Safety Strap ST 100	
amount	100	
load carrier	bag	
packaging method	10 per bundle, 10 bundles per bag	
packaging aid		
319900	Base-Head Frame ST 100, galv.	
amount	30	
load carrier	euro pallet	
packaging method	stacked	
packaging aid	steel strap	
319910	Stacking Frame ST 100, galv.	
amount	80	
load carrier	pallet ST 100	
packaging method	stacked	
packaging aid	steel strap	
319920	End Waler ST 100	
amount	as required	
load carrier	wire crate k	
packaging method	stacked	
packaging aid	steel strap	
319930	End Frame ST 100	
amount	40	
load carrier	wire crate k	
packaging method	stacked	
packaging aid		
319940	Diagonal Strut ST 100, galv.	
amount	200	
load carrier	post pallet RP 120	
packaging method	stacked, 4 bundles, 50 per bundle	
packaging aid	steel strap	

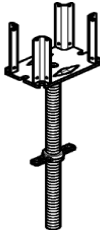
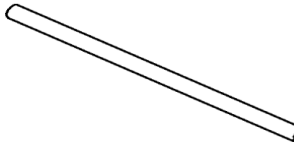
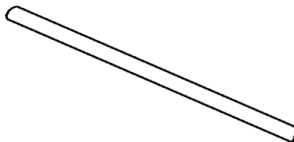
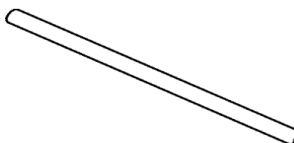
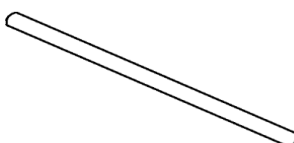
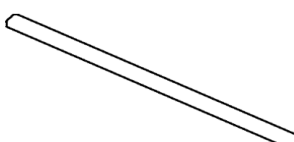
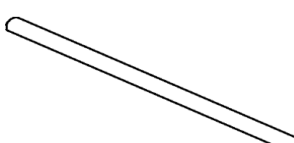
Article No.	Article Name	Article Image
319950	Cross Forkhead TR 38-70/50	
amount	40	
load carrier	wire crate k	
packaging method	stacked	
packaging aid	steel strap, wooden cover plate	
326411	Scaff. Tube Steel Ø 48.3 x 3.2, l = 1.0 m	
amount	176	
load carrier	wire crate k	
packaging method	16 wide, 11 up	
packaging aid	steel strap, wooden cover plate	
326412	Scaff. Tube Steel Ø 48.3 x 3.2, l = 2.0 m	
amount	104	
load carrier	post pallet RP 150	
packaging method	13 wide, 8 up	
packaging aid	steel strap, square timber	
326413	Scaff. Tube Steel Ø 48.3 x 3.2, l = 3.0 m	
amount	104	
load carrier	post pallet RP 150	
packaging method	13 wide, 8 up	
packaging aid	steel strap, square timber	
326414	Scaff. Tube Steel Ø 48.3 x 3.2, l = 4.0 m	
amount	104	
load carrier	post pallet RP 150	
packaging method	13 wide, 8 up	
packaging aid	steel strap, square timber	
326418	Scaff. Tube Steel Ø 48.3 x 3.2, l = 6.0 m	
amount	65	
load carrier	post pallet RP 150	
packaging method	13 wide, 5 up	
packaging aid	steel strap, square timber	
326419	Scaff. Tube Steel Ø 48.3 x 3.2, l = 5.0 m	
amount	65	
load carrier	post pallet RP 150	
packaging method	13 wide, 5 up	
packaging aid	steel strap, square timber	

Article No.	Article Name	Article Image
402400	Swivel Coupling DK 38/48, galv.	
amount	300	
load carrier	hardware box	
packaging method	loose	
packaging aid	steel strap, wooden cover plate	
416081	Head Spindle-2 TR 38-70/50	
amount	80	
load carrier	wire crate k	
packaging method	stacked	
packaging aid	steel strap, wooden cover plate	
416800	Connection Transportation Wheel ST 100	
amount	30	
load carrier	wire crate k	
packaging method	loose	
packaging aid	steel strap, wooden cover plate	

Article No.	Article Name	Article Image
337150	Tie Yoke DW 15	
amount	600	
load carrier	hardware box	
packaging method	loose	
packaging aid	steel strap, wooden cover plate	
337160	Bolt Ø 20 x 205, galv.	
amount	500	
load carrier	hardware box	
packaging method	loose	
packaging aid	steel strap, wooden cover plate	
337190	Brace Connector-3 RAPID, galv.	
amount	100	
load carrier	hardware box	
packaging method	loose	
packaging aid	steel strap, wooden cover plate	
337250	Column Frame RAPID 300, Alu	
amount	4	
load carrier	bundle	
packaging method	stacked laid	
packaging aid	steel strap, 10 cm square timber	
337260	Column Frame RAPID 210, Alu	
amount	4	
load carrier	bundle	
packaging method	stacked laid	
packaging aid	steel strap, 10 cm square timber	
337270	Column Frame RAPID 60, Alu	
amount	8	
load carrier	wire crate k	
packaging method	2 wide, 4 up	
packaging aid	steel strap, wooden cover plate	
337320	Crane Lifting Unit-2 RAPID	
amount	40	
load carrier	wire crate k	
packaging method	loose	
packaging aid	steel strap, wooden cover plate	



Article No.	Article Name	Article Image
337400	Concreting Platform, compl.	
amount	1	
load carrier	euro pallet	
packaging method	railings lying on platform	
packaging aid	steel strap	
337410	Concreting Landing, Alu	
amount	1	
load carrier	euro pallet	
packaging method	stacked	
packaging aid	steel strap	
337420	Platform Guardrail 52, galv.	
amount	30	
load carrier	post pallet RP 120	
packaging method	2 wide, 14 up + 2 upright	
packaging aid	steel strap	
337430	Platform Guardrail 134, galv.	
amount	13	
load carrier	post pallet RP 120	
packaging method	stacked	
packaging aid	steel strap	
337440	Crane Hook Concreting Platform	
amount	168	
load carrier	wire crate k	
packaging method	6 layers, 28 per layer	
packaging aid	steel strap, wooden plate between each layer, wooden cover plate	
337520	QUATTRO Panel QE 50	
amount	12	
load carrier	wire crate k	
packaging method	stacked	
packaging aid	steel strap, wooden cover plate	
337530	Brace Connector QUATTRO QR	
amount	200	
load carrier	hardware box	
packaging method	stacked	
packaging aid	steel strap, wooden cover plate	

Article No.	Article Name	Article Image
337540	Frame Spanner QUATTRO QA	
amount	100	
load carrier	hardware box	
packaging method	stacked	
packaging aid	steel strap, wooden cover plate	
337550	Base Plate QUATTRO QB	
amount	150	
load carrier	wire crate k	
packaging method	stacked	
packaging aid	steel strap, wooden cover plate	
403362	Ladder Connector TRIO	
amount	35	
load carrier	wire crate k	
packaging method	stacked	
packaging aid	steel strap, wooden cover plate	
403369	Ladder Connector RAPID, galv.	
amount	40	
load carrier	wire crate k	
packaging method	stacked	
packaging aid	steel strap, wooden cover plate	
403391	Ladder Connection QUATTRO	
amount	60	
load carrier	wire crate k	
packaging method	stacked	
packaging aid	steel strap, wooden cover plate	
404064	Vario Ladder Connection	
amount	40	
load carrier	wire crate k	
packaging method	loose	
packaging aid	steel strap, wooden cover plate	
405400	Pin Ø 20 x 140, galv.	
amount	300	
load carrier	hardware box	
packaging method	loose	
packaging aid	steel strap, wooden cover plate	



Article No.	Article Name	Article Image
405791	Transportation Wheel QUATTRO	
amount	30	
load carrier	wire crate k	
packaging method	loose	
packaging aid	steel strap, wooden cover plate	
409923	QUATTRO Frame QES 50	
amount	8	
load carrier	wire crate k	
packaging method	2 rows, 4 per row upright	
packaging aid	steel strap	
409924	QUATTRO Frame QES 125	
amount	4	
load carrier	bundle	
packaging method	stacked on top of each other, plywood downwards	
packaging aid	steel strap, square timber, dunnage	
409925	QUATTRO Frame QES 275	
amount	4	
load carrier	bundle	
packaging method	stacked on top of each other, plywood downwards	
packaging aid	steel strap, square timber, dunnage	
409926	QUATTRO Frame QES 350	
amount	4	
load carrier	bundle	
packaging method	stacked on top of each other, plywood downwards	
packaging aid	steel strap, square timber	
411683	COLUMN PANEL LICO 700 X 3000	
amount	10	
load carrier	bundle	
packaging method	stacked	
packaging aid	steel strap, stacking device, dunnage	
411957	Column Panel LICO 700 x 1000	
amount	10	
load carrier	bundle	
packaging method	stacked	
packaging aid	steel strap, stacking device, dunnage	

Article No.	Article Name	Article Image
411964	COLUMN PANEL LICO 700 x 500	
amount	10	
load carrier	bundle	
packaging method	stacked	
packaging aid	steel strap, stacking device, dunnage	
415352	Platform Front Guardrail 86/86	
amount	10	
load carrier	post pallet USP 104	
packaging method	stacked	
packaging aid	steel strap	
415894	CONCRETING PLATFORM LICO	
amount	7	
load carrier	post pallet RP 120	
packaging method	stacked	
packaging aid	steel strap	
427260	Quattro Ladder Adapter-2	
amount	12	
load carrier	wire crate k	
packaging method	6 wide, 2 up	
packaging aid	steel strap, wooden plate between each layer, wooden cover plate	

Article No.	Article Name	Article Image
410038	Standard Element GFP 200 x 100	
amount	10	
load carrier	stacking device Gridflex	
packaging method	stacked	
packaging aid	steel strap	
410040	Filler Element Cross GFC 200 x 100	
amount	10	
load carrier	stacking device Gridflex	
packaging method	stacked	
packaging aid	steel strap	
410045	Traverse GFT	
amount	117	
load carrier	wire crate k	
packaging method	stacked	
packaging aid	steel strap, wooden cover plate	
410238	Wall Holder GFW	
amount	49	
load carrier	post pallet RP 120	
packaging method	7 wide, 7 up	
packaging aid	steel strap, wooden strip between each layer	
410326	Guardrail GF 100	
amount	14	
load carrier	post pallet RP 120	
packaging method	stacked	
packaging aid	steel strap	
410486	Filler Element Longitudinal GFL 150 x 100	
amount	10	
load carrier	stacking device Gridflex	
packaging method	stacked	
packaging aid	steel strap, square timber	
410646	Filler Element Longitudinal GFL 183 x 20	
amount	24	
load carrier	post pallet RP 120	
packaging method	8 wide, 3 up	
packaging aid	steel strap	

Article No.	Article Name	Article Image
411108	Main Beam BD 300	
amount	21	
load carrier	post pallet RP 150	
packaging method	7 wide, 3 up	
packaging aid	steel strap	
411115	Wall Holder BD	
amount	56	
load carrier	post pallet RP 120	
packaging method	8 wide, 7 up	
packaging aid	steel strap	
411260	Cross Beam BD 210	
amount	30	
load carrier	post pallet RP 150	
packaging method	10 wide, 3 up	
packaging aid	steel strap	

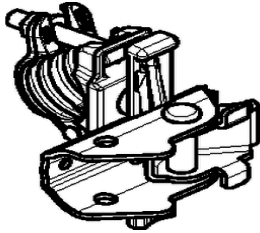
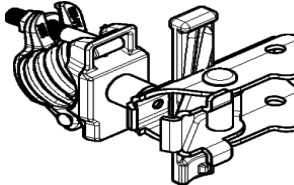
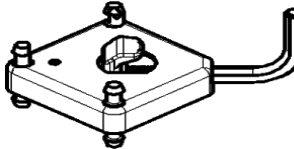
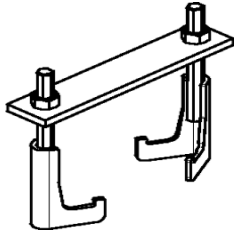
Article No.	Article Name	Article Image
327288	MULTIPROP MP 120	
amount	35	
load carrier	wire crate k	
packaging method	5 x 5 lying, 10 upright	
packaging aid	steel strap, wooden cover plate	
327289	MULTIPROP MP 250	
amount	25	
load carrier	post pallet RP 150	
packaging method	8 wide, 5 up	
packaging aid	steel strap, dunnage 2x per layer	
327290	MULTIPROP MP 350	
amount	25	
load carrier	post pallet RP 150	
packaging method	8 wide, 5 up	
packaging aid	steel strap, dunnage 2x per layer	
327291	MULTIPROP MP 480	
amount	25	
load carrier	post pallet RP 150	
packaging method	8 wide, 5 up	
packaging aid	steel strap, dunnage 2x per layer	
327295	MULTIPROP Extension MPT 200	
amount	40	
load carrier	bundle	
packaging method	8 wide, 5 up	
packaging aid	steel strap	
327296	Tilting Base MKF	
amount	100	
load carrier	wire crate k	
packaging method	stacked	
packaging aid	steel strap, wooden cover plate	
327297	Tilting Forkhead MKK	
amount	50	
load carrier	wire crate k	
packaging method	stacked	
packaging aid	steel strap, wooden cover plate	

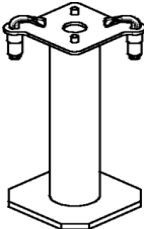
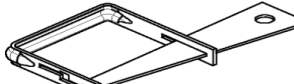
Article No.	Article Name	Article Image
327298	Scaffold Tube Coupler MG-A/C	
amount	500	
load carrier	wire crate k	
packaging method	loose	
packaging aid	steel strap, wooden cover plate	
327299	Scaffold Tube Coupler MG-B/D	
amount	500	
load carrier	wire crate k	
packaging method	loose	
packaging aid	steel strap, wooden cover plate	
327301	Connector MPV-2	
amount	1000	
load carrier	wire crate k	
packaging method	loose	
packaging aid	steel strap, wooden cover plate	
327302	MULTIPROP Strap SRZ U100 – U140	
amount	250	
load carrier	wire crate k	
packaging method	loose	
packaging aid	steel strap, wooden cover plate	
327305	MULTIPROP MP 625	
amount	25	
load carrier	post pallet RP 150	
packaging method	8 wide, 5 up	
packaging aid	steel strap, dunnage 2x per layer	
327310	Base MP 50	
amount	50	
load carrier	wire crate k	
packaging method	stacked	
packaging aid	steel strap, wooden cover plate	
327790	Brace Clamp HL, galv., 76 – 120 mm	
amount	200	
load carrier	wire crate k	
packaging method	loose	
packaging aid	steel strap, wooden cover plate	

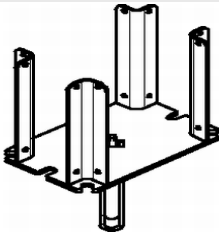
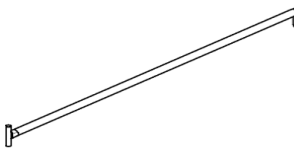
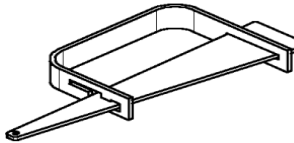
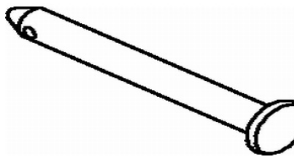
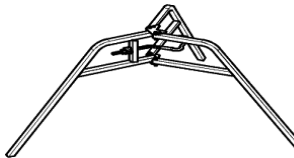
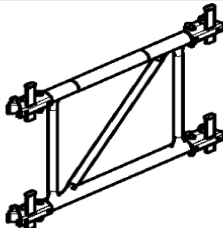
Article No.	Article Name	Article Image
327860	Tripod, galv.	
amount	25	
load carrier	wire crate k	
packaging method	stacked	
packaging aid		
327890	Crosshead 20/24, galv.	
amount	80	
load carrier	wire crate k	
packaging method	stacked	
packaging aid	steel strap	
327930	Assembly Bar 24, galv.	
amount	1	
load carrier	loose	
packaging method	loose	
packaging aid		
327940	Brace Clamp, galv., 48 – 76 mm	
amount	250	
load carrier	wire crate k	
packaging method	stacked	
packaging aid	steel strap, wooden cover plate	
327990	Bolt Ø 14 x 107, galv.	
amount	2000	
load carrier	hardware box	
packaging method	loose	
packaging aid	steel strap, wooden cover plate	
328000	Universal Tripod, galv.	
amount	40	
load carrier	euro palle	
packaging method	stacked	
packaging aid	steel strap, wooden cover plate	
328330	Frame MRK 90	
amount	36	
load carrier	euro pallet	
packaging method	2 wide, 20 up	
packaging aid	steel strap	

Article No.	Article Name	Article Image
328340	Frame MRK 120	
amount	36	
load carrier	euro pallet	
packaging method	2 wide, 20 up	
packaging aid	steel strap	
328350	Frame MRK 150	
amount	36	
load carrier	euro pallet	
packaging method	2 wide, 20 up	
packaging aid	steel strap	
328360	Frame MRK 225	
amount	36	
load carrier	euro palle	
packaging method	2 wide, 20 up	
packaging aid	steel strap	
328370	Frame MRK 296	
amount	36	
load carrier	euro palle	
packaging method	2 wide, 20 up	
packaging aid	steel strap	
328380	Frame MRK 137.5	
amount	36	
load carrier	euro pallet	
packaging method	2 wide, 20 up	
packaging aid	steel strap	
328390	Frame MRK 62.5	
amount	32	
load carrier	wire crate k	
packaging method	stacked	
packaging aid	steel strap, wooden cover plate	
328400	Frame MRK 75	
amount	32	
load carrier	wire crate k	
packaging method	stacked	
packaging aid	steel strap, wooden cover plate	

Article No.	Article Name	Article Image
328460	Frame MRK 201.5	
amount	36	
load carrier	euro palle	
packaging method	2 wide, 20 up	
packaging aid	steel strap, square timber	
328470	Frame MRK 230	
amount	36	
load carrier	euro palle	
packaging method	2 wide, 20 up	
packaging aid	steel strap, square timber	
328480	Frame MRK 237	
amount	36	
load carrier	euro palle	
packaging method	2 wide, 20 up	
packaging aid	steel strap, square timber	
328490	Frame MRK 266	
amount	36	
load carrier	euro palle	
packaging method	2 wide, 20 up	
packaging aid	steel strap, square timber	
328550	Tension Strap GT24, 22-31, galv.	
amount	300	
load carrier	hardware box	
packaging method	30 bundle, 10 per bundle	
packaging aid	steel strap, wooden cover plate	
328570	Crane Lifting Unit, Upper Part	
amount	200	
load carrier	wire crate k	
packaging method	loose	
packaging aid	steel strap, wooden cover plate	
328590	Tension Strap 16-25, galv.	
amount	300	
load carrier	hardware box	
packaging method	30 bundles, 10 per bundle	
packaging aid	steel strap, wooden cover plate	

Article No.	Article Name	Article Image
328660	Clawhead 16/20 S, galv.	
amount	300	
load carrier	wire crate k	
packaging method	loose	
packaging aid	steel strap, wooden cover plate	
328670	Clawhead 16/20, galv.	
amount	300	
load carrier	wire crate k	
packaging method	loose	
packaging aid	steel strap, wooden cover plate	
328680	Crosshead 20/24 S, galv.	
amount	75	
load carrier	wire crate k	
packaging method	stacked	
packaging aid	steel strap, wooden cover plate	
328690	Crosshead 16 s, galv.	
amount	100	
load carrier	wire crate k	
packaging method	4 layers, 5 x 5 per layer	
packaging aid	steel strap, wooden cover plate	
328700	Crosshead 16, galv.	
amount	100	
load carrier	wire crate k	
packaging method	4 layers, 5 x 5 per layer	
packaging aid	steel strap, wooden cover plate	
328710	Table Trolley 2 t, l = 2.00 m	
amount	1	
load carrier	loose	
packaging method	stacked	
packaging aid		
328715	Table Trolley 2 t, l = 1.70 m	
amount	1	
load carrier	loose	
packaging method	stacked	
packaging aid		

Article No.	Article Name	Article Image
328720	Attachment 100 for Table Trolley	
amount	4	
load carrier	post pallet RP 120	
packaging method	stacked	
packaging aid	steel strap	
328730	Prop PEP 20 N 260	
amount	42	
load carrier	post pallet RP 120	
packaging method	stacked	
packaging aid	steel strap	
328740	Prop PEP 20 N 300	
amount	42	
load carrier	post pallet RP 150	
packaging method	stacked	
packaging aid	steel strap	
328750	Prop PEP 20 N 350	
amount	42	
load carrier	post pallet RP 150	
packaging method	stacked	
packaging aid	steel strap	
328760	Prop PEP 20 G 410	
amount	30	
load carrier	post pallet RP 150	
packaging method	6 wide, 5 up	
packaging aid	steel strap	
328770	Slab Prop PEP 30 G 300	
amount	30	
load carrier	post pallet RP 150	
packaging method	stacked	
packaging aid	steel strap	
328780	Slab Prop PEP 30 G 350	
amount	30	
load carrier	post pallet RP 150	
packaging method	stacked	
packaging aid	steel strap	

Article No.	Article Name	Article Image
328790	Beam Waler UZR 190/150	
amount	9	
load carrier	post pallet RP 150	
packaging method	stacked	
packaging aid	steel strap, wooden strip between each layer	
328870	Lowering Head 20/24, galv.	
amount	80	
load carrier	wire crate k	
packaging method	stacked	
packaging aid	steel strap, wooden cover plate	
328880	Clawhead 24, galv.	
amount	200	
load carrier	wire crate k	
packaging method	loose	
packaging aid	steel strap, wooden cover plate	
328890	Clawhead 24 S, galv.	
amount	200	
load carrier	wire crate k	
packaging method	loose	
packaging aid	steel strap, wooden cover plate	
379300	Alu Beam MPB 24 L=3.00m	
amount	25	
load carrier	bundle	
packaging method	5 wide, 5 up	
packaging aid	steel strap	
379360	Alu Beam MPB 24 L=3.60m	
amount	25	
load carrier	bundle	
packaging method	5 wide, 5 up	
packaging aid	steel strap	
379420	Alu Beam MPB 24 L=4.20m	
amount	25	
load carrier	bundle	
packaging method	5 wide, 5 up	
packaging aid	steel strap	

Article No.	Article Name	Article Image
379480	Alu Beam MPB 24 L=4.80m	
amount	25	
load carrier	bundle	
packaging method	5 wide, 5 up	
packaging aid	steel strap	
379540	Alu Beam MPB 24 L=5.40m	
amount	25	
load carrier	bundle	
packaging method	5 wide, 5 up	
packaging aid	steel strap	
379600	Alu Beam MPB 24 L=6.00m	
amount	25	
load carrier	bundle	
packaging method	5 wide, 5 up	
packaging aid	steel strap	
401854	Central cross 170	
amount	10	
load carrier	euro pallet	
packaging method	stacked	
packaging aid	steel strap	
402251	Central cross 200	
amount	10	
load carrier	euro pallet	
packaging method	stacked	
packaging aid	steel strap	
403058	Slab Prop PEP 20-300, galv.	
amount	42	
load carrier	post pallet RP 120	
packaging method	stacked	
packaging aid	steel strap	
403059	Slab Prop PEP 20-350, galv.	
amount	42	
load carrier	post pallet RP 150	
packaging method	stacked	
packaging aid	steel strap	

Article No.	Article Name	Article Image
403060	Slab Prop PEP 20-400, galv.	
amount	42	
load carrier	post pallet RP 150	
packaging method	stacked	
packaging aid	steel strap	
403061	Slab Prop PEP 20-500, galv.	
amount	30	
load carrier	post pallet RP 150	
packaging method	stacked	
403062	Slab Prop PEP 30-300, galv.	
amount	42	
load carrier	post pallet RP 120	
packaging method	stacked	
403063	Slab Prop PEP 30-350, galv.	
amount	42	
load carrier	post pallet RP 150	
packaging method	stacked	
403065	Slab Prop PEP 30-400, galv.	
amount	30	
load carrier	post pallet RP 150	
packaging method	stacked	
403066	Slab Prop PEP 30-150, galv.	
amount	60	
load carrier	wire crate k	
packaging method	stacked	
403067	Slab Prop PEP 30-250, galv.	
amount	42	
load carrier	post pallet RP 120	
packaging method	stacked	
packaging aid	steel strap	







Article No.	Article Name	Article Image
404050	Extension 60 for Table Trolley	
amount	30	
load carrier	wire crate k	
packaging method	stacked	
packaging aid	steel strap, wooden cover plate	
406429	Slab Prop PEP 10-400 A, galv.	
amount	48	
load carrier	post pallet RP 120	
packaging method	8 wide, 6 up	
packaging aid	steel strap, square timber	
406432	Slab Prop PEP 10-350 A, galv.	
amount	48	
load carrier	post pallet RP 120	
packaging method	8 wide, 6 up	
packaging aid	steel strap, square timber	
406433	Slab Prop PEP 10-300 A, galv.	
amount	48	
load carrier	post pallet RP 120	
packaging method	8 wide, 6 up	
packaging aid	steel strap, square timber	
406434	Slab Prop PEP 10-250 A, galv.	
amount	48	
load carrier	post pallet RP 120	
packaging method	8 wide, 6 up	
packaging aid	steel strap, square timber	
407152	Tripod PEP Ergo, galv.	
amount	25	
load carrier	wire crate k	
packaging method	stacked	
packaging aid	steel strap, wooden cover plate	
407160	Connector MP-SRU	
amount	150	
load carrier	wire crate k	
packaging method	stacked	
packaging aid	steel strap, wooden plate between each layer, wooden cover plate	

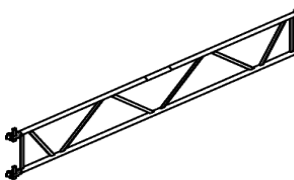
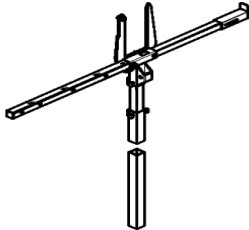

Article No.	Article Name	Article Image
407161	Compression Brace Head MP/SRU	
amount	300	
load carrier	wire crate k	
packaging method	stacked	
packaging aid	steel strap, wooden plate between each layer, wooden cover plate	
407169	MULTIPROP Platform 150 x 60	
amount	24	
load carrier	bundle	
packaging method	2 wide, 12 up	
packaging aid	steel strap, square timber, dunnage	
407170	MULTIPROP Platform 225 x 60	
amount	24	
load carrier	bundle	
packaging method	2 wide, 12 up	
packaging aid	steel strap, square timber, dunnage	
407171	MULTIPROP Platform 150 x 60 with Hatch	
amount	24	
load carrier	bundle	
packaging method	2 wide, 12 up	
packaging aid	steel strap, square timber, dunnage	
407172	MULTIPROP Platform 225 x 60 with Hatch	
amount	24	
load carrier	bundle	
packaging method	2 wide, 12 up	
packaging aid	steel strap, square timber, dunnage	
407173	Ladder 220 x 350, telescopic	
amount	7	
load carrier	post pallet RP 150	
packaging method	stacked	
packaging aid	steel strap	
407348	Coupling MPB 24	
amount	96	
load carrier	wire crate k	
packaging method	loose	
packaging aid	steel strap, wooden cover plate	

Article No.	Article Name	Article Image
408213	Brace Connector MPB 24	
amount	120	
load carrier	wire crate k	
packaging method	stacked	
packaging aid	steel strap, wooden cover plate	
411142	MULTIPROP Bolt with Nut	
amount	6000	
load carrier	hardware box	
packaging method	60 bags, 100 per bag	
packaging aid	steel strap, wooden cover plate	
411811	PEP Frames PRK 62.5	
amount	18	
load carrier	wire crate k	
packaging method	2 wide, 9 up	
packaging aid	steel strap, wooden cover plate	
411812	PEP Frames PRK 75	
amount	18	
load carrier	wire crate k	
packaging method	2 wide, 8 up crosswise + 2 standing	
packaging aid	steel strap	
411813	PEP Frames PRK 137.5	
amount	22	
load carrier	euro pallet	
packaging method	2 wide, 11 up	
packaging aid	steel strap	
411814	PEP Frames PRK 150	
amount	22	
load carrier	euro pallet	
packaging method	2 wide, 11 up	
packaging aid	steel strap	
411815	PEP Frames PRK 201.5	
amount	22	
load carrier	bundle	
packaging method	2 wide, 11 up	
packaging aid	steel strap, dunnage	

Article No.	Article Name	Article Image
411816	PEP Frames PRK 225	
amount	22	
load carrier	bundle	
packaging method	2 wide, 11 up	
packaging aid	steel strap, dunnage	
411817	PEP Frames PRK 230	
amount	22	
load carrier	bundle	
packaging method	2 wide, 11 up	
packaging aid	steel strap, dunnage	
411818	PEP Frames PRK 266	
amount	22	
load carrier	bundle	
packaging method	2 wide, 11 up	
packaging aid	steel strap, dunnage	
411819	PEP Frames PRK 296	
amount	22	
load carrier	bundle	
packaging method	2 wide, 11 up	
packaging aid	steel strap, dunnage	
412718	PEP Frames PRK 200	
amount	22	
load carrier	bundle	
packaging method	2 wide, 11 up	
packaging aid	steel strap	
412719	Frame MRK 210	
amount	40	
load carrier	bundle	
packaging method	2 wide, 20 up	
packaging aid	steel strap, dunnage	
412788	PEP Frames PRK 210	
amount	22	
load carrier	bundle	
packaging method	2 wide, 11 up	
packaging aid	steel strap, dunnage	



Article No.	Article Name	Article Image
412813	PEP Frames PRK 100	
amount	22	
load carrier	euro pallet	
packaging method	2 wide, 11 up	
packaging aid	steel strap	
412814	PEP Frames PRK 120	
amount	22	
load carrier	euro pallet	
packaging method	2 wide, 11 up	
packaging aid	steel strap	
416596	Flexclip VT/VT	
amount	200	
load carrier	hardware box	
packaging method	loose	
packaging aid	steel strap, wooden cover plate	
416605	Flexclip GT/VT	
amount	200	
load carrier	hardware box	
packaging method	loose	
packaging aid	steel strap, wooden cover plate	
416614	Flexclip GT/GT	
amount	200	
load carrier	hardware box	
packaging method	loose	
packaging aid	steel strap, wooden cover plate	
416770	Slab Prop PEP Ergo D-250	
amount	42	
load carrier	post pallet RP 120	
packaging method	stacked	
packaging aid	steel strap	
416780	Slab Prop PEP Ergo B-300	
amount	36	
load carrier	post pallet RP 120	
packaging method	stacked	
packaging aid	steel strap	

Article No.	Article Name	Article Image
416790	Slab Prop PEP Ergo B-350	
amount	36	
load carrier	post pallet RP 120	
packaging method	stacked	
packaging aid	steel strap	
417230	Slab Prop PEP Ergo D-150	
amount	60	
load carrier	wire crate k	
packaging method	stacked	
packaging aid	steel strap	
417358	Frame MRK 350	
amount	40	
load carrier	bundle	
packaging method	2 wide, 20 up	
packaging aid	steel strap, square timber, dunnage	
417574	Distance Device MF-Plus	
amount	1	
load carrier	loose	
packaging method	loose	
packaging aid		
417575	Fixing Tool MF, galv.	
amount	1	
load carrier	loose	
packaging method	loose	
packaging aid		
425130	Slab Prop PEP Ergo D-350	
amount	36	
load carrier	post pallet RP 120	
packaging method	stacked	
packaging aid	steel strap	
425140	Slab Prop PEP Ergo D-400	
amount	36	
load carrier	post pallet RP 120	
packaging method	stacked	
packaging aid	steel strap	

Article No.	Article Name	Article Image
425150	Slab Prop PEP Ergo D-500	
amount	30	
load carrier	post pallet RP 120	
packaging method	stacked	
packaging aid	steel strap	
425160	Slab Prop PEP Ergo E-300	
amount	36	
load carrier	post pallet RP 120	
packaging method	stacked	
packaging aid	steel strap	
425170	Slab Prop PEP Ergo E-400	
amount	36	
load carrier	post pallet RP 120	
packaging method	stacked	
packaging aid	steel strap	
430272	PROP PEP ALPHA D-300	
amount	42	
load carrier	post pallet RP 120	
packaging method	7 wide, 6 up	
packaging aid	steel strap	
430274	PROP PEP ALPHA D-350	
amount	42	
load carrier	post pallet RP 120	
packaging method	7 wide, 6 up	
packaging aid	steel strap	
431085	Slab Prop PEP Ergo E-350 +	
amount	35	
load carrier	post pallet RP 120	
packaging method	stacked	
packaging aid	steel strap	
431104	Slab Prop PEP Ergo E-300 +	
amount	35	
load carrier	post pallet RP 120	
packaging method	stacked	
packaging aid	steel strap	

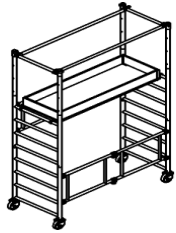
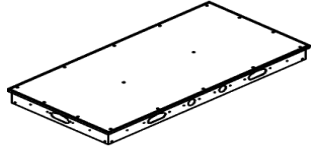
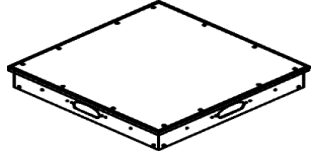
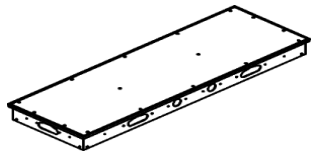
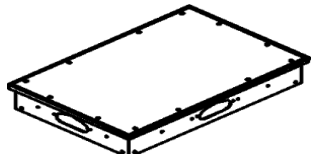
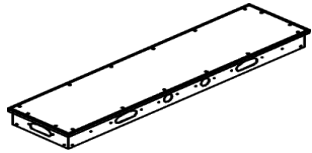
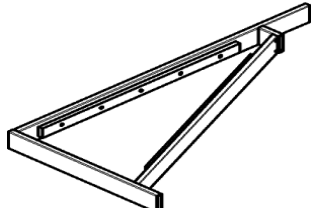

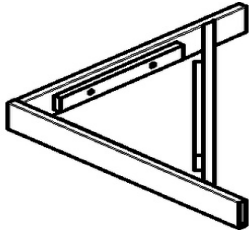
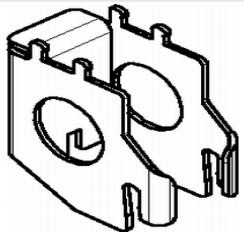

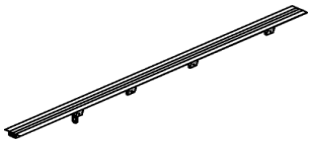
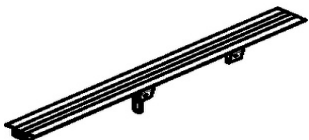
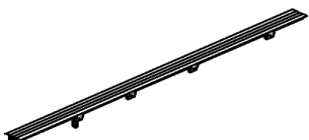
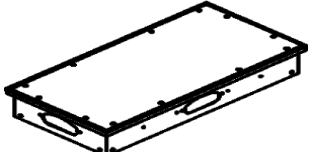
Article No.	Article Name	Article Image
431111	Slab Prop PEP Ergo D-350 +	
amount	42	
load carrier	post pallet RP 120	
packaging method	stacked	
packaging aid	steel strap	
431360	Slab Prop PEP Ergo D-300 +	
amount	42	
load carrier	post pallet RP 120	
packaging method	stacked	
packaging aid	steel strap	

Article No.	Article Name	Article Image
335500	Stripping Cart, Alu	
amount	1	
load carrier	euro pallet	
packaging method	loose	
packaging aid	steel strap	
361000	Panel SDP 150 x 75	
amount	14 or 48	
load carrier	SD-pallet or SD-big pallet	
packaging method	stacked	
packaging aid	5 tension straps	
361010	Panel SDP 75 x 75	
amount	28	
load carrier	SD-pallet	
packaging method	2 wide, 14 up	
packaging aid	steel strap	
361011	Panel SDP 150 x 50	
amount	20	
load carrier	SD-pallet	
packaging method	14 up + 2 x 3 crosswise	
packaging aid	steel strap	
361013	Panel SDP 75 x 50	
amount	42	
load carrier	SD-pallet	
packaging method	3 wide, 14 up	
packaging aid	steel strap	
361020	Panel SDP 150 x 37.5	
amount	28	
load carrier	SD-pallet	
packaging method	2 wide, 14 up	
packaging aid	steel strap	
361021	Triangular Frame SDR 150 x 75	
amount	12	
load carrier	post pallet RP 120	
packaging method	stacked	
packaging aid	steel strap	

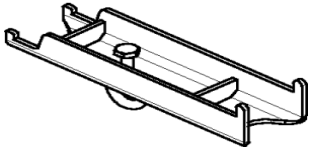
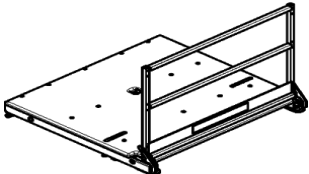
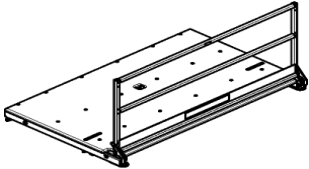
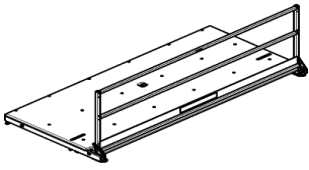
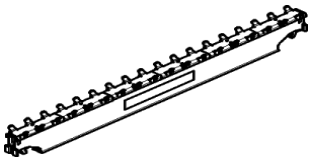
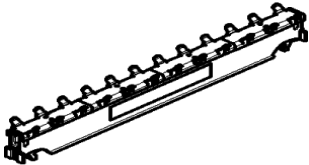
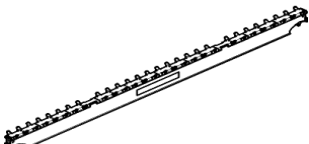

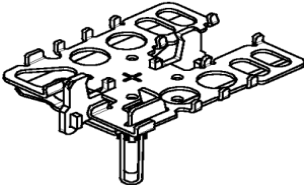
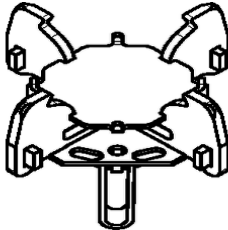
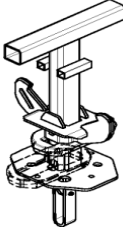
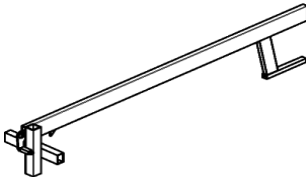
Article No.	Article Name	Article Image
361022	Triangular Frame SDR 75 x 75	
amount	24	
load carrier	wire crate k	
packaging method	stacked	
packaging aid	steel strap, wooden cover plate	
361023	End Support SSL	
amount	260	
load carrier	wire crate k	
packaging method	stacked	
packaging aid	steel strap	
361024	Cover Strip SAL 50	
amount	532	
load carrier	wire crate k	
packaging method	stacked	
packaging aid	steel strap, wooden cover plate	
361026	Cover Strip SAL 150	
amount	120	
load carrier	post pallet RP 120	
packaging method	stacked	
packaging aid	steel strap	
361027	Cover Strip SAL 75	
amount	380	
load carrier	wire crate k	
packaging method	stacked	
packaging aid	steel strap, wooden cover plate	
361028	COVER STRIP SAL 150/27	
amount	100	
load carrier	post pallet RP 120	
packaging method	10 wide, 10 up	
packaging aid	steel strap, wooden cover plate	
361030	Panel SDP 75 x 37.5	
amount	56	
load carrier	SD-pallet	
packaging method	4 wide, 14 up	
packaging aid	steel strap	

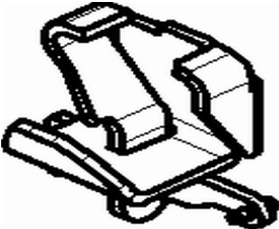
Article No.	Article Name	Article Image
361036	Filler Timber SPH 225	
amount	54	
load carrier	post pallet RP 150	
packaging method	6 wide, 9 up	
packaging aid	steel strap	
361038	Cover Strip SAL 37.5	
amount	760	
load carrier	wire crate k	
packaging method	stacked	
packaging aid	steel strap, wooden cover plate	
361041	Grid Beam SRO 150	
amount	48	
load carrier	post pallet RP 150	
packaging method	8 wide, 6 up	
packaging aid	steel strap	
361045	Edge Beam SRT-2 150	
amount	78	
load carrier	post pallet RP 120	
packaging method	nailing bar on bottom	
packaging aid	steel strap	
361046	Edge Beam SRT-2 75	
amount	192	
load carrier	wire crate k	
packaging method	24 breit, 8 hoch / nailing bar on bottom	
packaging aid	steel strap, wooden cover plate	
361049	Filler Timber SPH 150	
amount	54	
load carrier	post pallet RP 120	
packaging method	6 wide, 9 up	
packaging aid	steel strap	
361051	Wall Holder SWH-2	
amount	24	
load carrier	post pallet RP 120	
packaging method	6 wide, 4 up	
packaging aid	steel strap	

Article No.	Article Name	Article Image
361052	Table Connector STV	
amount	200	
load carrier	hardware box	
packaging method	loose	
packaging aid	steel strap, wooden cover plate	
361060	Platform SDB 150	
amount	1	
load carrier	loose	
packaging method	stacked	
packaging aid	steel strap	
361061	Platform SDB 225	
amount	1	
load carrier	loose	
packaging method	stacked	
packaging aid	steel strap	
361062	Platform SDB 300	
amount	1	
load carrier	loose	
packaging method	stacked	
packaging aid	steel strap	
361100	Main Beam SLT 225	
amount	15	
load carrier	post pallet RP 150	
packaging method	3 wide lying, 10 up	
packaging aid	steel strap, square timber	
361110	Main Beam SLT 150	
amount	21	
load carrier	post pallet RP 120	
packaging method	7 wide upright, 3 up	
packaging aid	steel strap	
361160	Main Beam SLT 375	
amount	30	
load carrier	post pallet USP 104	
packaging method	3 wide lying, 10 up	
packaging aid	steel strap	

Article No.	Article Name	Article Image
361180	Combihead SCK	
amount	80	
load carrier	wire crate k	
packaging method	loose	
packaging aid	steel strap, wooden cover plate	
361200	Prophead SSK	
amount	150	
load carrier	wire crate k	
packaging method	loose	
packaging aid	steel strap, wooden cover plate	
361210	Drophead SFK	
amount	75	
load carrier	wire crate k	
packaging method	loose	
packaging aid	steel strap, wooden cover plate	
361250	Guardrail Holder SGH, Alu	
amount	30	
load carrier	post pallet RP 120	
packaging method	stacked	
packaging aid	steel strap	
361260	Guardrail Post SGP	
amount	100	
load carrier	post pallet RP 120	
packaging method	16 wide, 6 up + 4	
packaging aid	steel strap	
361280	Panel Wedge Clip SPKK	
amount	500	
load carrier	hardware box	
packaging method	loose	
packaging aid	steel strap, wooden cover plate	
361290	Panel Clip SPK	
amount	1000	
load carrier	hardware box	
packaging method	20 bags, 50 per bag	
packaging aid	steel strap, wooden cover plate	

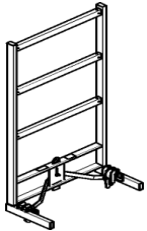
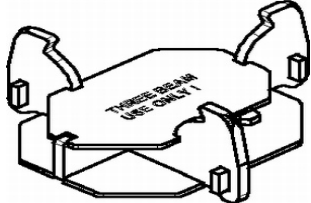
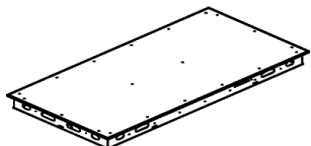
Article No.	Article Name	Article Image
361300	Erection Aid SSH	
amount	1	
load carrier	loose	
packaging method	loose	
packaging aid		
361310	Tension Sleeve SAO	
amount	300	
load carrier	hardware box	
packaging method	loose	
packaging aid	steel strap, wooden cover plate	
361510	Pallet Lifting Trolley 1800 mm	
amount	1	
load carrier	loose	
packaging method	loose	
packaging aid		
361520	Transportation Fork SUG, galv.	
amount	1	
load carrier	loose	
packaging method	loose	
packaging aid	boom dismantled	
402031	Stripping Cart ASW 465, compl.	
amount	1	
load carrier	post pallet USP 104	
packaging method	loose	
packaging aid	steel strap	
414755	Boom Lift 290	
amount	1	
load carrier	loose	
packaging method	loose	
packaging aid		
418323	Handrail Unit SD 150	
amount	10	
load carrier	pallet handrail unit SD 150	
packaging method	stacked	
packaging aid		

Article No.	Article Name	Article Image
418331	Handrail Unit SD 75	
amount	10	
load carrier	pallet handrail unit SD 75	
packaging method	stacked	
packaging aid		
418622	Transition Prophead SDKS	
amount	100	
load carrier	wire crate k	
packaging method	stacked	
packaging aid	steel strap, wooden cover plate	
433343	EYELET CONNECTOR SXP EC	
amount	420	
load carrier	hardware box	
packaging method	stacked	
packaging aid	steel strap, wooden cover plate	
433358	CONNECTOR SXP CO	
amount	385	
load carrier	hardware box	
packaging method	stacked	
packaging aid	steel strap, wooden cover plate	
433381	PANEL SXP P 200X66,5 ALU	
amount	39	
load carrier	TRANSP. PALETT SXP TP 200X200	
packaging method	3 wide, 13 high	
packaging aid	tension belt	
433382	PANEL SXP P 200X100 ALU	
amount	26	
load carrier	TRANSP. PALETT SXP TP 200X200	
packaging method	2 wide, 13 high	
packaging aid	tension belt	
433701	SUPPORT HEAD SXP S	
amount	220	
load carrier	wire crate k	
packaging method	stacked	
packaging aid	steel strap, wooden cover plate	

Article No.	Article Name	Article Image
433934	WALL HOLDER SXP W	
amount	35	
load carrier	post pallet RP 120	
packaging method	7 wide, 5 high	
packaging aid	steel strap, square timber	
434194	STARTTRAEGER SXP SB 300	
amount	18	
load carrier	post pallet RP 150	
packaging method	6 wide, 3 high	
packaging aid	steel strap, square timber	
434202	STARTER BEAM SXP SB 66,5	
amount	63	
load carrier	wire crate k	
packaging method	stacked	
packaging aid	steel strap, wooden cover plate	
434203	STARTTRAEGER SXP SB 100	
amount	35	
load carrier	wire crate k	
packaging method	stacked	
packaging aid	steel strap, wooden cover plate	
435069	FRAME SXP GU 100	
amount	4	
load carrier	post pallet RP 150	
packaging method	stacked	
packaging aid	steel strap, square timber	
435129	TRAVERSE SXP GU 100	
amount	58	
load carrier	wire crate k	
packaging method	stacked	
packaging aid	steel strap, wooden cover plate	
435132	PLUG GUARDRAIL SXP GU 100	
amount	12	
load carrier	post pallet RP 120	
packaging method	stacked	
packaging aid	steel strap	

Article No.	Article Name	Article Image
435178	PANEL ADP 180X120	
amount	12	
load carrier	PALLET AD 180 (135719)	
packaging method	stacked	
packaging aid	tension belt	
435243	PANEL ADP 240X120	
amount	12	
load carrier	PALLET AD 240 (135314)	
packaging method	stacked	
packaging aid	tension belt	
435244	BRACE ADB 120	
amount	10	
load carrier	bundle	
packaging method	stacked	
packaging aid	steel strap, square timber	
435245	BRACE ADB 180	
amount	10	
load carrier	bundle	
packaging method	stacked	
packaging aid	steel strap, square timber	
435246	BRACE ADB 240	
amount	10	
load carrier	bundle	
packaging method	stacked	
packaging aid	steel strap, square timber	
435605	GUARDRAIL POST HOLDER ADG	
amount	80	
load carrier	wire crate k	
packaging method	stacked	
packaging aid	steel strap, wooden cover plate	
435653	CROSSHEAD ADC	
amount	108	
load carrier	wire crate k	
packaging method	stacked	
packaging aid	steel strap, wooden cover plate	

Article No.	Article Name	Article Image
435667	FILLER BEAM ADF 120	
amount	36	
load carrier	post pallet RP 120	
packaging method	9 wide, 4 up	
packaging aid	steel strap, square timber	
435671	FILLER BEAM ADF 180	
amount	24	
load carrier	post pallet RP 150	
packaging method	8 wide, 3 up	
packaging aid	steel strap, square timber	
435675	FILLER BEAM ADF 240	
amount	24	
load carrier	post pallet RP 150	
packaging method	8 wide, 3 up	
packaging aid	steel strap, square timber	
435685	CROSS BEAM HEAD ADI	
amount	524	
load carrier	wire crate k	
packaging method	stacked	
packaging aid	steel strap, wooden cover plate	
436765	TENSION UNIT SXP TU 3 100 T2	
amount	38	
load carrier	hardware box	
packaging method	stacked	
packaging aid	steel strap, wooden cover plate	
436769	TENSION UNIT SXP TU 3 66,5 T2	
amount	51	
load carrier	hardware box	
packaging method	stacked	
packaging aid	steel strap, wooden cover plate	
437260	PANEL SXP P 100X100 ALU	
amount	6	
load carrier	Euro pallet	
packaging method	6 high	
packaging aid	steel strap	

Article No.	Article Name	Article Image
345010	Circular Column Panel Ø 25 cm, h = 0.3 m	
amount	12	
load carrier	wire crate k	
packaging method	4 wide, 3 up	
packaging aid	steel strap, wooden cover plate	
345011	Circular Column Panel Ø 25 cm, h = 1.2 m	
amount	6	
load carrier	post pallet RP 150	
packaging method	2 wide, 3 up	
packaging aid	steel strap	
345012	Circular Column Panel Ø 25 cm, h = 2.4 m	
amount	3	
load carrier	post pallet RP 150	
packaging method	stacked	
packaging aid	steel strap	
345013	Circular Column Panel Ø 25 cm, h = 3.0 m	
amount	3	
load carrier	post pallet RP 150	
packaging method	stacked	
packaging aid	steel strap	
345020	Circular Column Panel Ø 30 cm, h = 0.3 m	
amount	12	
load carrier	wire crate k	
packaging method	4 wide, 3 up	
packaging aid	steel strap, wooden cover plate	
345021	Circular Column Panel Ø 30 cm, h = 1.2 m	
amount	6	
load carrier	post pallet RP 150	
packaging method	2 wide, 3 up	
packaging aid	steel strap	
345022	Circular Column Panel Ø 30 cm, h = 2.4 m	
amount	3	
load carrier	post pallet RP 150	
packaging method	stacked	
packaging aid	steel strap	



Article No.	Article Name	Article Image
345023	Circular Column Panel Ø 30 cm, h = 3.0 m	
amount	3	
load carrier	post pallet RP 150	
packaging method	stacked	
packaging aid	steel strap	
345030	Circular Column Panel Ø 35 cm, h = 0.3 m	
amount	12	
load carrier	wire crate k	
packaging method	4 wide, 3 up	
packaging aid	steel strap, wooden cover plate	
345031	Circular Column Panel Ø 35 cm, h = 1.2 m	
amount	8	
load carrier	post pallet USP 72	
packaging method	2 wide, 4 up	
packaging aid	steel strap	
345032	Circular Column Panel Ø 35 cm, h = 2.4 m	
amount	3	
load carrier	post pallet RP 150	
packaging method	stacked	
packaging aid	steel strap	
345033	Circular Column Panel Ø 35 cm, h = 3.0 m	
amount	3	
load carrier	post pallet RP 150	
packaging method	stacked	
packaging aid	steel strap	
345040	Circular Column Panel Ø 40 cm, h = 0.3 m	
amount	9	
load carrier	wire crate k	
packaging method	stacked	
packaging aid	steel strap, wooden cover plate	
345041	Circular Column Panel Ø 40 cm, h = 1.2 m	
amount	4	
load carrier	post pallet USP 72	
packaging method	stacked	
packaging aid	steel strap	

Article No.	Article Name	Article Image
345042	Circular Column Panel Ø 40 cm, h = 2.4 m	
amount	3	
load carrier	post pallet RP 150	
packaging method	stacked	
packaging aid	steel strap	
345043	Circular Column Panel Ø 40 cm, h = 3.0 m	
amount	3	
load carrier	post pallet RP 150	
packaging method	stacked	
packaging aid	steel strap	
345050	Circular Column Panel Ø 45 cm, h = 0.3 m	
amount	9	
load carrier	wire crate k	
packaging method	stacked	
packaging aid	steel strap, wooden cover plate	
345051	Circular Column Panel Ø 45 cm, h = 1.2 m	
amount	3	
load carrier	post pallet USP 72	
packaging method	stacked	
packaging aid	steel strap	
345052	Circular Column Panel Ø 45 cm, h = 2.4 m	
amount	3	
load carrier	post pallet USP 72	
packaging method	stacked	
packaging aid	steel strap	
345053	Circular Column Panel Ø 45 cm, h = 3.0 m	
amount	3	
load carrier	post pallet USP 72	
packaging method	stacked	
packaging aid	steel strap	
345060	Circular Column Panel Ø 50 cm, h = 0.3 m	
amount	6	
load carrier	wire crate k	
packaging method	stacked	
packaging aid	steel strap, wooden cover plate	

Article No.	Article Name	Article Image
345061	Circular Column Panel Ø 50 cm, h = 1.2 m	
amount	3	
load carrier	post pallet USP 72	
packaging method	stacked	
packaging aid	steel strap	
345062	Circular Column Panel Ø 50 cm, h = 2.4 m	
amount	3	
load carrier	post pallet USP 72	
packaging method	stacked	
packaging aid	steel strap	
345063	Circular Column Panel Ø 50 cm, h = 3.0 m	
amount	3	
load carrier	post pallet USP 72	
packaging method	stacked	
packaging aid	steel strap	
345080	Circular Column Panel Ø 60 cm h = 0,3 m	
amount	4	
load carrier	wire crate k	
packaging method	stacked	
packaging aid	steels strap	
345090	Circular Column Panel Ø 65 cm h = 0,3 m	
amount	4	
load carrier	wire crate k	
packaging method	stacked	
packaging aid	steel strap	
345100	Circular Column Panel Ø 70 cm h = 0,3 m	
amount	4	
load carrier	wire crate k	
packaging method	stacked	
packaging aid	steel strap	
345200	Adapter Strip SRS-TRIO, l = 3.00 m	
amount	1	
load carrier	loose	
packaging method	stacked	
packaging aid		

Article No.	Article Name	Article Image
345210	Circular Column Platform 25 – 70, compl.	
amount	1	
load carrier	euro pallet	
packaging method	bundeled	
packaging aid	steel strap	
402177	Circular Column Platform 75-120, compl.	
amount	1	
load carrier	euro pallet	
packaging method	loose	
packaging aid	steel strap	
403374	Ladder Connector SRS, galv.	
amount	30	
load carrier	wire crate k	
packaging method	stacked, shifted	
packaging aid	steel strap, wooden cover plate	
403417	Exit Handrail Post SRS 134, galv.	
amount	14	
load carrier	post pallet RP 150	
packaging method	stacked	
packaging aid	steel strap	
403718	Ladder Hook, galv.	
amount	300	
load carrier	hardware box	
packaging method	loose	
packaging aid	steel strap, wooden cover plate	
403724	End Ladder 180/2, galv.	
amount	18	
load carrier	post pallet RP 150	
packaging method	13 up + 5	
packaging aid	steel strap	
404196	SRS Ladder Holder	
amount	500	
load carrier	hardware box	
packaging method	loose	
packaging aid	steel strap, wooden cover plate	

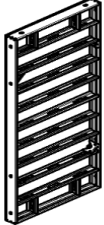
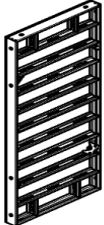
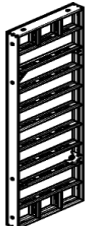
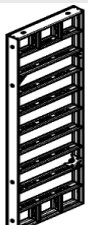
Article No.	Article Name	Article Image
366000	Panel D 300 x 100	
amount	8	
load carrier	stacking device Domino	
packaging method	stacked	
packaging aid	steel strap, stacking device	
366002	Panel D 300 x 75	
amount	8	
load carrier	stacking device Domino	
packaging method	stacked	
packaging aid	steel strap, stacking device	
366004	Multi Panel DM 300 x 75	
amount	8	
load carrier	stacking device Domino	
packaging method	stacked	
packaging aid	steel strap, stacking device	
366005	Panel D 300 x 50	
amount	8	
load carrier	stacking device Domino	
packaging method	stacked	
packaging aid	steel strap, stacking device	
366006	Panel D 300 x 25	
amount	32	
load carrier	bundle	
packaging method	4 wide, 8 up	
packaging aid	steel strap, stacking device	
366008	External Corner DAW 300	
amount	40	
load carrier	post pallet RP 150	
packaging method	stacked	
packaging aid	steel strap	
366009	Articulated Corner DGE 300	
amount	6	
load carrier	post pallet RP 120	
packaging method	stacked	
packaging aid	steel strap	

Article No.	Article Name	Article Image
366010	Wall Thickness Compensation DWD 300 x 5	
amount	40	
load carrier	post pallet RP 150	
packaging method	stacked	
packaging aid	steel strap, wooden strip between each layer	
366020	Panel D 250 x 100	
amount	8	
load carrier	stacking device Domino	
packaging method	stacked	
packaging aid	1 x steel strap around bundle, 1 x steel strap horizontal around stacking device	
366021	Panel DA 250 x 100	
amount	8	
load carrier	stacking device Domino	
packaging method	stacked	
packaging aid	1 x steel strap around bundle, 1 x steel strap horizontal around stacking device	
366022	Panel D 250 x 75	
amount	8	
load carrier	stacking device Domino	
packaging method	stacked	
packaging aid	steel strap, stacking device	
366023	Panel DA 250 x 75	
amount	8	
load carrier	stacking device Domino	
packaging method	stacked	
packaging aid	1 x steel strap around bundle, 1 x steel strap horizontal around stacking device	
366024	Multi Panel DM 250 x 75	
amount	8	
load carrier	stacking device Domino	
packaging method	stacked	
packaging aid	1 x steel strap around bundle, 1 x steel strap horizontal around stacking device	
366025	Panel D 250 x 50	
amount	16	
load carrier	bundle	
packaging method	2 wide, 8 up	
packaging aid	steel strap, dunnage	

Article No.	Article Name	Article Image
366026	Panel D 250 x 25	
amount	32	
load carrier	bundle	
packaging method	4 wide, 8 up	
packaging aid	steel strap, stacking device, dunnage	
366028	Outside Corner Angle DAW 250	
amount	40	
load carrier	post pallet RP 150	
packaging aid	steel strap	
366029	Articulated Corner DGE 250	
amount	6	
load carrier	post pallet RP 150	
packaging aid	steel strap, square timber	
366030	Wall Thickness Comp. DWD 250 x 5	
amount	40	
load carrier	post pallet RP 150	
packaging aid	steel strap, wooden strip between each layer	
366032	Multi Panel Alu DMA 250 x 75	
amount	8	
load carrier	stacking device Domino	
packaging aid	1 x steel strap around bundle, 1 x steel strap horizontal around stacking device	
366035	Column Panel DS 250 x 40	
amount	8	
load carrier	bundle	
packaging aid	steel strap, stacking device, dunnage	
366036	Panel DOMINO 250 x 35	
amount	32	
load carrier	bundle	
packaging aid	steel strap, square timber, dunnage	

Article No.	Article Name	Article Image
366040	Panel D 125 x 100	
amount	8	
load carrier	stacking device Domino	
packaging method	stacked	
packaging aid	1 x steel strap around bundle, 1 x steel strap horizontal around stacking device	
366041	Panel D 125 x 75	
amount	8	
load carrier	stacking device Domino	
packaging method	stacked	
packaging aid	1 x steel strap around bundle, 1 x steel strap horizontal around stacking device	
366042	Multi Panel DM 125 x 75	
amount	8	
load carrier	bundle	
packaging method	stacked	
packaging aid	steel strap, stacking device, dunnage	
366043	Panel D 125 x 50	
amount	16	
load carrier	bundle	
packaging method	2 wide, 8 up	
packaging aid	steel strap, stacking device, dunnage	
366044	Panel D 125 x 25	
amount	32	
load carrier	euro pallet	
packaging method	4 wide, 8 up	
packaging aid	steel strap	
366046	Outside Corner Angle DAW 125	
amount	40	
load carrier	post pallet RP 120	
packaging method	stacked	
packaging aid	steel strap	
366047	Articulated Corner DGE 125	
amount	6	
load carrier	post pallet RP 120	
packaging method	stacked	
packaging aid	steel strap	







Article No.	Article Name	Article Image
366048	Wall Thickness Comp. DWD 125 x 5	
amount	40	
load carrier	post pallet RP 120	
packaging method	stacked	
packaging aid	steel strap	
366050	Panel DA 125 x 100	
amount	8	
load carrier	stacking device Domino	
packaging method	stacked	
packaging aid	1 x steel strap around bundle, 1 x steel strap horizontal around stacking device	
366051	Panel DA 125 x 75	
amount	8	
load carrier	stacking device Domino	
packaging method	stacked	
packaging aid	1 x steel strap around bundle, 1 x steel strap horizontal around stacking device	
366052	Multi Panel DMA 125 x 75	
amount	8	
load carrier	bundle	
packaging method	stacked	
packaging aid	steel strap, stacking device, dunnage	
366055	DOMINO PANEL DS 125X 40	
amount	8	
load carrier	stacking device Domino	
packaging method	8 layers	
packaging aid	steel strap	
366060	Panel D 75 x 100	
amount	16	
load carrier	euro pallet	
packaging method	2 wide, 8 up	
packaging aid	steel strap, stacking device	
366061	Panel D 75 x 75	
amount	16	
load carrier	euro pallet	
packaging method	2 wide, 8 up	
packaging aid	steel strap, stacking device	

Article No.	Article Name	Article Image
366062	Multi Panel DM 75 x 75	
amount	16	
load carrier	euro pallet	
packaging method	2 wide, 8 up	
packaging aid	steel strap, stacking device	
366063	Panel D 75 x 50	
amount	16	
load carrier	euro pallet	
packaging method	2 wide, 8 up	
packaging aid	steel strap, stacking device	
366064	Panel D 75 x 25	
amount	32	
load carrier	euro pallet	
packaging method	4 wide, 8 up	
packaging aid	steel strap	
366066	Outside Corner Angle DAW 75	
amount	80	
load carrier	wire crate k	
packaging method	stacked	
packaging aid	steel strap, wooden cover plate	
366067	Articulated Corner DGE 75	
amount	14	
load carrier	wire crate k	
packaging method	upright	
packaging aid	steel strap, wooden cover plate	
366068	Wall Thickness Compensation DWD 75 x 5	
amount	100	
load carrier	wire crate k	
packaging method	stacked	
packaging aid	steel strap, wooden cover plate	
366071	DOMINO Panel D 75 x 35	
amount	32	
load carrier	euro pallet	
packaging method	4 wide, 8 up	
packaging aid	steel strap, square timber	





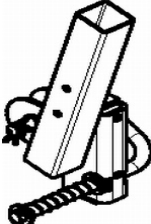

Article No.	Article Name	Article Image
366080	Alignment Coupler DRS	
amount	150	
load carrier	wire crate k	
packaging method	loose	
packaging aid	steel strap, wooden cover plate	
366081	Wedge Clamp DKS	
amount	600	
load carrier	wire crate k	
packaging method	loose	
packaging aid	steel strap, wooden cover plate	
366082	Brace Connector DRA	
amount	600	
load carrier	wire crate k	
packaging method	loose	
packaging aid	steel strap, wooden cover plate	
366083	Bulkhead Tie DOMINO DSA	
amount	800	
load carrier	wire crate k	
packaging method	loose	
packaging aid	steel strap, wooden cover plate	
366084	Compensation Waler DAR 80	
amount	80	
load carrier	wire crate k	
packaging method	stacked	
packaging aid	steel strap, wooden cover plate	
366085	Scaffold Bracket DG 85	
amount	35	
load carrier	wire crate k	
packaging method	stacked	
packaging aid	steel strap, wooden cover plate	
366086	Top Tie Bracket DAH	
amount	800	
load carrier	wire crate k	
packaging method	loose	
packaging aid	steel strap, wooden cover plate	

Article No.	Article Name	Article Image
366090	Foundation Tie Clamp DOMINO DLS	
amount	200	
load carrier	wire crate k	
packaging method	loose	
packaging aid	steel strap, wooden cover plate	
366091	Lifting Hook DOMINO 500 kg	
amount	150	
load carrier	wire crate k	
packaging method	loose	
packaging aid	steel strap, wooden cover plate	
366094	Stacking Device DOMINO DSR, galv.	
amount	50	
load carrier	wire crate k	
packaging method	stacked	
packaging aid	steel strap, wooden cover plate	
366095	Positioning DGE 135° internal	
amount	200	
load carrier	hardware box	
packaging method	loose	
packaging aid	steel strap, wooden cover plate	
366097	Positioning DGE 135° external	
amount	200	
load carrier	hardware box	
packaging method	loose	
packaging aid	steel strap, wooden cover plate	
366100	Positioning DEA 90°	
amount	100	
load carrier	hardware box	
packaging method	loose	
packaging aid	steel strap, wooden cover plate	
401927	Stopend Panel DOMINO AT 250 x 3	
amount	as required	
load carrier	post pallet RP 150	
packaging method	stacked	
packaging aid	steel strap	

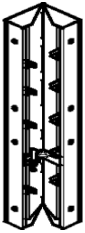
Article No.	Article Name	Article Image
401936	Stopend Panel DOMINO MTF 125 x 24/25	
amount	8	
load carrier	post pallet RP 120	
packaging method	stacked	
packaging aid	steel strap	
401937	Stopend Panel DOMINO MTF 125 x 30	
amount	8	
load carrier	post pallet RP 120	
packaging method	stacked	
packaging aid	steel strap	
401964	Wall Thickness Comp. DWD 125 x 10	
amount	24	
load carrier	post pallet RP 120	
packaging method	6 wide, 4 up	
packaging aid	steel strap	
401986	Wall Thickness Comp. DWD 250 x 10	
amount	24	
load carrier	post pallet RP 150	
packaging method	6 wide, 4 up	
packaging aid	steel strap	
405686	Panel D 275 x 25	
amount	32	
load carrier	bundle	
packaging method	4 wide, 8 up	
packaging aid	steel strap, stacking device	
405695	Panel D 275 x 50	
amount	8	
load carrier	stacking device Domino	
packaging method	stacked	
packaging aid	steel strap, stacking device	
405706	Panel D 275 x 75	
amount	8	
load carrier	stacking device Domino	
packaging method	stacked	
packaging aid	steel strap, stacking device	

Article No.	Article Name	Article Image
405708	Articulated Corner DGE 275	
amount	6	
load carrier	post pallet RP 120	
packaging method	stacked	
packaging aid	steel strap	
405724	Panel D 275 x 100	
amount	8	
load carrier	stacking device Domino	
packaging method	stacked	
packaging aid	steel strap, stacking device	
405734	Outside Corner Angle DAW 275	
amount	40	
load carrier	post pallet RP 150	
packaging method	stacked	
packaging aid	steel strap	
405735	Multi Panel DM 275 x 75	
amount	8	
load carrier	stacking device Domino	
packaging method	stacked	
packaging aid	steel strap, stacking device	
405740	Wall Thickness Compensation DWD 275 x 5	
amount	40	
load carrier	post pallet RP 150	
packaging method	stacked	
packaging aid	steel strap, wooden strip between each layer	
405746	Wall Thickness Compensation DWD 275 x 10	
amount	24	
load carrier	post pallet RP 120	
packaging method	6 wide, 4 up	
packaging aid	steel strap	
406877	Guardrail Post Holder DOMINO	
amount	120	
load carrier	wire crate k	
packaging method	stacked	
packaging aid	steel strap, wooden cover plate	

Article No.	Article Name	Article Image
411655	Shaft Panel DSE 125	
amount	4	
load carrier	post pallet RP 120	
packaging method	stacked	
packaging aid	steel strap	
424498	Panel D 150 x 100	
amount	8	
load carrier	stacking device Domino	
packaging method	stacked	
packaging aid	1 x steel strap around bundle, 1 x steel strap horizontal around stacking device	
424504	Panel D 150 x 75	
amount	8	
load carrier	stacking device Domino	
packaging method	stacked	
packaging aid	1 x steel strap around bundle, 1 x steel strap horizontal around stacking device	
424510	Panel D 150 x 50	
amount	16	
load carrier	bundle	
packaging method	8 layers, 2 per layer	
packaging aid	steel strap, square timber, dunnage	
424517	Panel D 150 x 35	
amount	24	
load carrier	euro pallet	
packaging method	3 per layer, 8 up	
packaging aid	steel strap	
424523	Panel D 150 x 25	
amount	32	
load carrier	euro pallet	
packaging method	4 wide, 8 up	
packaging aid	steel strap	
424538	Multi Panel DM 150 x 75	
amount	8	
load carrier	stacking device Domino	
packaging method	stacked	
packaging aid	1 x steel strap around bundle, 1 x steel strap horizontal around stacking device	

Article No.	Article Name	Article Image
424605	Articulated Corner DGE 150	
amount	6	
load carrier	post pallet RP 120	
packaging method	stacked	
packaging aid	steel strap	
424608	Outside Corner Angle DAW 150	
amount	40	
load carrier	post pallet RP 120	
packaging method	stacked	
packaging aid	steel strap	
425486	Panel D 75 x 35	
amount	24	
load carrier	euro pallet	
packaging method	3 per layer, 8 up	
packaging aid	steel strap	
425494	Panel D 125 x 35	
amount	24	
load carrier	euro pallet	
packaging method	3 per layer, 8 up	
packaging aid	steel strap	
425501	Panel D 250 x 35	
amount	24	
load carrier	bundle	
packaging method	stacked	
packaging aid	steel strap, square timber, dunnage	
425660	Wall Thickness Comp. DWD 150/10	
amount	24	
load carrier	post pallet RP 120	
packaging method	stacked	
packaging aid	steel strap	
425944	Wall Thickness Comp. DWD 150/5	
amount	40	
load carrier	post pallet RP 120	
packaging method	stacked	
packaging aid	steel strap	

Article No.	Article Name	Article Image
426242	Inside Steel Corner DISE 250	
amount	6	
load carrier	post pallet RP 150	
packaging method	stacked	
packaging aid	steel strap	
426274	Inside Steel Corner DISE 75	
amount	18	
load carrier	wire crate k	
packaging method	upright	
packaging aid	steel strap, wooden cover plate	
426280	Inside Steel Corner DISE 125	
amount	6	
load carrier	post pallet RP 120	
packaging method	stacked	
packaging aid	steel strap	
426286	Inside Steel Corner DISE 150	
amount	6	
load carrier	post pallet RP 120	
packaging method	stacked	
packaging aid	steel strap	
426292	DOM. INS.STEEL CORNER DISE 275	
amount	6	
load carrier	post pallet RP 150	
packaging method	3 wide, 2 up	
packaging aid	steel strap	
426298	DOM. INS.STEEL CORNER DISE 300	
amount	6	
load carrier	post pallet RP 150	
packaging method	3 wide, 2 up	
packaging aid	steel strap	
427010	Push-Pull Spread.Domino 15-100	
amount	54	
load carrier	post pallet RP 120	
packaging method	9 wide, 6 up	
packaging aid	steel strap, square timber	

Article No.	Article Name	Article Image
411850	Articulated Corner MXGA 120	
amount	8	
load carrier	post pallet RP 120	
packaging method	2 wide, 4 up	
packaging aid	steel strap, wooden strip between each layer	
411872	Articulated Corner MXGA 270	
amount	8	
load carrier	post pallet RP 150	
packaging method	2 wide, 4 up	
packaging aid	steel strap	
411979	Kicker MXP 118	
amount	40	
load carrier	post pallet RP 120	
packaging method	5 layers, 8 per layer	
packaging aid	steel strap, square timber	
412006	Panel MX 270 x 240	
amount	5	
load carrier	stacking device Maximo	
packaging method	stacked	
packaging aid	steel strap around stacking aid	
412022	Panel MX 270 x 120	
amount	5	
load carrier	stacking device Maximo	
packaging method	stacked	
packaging aid	steel strap around stacking aid	
412045	Panel MX 270 x 90	
amount	5	
load carrier	stacking device Maximo	
packaging method	stacked	
packaging aid	steel strap around stacking aid	
412078	Panel MX 270 x 45	
amount	5	
load carrier	bundle	
packaging method	1 layers, 5 per layer	
packaging aid	steel strap, square timber, dunnage	

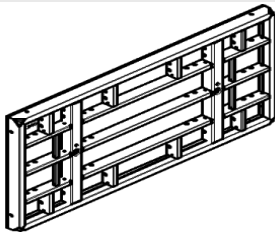
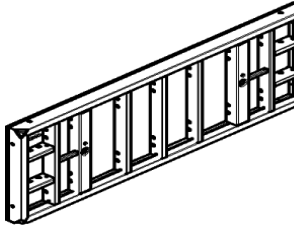
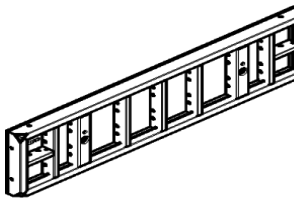
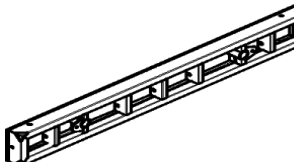
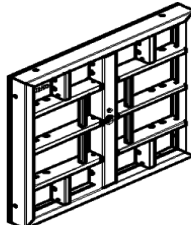
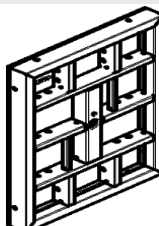

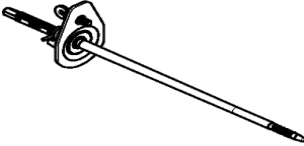
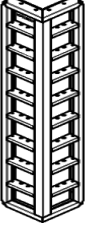
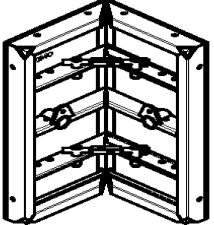
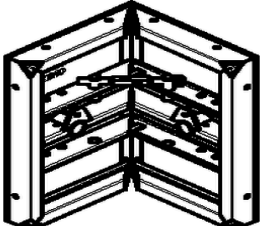
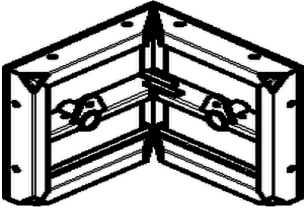
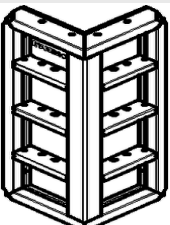
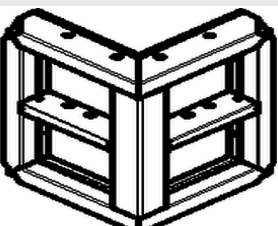

Article No.	Article Name	Article Image
412090	Panel MX 270 x 30	
amount	10	
load carrier	bundle	
packaging method	2 wide, 5 up	
packaging aid	steel strap, square timber, dunnage	
412104	Panel MX 120 x 240	
amount	5	
load carrier	stacking device Maximo	
packaging method	stacked	
packaging aid	steel strap around stacking aid	
412115	Panel MX 90 x 240	
amount	5	
load carrier	stacking device Maximo	
packaging method	stacked	
packaging aid	steel strap around stacking aid	
412126	Panel MX 60 x 240	
amount	5	
load carrier	stacking device Maximo	
packaging method	stacked	
packaging aid	steel strap around stacking aid	
412133	Panel MX 30 x 240	
amount	10	
load carrier	bundle	
packaging method	2 wide, 5 up	
packaging aid	steel strap, square timber, dunnage	
412143	Panel MX 120 x 120	
amount	5	
load carrier	stacking device Maximo	
packaging method	stacked	
packaging aid	steel strap around stacking aid	
412152	Panel MX 120 x 90	
amount	5	
load carrier	stacking device Maximo	
packaging method	stacked	
packaging aid	steel strap around stacking aid	

Article No.	Article Name	Article Image
412200	Panel MX 270 x 60	
amount	5	
load carrier	stacking device Maximo	
packaging method	stacked	
packaging aid	steel strap around stacking aid	
412221	Panel MX 120 x 60	
amount	5	
load carrier	stacking device Maximo	
packaging method	stacked	
packaging aid	steel strap around stacking aid	
412232	Panel MX 120 x 45	
amount	5	
load carrier	euro pallet	
packaging method	1 layers, 5 per layer	
packaging aid	steel strap, square timber	
412239	Panel MX 120 x 30	
amount	20	
load carrier	euro pallet	
packaging method	4 wide, 8 up	
packaging aid	steel strap, dunnage	
412252	Panel MX 90 x 90	
amount	5	
load carrier	stacking device Maximo	
packaging method	stacked	
packaging aid	steel strap around stacking aid	
412259	Panel MX 90 x 60	
amount	5	
load carrier	euro pallet	
packaging method	1 wide, 5 up	
packaging aid	steel strap	
412265	Panel MX 90 x 45	
amount	5	
load carrier	euro pallet	
packaging method	1 wide, 5 up	
packaging aid	steel strap	

Article No.	Article Name	Article Image
412271	Panel MX 90 x 30	
amount	20	
load carrier	euro pallet	
packaging method	4 wide, 8 up	
packaging aid	steel strap	
412280	Panel MX 60 x 60	
amount	10euro pallet	
load carrier	2 layers, 5 per layer	
packaging method	steel strap	
packaging aid		
412286	Panel MX 60 x 45	
amount	14	
load carrier	euro pallet	
packaging method	8 layers, 4 per layer	
packaging aid	steel strap	
412292	Panel MX 60 x 30	
amount	28	
load carrier	euro pallet	
packaging method	6 wide, 8 up	
packaging aid	steel strap	
412386	MX 15 Wingnut	
amount	400	
load carrier	wire crate k	
packaging method	6 layers, 50 per layer	
packaging aid	steel strap, wooden plate between each layer, wooden cover plate	
412387	MX 15 Tie 20 – 30	
amount	100	
load carrier	wire crate k	
packaging method	loose	
packaging aid	steel strap, wooden cover plate, packed in foil	
412419	Inside Corner MXI 270 x 60	
amount	4	
load carrier	bundle	
packaging method	stacked	
packaging aid	steel strap, square timber, dunnage	

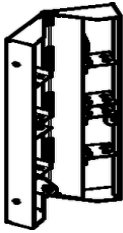
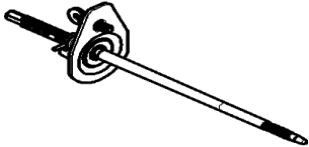
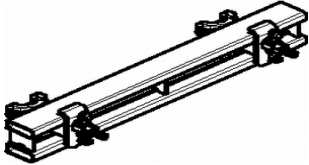
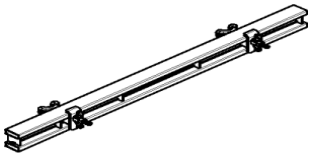
Article No.	Article Name	Article Image
412464	MX 15 Tie 30 – 40	
amount	120	
load carrier	wire crate k	
packaging method	loose	
packaging aid	steel strap, wooden cover plate, packed in foil	
412667	Outside Corner MXA 270 x 35	
amount	4	
load carrier	bundle	
packaging method	stacked	
packaging aid	steel strap, square timber, dunnage	
412689	Inside Corner MXI 120 x 60	
amount	4	
load carrier	euro pallet	
packaging method	stacked	
packaging aid	steel strap	
412715	Inside Corner MXI 90 x 60	
amount	4	
load carrier	euro pallet	
packaging method	stacked	
packaging aid	steel strap	
412726	Inside Corner MXI 60 x 60	
amount	8	
load carrier	euro pallet	
packaging method	stacked	
packaging aid	steel strap	
412761	Outside Corner MXA 120 x 35	
amount	4	
load carrier	euro pallet	
packaging method	stacked	
packaging aid	steel strap	
412778	Outside Corner MXA 60 x 35	
amount	8	
load carrier	euro pallet	
packaging method	stacked	
packaging aid	steel strap	

Article No.	Article Name	Article Image
412806	Outside Corner MXA 270 x 45	
amount	2	
load carrier	bundle	
packaging method	stacked	
packaging aid	steel strap, square timber, dunnage	
412830	Outside Corner MXA 120 x 45	
amount	2	
load carrier	euro pallet	
packaging method	stacked	
packaging aid	steel strap	
412837	Outside Corner MXA 60 x 45	
amount	4	
load carrier	euro pallet	
packaging method	stacked	
packaging aid	steel strap	
412849	Multi Panel MXM 270 x 60	
amount	5	
load carrier	stacking device Maximo	
packaging method	stacked	
packaging aid	steel strap around stacking aid	
412850	Multi Panel MXM 120 x 60	
amount	5	
load carrier	stacking device Maximo	
packaging method	stacked	
packaging aid	steel strap around stacking aid	
412937	Sealing Cone MX 15 – 55	
amount	800	
load carrier	hardware box	
packaging method	16 bags, 50 per bag	
packaging aid	steel strap, wooden cover plate	
413203	Articulated Corner MXGI 270	
amount	4	
load carrier	post pallet RP 150	
packaging method	stacked	
packaging aid	steel strap, wooden strip between each layer	

Article No.	Article Name	Article Image
413246	Articulated Corner MXGI 120	
amount	4	
load carrier	post pallet RP 120	
packaging method	stacked	
packaging aid	steel strap, wooden strip between each layer	
413847	MX 15 Tie 15 – 25	
amount	100	
load carrier	wire crate k	
packaging method	loose	
packaging aid	steel strap, wooden cover plate, packed in foil	
414034	COMPENSATION WALER MAR 85-2	
amount	35	
load carrier	wire crate k	
packaging method	5 wide, 6 up + 5 on the side	
packaging aid	steel strap, wooden cover plate	
414036	Waler MAXIMO MAR 170/2	
amount	20	
load carrier	post pallet RP 120	
packaging method	5 wide, 4 up	
packaging aid	steel strap, dunnage	
414128	Wall Thickness Comp. WDA MX 270 x 10, Alu	
amount	20	
load carrier	post pallet RP 150	
packaging method	5 wide, 4 up	
packaging aid	steel strap, square timber	
414142	Wall Thickness Comp. MX 120 x 10, Alu	
amount	36	
load carrier	wire crate k	
packaging method	6 wide, 6 up	
packaging aid	steel strap, square timber, wooden cover plate	
414165	Wall Thickness Comp. WDA MX 270 x 4	
amount	40	
load carrier	post pallet RP 150	
packaging method	10 wide, 4 up	
packaging aid	steel strap, square timber	

Article No.	Article Name	Article Image
414174	Wall Thickness Comp. WDA MX 270 x 6	
amount	30	
load carrier	post pallet RP 150	
packaging method	5 wide, 6 up	
packaging aid	steel strap, square timber	
414181	Wall Thickness Comp. MX 120 x 6	
amount	54	
load carrier	wire crate k	
packaging method	9 wide, 6 up	
packaging aid	steel strap, square timber, wooden cover plate	
414186	Wall Thickness Comp. WDA MX 270 x 5	
amount	40	
load carrier	post pallet RP 150	
packaging method	10 wide, 4 up	
packaging aid	steel strap, square timber	
414191	Wall Thickness Comp. MX 120 x 5	
amount	60	
load carrier	wire crate k	
packaging method	10 wide, 6 up	
packaging aid	steel strap, square timber, wooden cover plate	
414212	Wall Thickness Comp. MX 120 x 4	
amount	78	
load carrier	wire crate k	
packaging method	6 wide, 13 up	
packaging aid	steel strap, square timber, wooden cover plate	
414248	Panel MX 330 x 120	
amount	5	
load carrier	stacking device Maximo	
packaging method	stacked	
packaging aid	steel strap around stacking aid	
414258	Panel MX 330 x 90	
amount	5	
load carrier	stacking device Maximo	
packaging method	stacked	
packaging aid	steel strap around stacking aid	



Article No.	Article Name	Article Image
414394	Wall Thickness Comp. WDA MX 330 x 10, Alu	
amount	20	
load carrier	post pallet RP 150	
packaging method	5 wide, 4 up	
packaging aid	steel strap, square timber	
414426	Panel MX 330 x 240	
amount	5	
load carrier	stacking device Maximo	
packaging method	stacked	
packaging aid	steel strap around stacking aid	
414445	Panel MX 330 x 60	
amount	5	
load carrier	stacking device Maximo	
packaging method	stacked	
packaging aid	steel strap around stacking aid	
414452	Panel MX 330 x 45	
amount	5	
load carrier	bundle	
packaging method	8 layers, 2 per layer	
packaging aid	steel strap	
414457	Panel MX 330 x 30	
amount	10	
load carrier	bundle	
packaging method	8 layers, 4 per layer	
packaging aid	steel strap, square timber, dunnage	
414464	Multi Panel MXM 330 x 60	
amount	5	
load carrier	stacking device Maximo	
packaging method	stacked	
packaging aid	steel strap around stacking aid	
414470	Inside Corner MXI 330 x 60	
amount	4	
load carrier	bundle	
packaging method	stacked	
packaging aid	steel strap, square timber, dunnage	

Article No.	Article Name	Article Image
414478	Outside Corner MXA 330 x 45	
amount	2	
load carrier	bundle	
packaging method	stacked	
packaging aid	steel strap, square timber, dunnage	
414486	Outside Corner MXA 330 x 35	
amount	4	
load carrier	bundle	
packaging method	stacked	
packaging aid	steel strap, square timber, dunnage	
414569	Front Guardrail MXP 72	
amount	10	
load carrier	post pallet RP 150	
packaging method	stacked	
packaging aid	steel strap	
414583	Articulated Corner MXGI 330	
amount	4	
load carrier	post pallet RP 150	
packaging method	stacked	
packaging aid	steel strap, square timber	
414607	Articulated Corner MXGA 330	
amount	8	
load carrier	post pallet RP 150	
packaging method	2 wide, 4 up	
packaging aid	steel strap	
414797	Magnet Core Spanner MX	
amount	1	
load carrier	loose	
packaging method	loose	
packaging aid		
414826	Wall Thickness Comp. WDA MX 330 x 5	
amount	40	
load carrier	post pallet RP 150	
packaging method	10 wide, 4 up	
packaging aid	steel strap, square timber	

Article No.	Article Name	Article Image
414842	Wall Thickness Comp. WDA MX 330 x 4	
amount	40	
load carrier	post pallet RP 150	
packaging method	10 wide, 4 up	
packaging aid	steel strap, square timber	
414846	Wall Thickness Comp. WDA MX 330 x 6	
amount	30	
load carrier	post pallet RP 150	
packaging method	5 wide, 6 up	
packaging aid	steel strap, square timber	
415058	Stacking Device MAXIMO	
amount	60	
load carrier	wire crate k	
packaging method	stacked	
packaging aid	steel strap, wooden cover plate	
415168	Lifting Hook MAXIMO 1.5 t	
amount	120	
load carrier	wire crate k	
packaging method	stacked	
packaging aid	steel strap, wooden cover plate	
415255	Inside Corner MXI 270 x 50/20	
amount	4	
load carrier	bundle	
packaging method	4 wide, 2 up	
packaging aid	steel strap, stacking device MXI, dunnage	
415299	Inside Corner MXI 120 x 50/20	
amount	4	
load carrier	euro pallet	
packaging method	stacked	
packaging aid	steel strap	
415307	Inside Corner MXI 90 x 50/20	
amount	8	
load carrier	euro pallet	
packaging method	stacked	
packaging aid	steel strap	

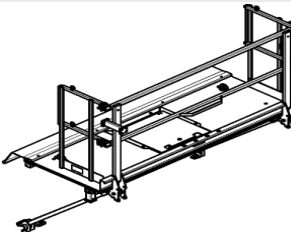
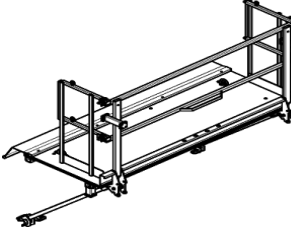
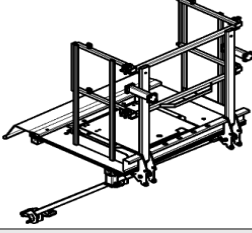
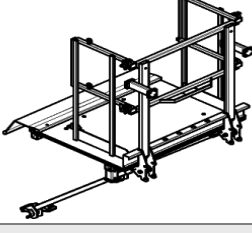
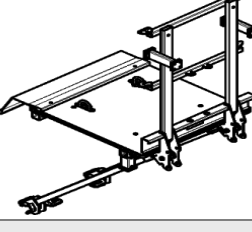
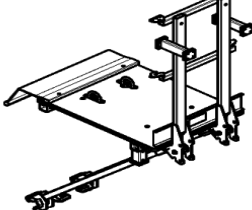
Article No.	Article Name	Article Image
415315	Inside Corner MXI 60 x 50/20	
amount	4	
load carrier	euro pallet	
packaging method	stacked	
packaging aid	steel strap	
415338	Inside Corner MXI 330 x 50/20	
amount	4	
load carrier	bundle	
packaging method	stacked	
packaging aid	steel strap, square timber, dunnage	
415350	Tension and Compression Brace MX 15 – 40	
amount	120	
load carrier	wire crate k	
packaging method	stacked	
packaging aid	steel strap, wooden cover plate	
415430	Ladder Connector MXP	
amount	20	
load carrier	wire crate k	
packaging method	loose	
packaging aid	steel strap, wooden cover plate	
415640	Bulkhead Tie MX DW 20	
amount	100	
load carrier	hardware box	
packaging method	loose	
packaging aid	steel strap, wooden cover plate	
415915	Ladder MXP 270	
amount	22	
load carrier	post pallet RP 150	
packaging method	stacked, upright	
packaging aid	steel strap	
415926	Platform Extension MXP 25	
amount	140	
load carrier	hardware box	
packaging method	5 layers, 28 per layer	
packaging aid	steel strap, wooden cover plate	

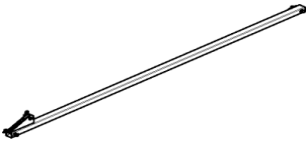
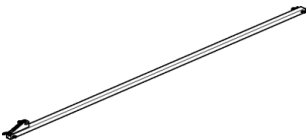
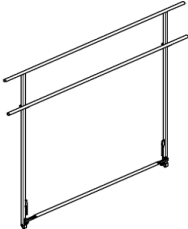
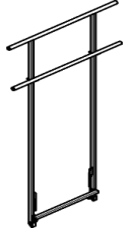
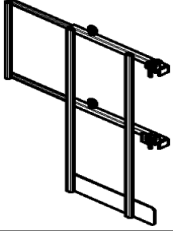
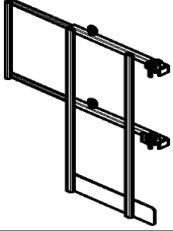
Article No.	Article Name	Article Image
415933	Platform Extension MXP 15	
amount	210	
load carrier	hardware box	
packaging method	5 layers, 42 per layer	
packaging aid	steel strap, wooden cover plate	
415935	Platform MXP 240 x 100 with Hatch	
amount	1	
load carrier	loose	
packaging method	stacked	
packaging aid		
415936	Platform MXP 240 x 100 without Hatch	
amount	1	
load carrier	loose	
packaging method	stacked	
packaging aid		
415937	Platform MXP 120 x 100 with Hatch	
amount	1	
load carrier	loose	
packaging method	stacked	
packaging aid		
415938	Platform MXP 120 x 100 without Hatch	
amount	1	
load carrier	loose	
packaging method	stacked	
packaging aid		
415939	Platform MXP 90 x 100	
amount	1	
load carrier	loose	
packaging method	stacked	
packaging aid		
415940	Platform MXP 72 x 100	
amount	1	
load carrier	loose	
packaging method	stacked	
packaging aid		

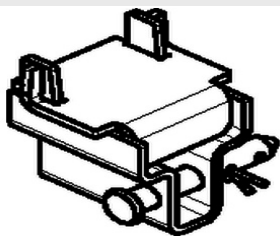
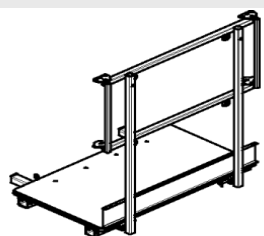
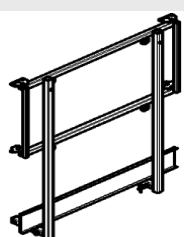
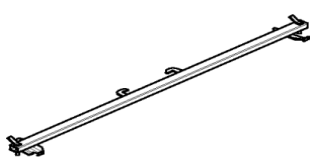
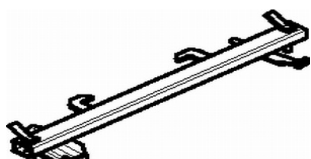
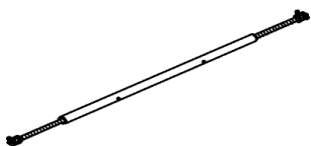
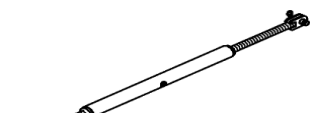

Article No.	Article Name	Article Image
415941	Lattice Strut MXP 270	
amount	48	
load carrier	post pallet RP 150	
packaging method	6 layers, 8 per layer	
packaging aid	steel strap, square timber	
415942	Lattice Strut MXP 330	
amount	48	
load carrier	post pallet RP 150	
packaging method	6 layers, 8 per layer	
packaging aid	steel strap, square timber	
415943	Front Guardrail MXP 240	
amount	20	
load carrier	disposable pallet	
packaging method	stacked	
packaging aid	steel strap	
415944	Front Guardrail MXP 120	
amount	20	
load carrier	bundle	
packaging method	stacked	
packaging aid	steel strap, square timber, dunnage	
415945	End Guardrail MXP left	
amount	20	
load carrier	wire crate k	
packaging method	stacked	
packaging aid	steel strap, wooden cover plate	
415946	End Guardrail MXP right	
amount	20	
load carrier	wire crate k	
packaging method	stacked	
packaging aid	steel strap, wooden cover plate	
415947	Connector for Platform MXP	
amount	30	
load carrier	wire crate k	
packaging method	stacked	
packaging aid	steel strap, wooden cover plate	



Article No.	Article Name	Article Image
415948	Adaptor for Connector Platform MXP	
amount	144	
load carrier	hardware box	
packaging method	2 layers, 72 per layer	
packaging aid	steel strap, wooden cover plate	
415949	End Platform MXP	
amount	10	
load carrier	bundle	
packaging method	stacked	
packaging aid	steel strap, square timber, dunnage	
415950	End Platform Guardrail MXP	
amount	12	
load carrier	post pallet USP 72	
packaging method	stacked	
packaging aid	steel strap	
415951	Bracing MXP 240	
amount	30	
load carrier	post pallet RP 150	
packaging method	6 layers, 5 per layer	
packaging aid	steel strap, square timber	
415952	Bracing MXP 120	
amount	40	
load carrier	wire crate k	
packaging method	8 layers, 5 per layer	
packaging aid	steel strap, wooden cover plate	
415953	Push-Pull Props MXP 270	
amount	45	
load carrier	post pallet RP 150	
packaging method	9 wide, 5 up	
packaging aid	steel strap, square timber	
415954	Push-Pull Props MXP 120	
amount	66	
load carrier	wire crate k	
packaging method	11 wide, 6 up	
packaging aid	steel strap, wooden cover plate	

Article No.	Article Name	Article Image
415955	Erection Device MXP	
amount	12	
load carrier	wire crate k	
packaging method	3 layers, 4 per layer	
packaging aid	steel strap, wooden cover plate	
416346	Ladder Base MXP	
amount	60	
load carrier	hardware box	
packaging method	6 wide, 10 up	
packaging aid	steel strap, wooden cover plate	
416376	Front Guardrail MXP 90	
amount	10	
load carrier	post pallet RP 150	
packaging method	stacked	
packaging aid	steel strap	
416665	Ladder Adaptor MXP 120	
amount	20	
load carrier	wire crate k	
packaging method	10 wide, 2 up	
packaging aid	steel strap, wooden cover plate	
416804	Lattice Strut MXP 240	
amount	48	
load carrier	post pallet RP 150	
packaging method	6 layers, 8 per layer	
packaging aid	steel strap, square timber	
416841	MX 15 Tie Spanner	
amount	1	
load carrier	loose	
packaging method	loose	
packaging aid		
417322	Lifting Gear MX	
amount	1	
load carrier	bag	
packaging method	loose	
packaging aid		

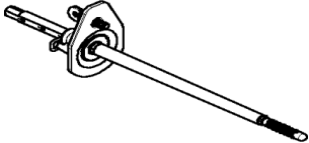
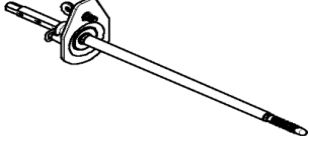
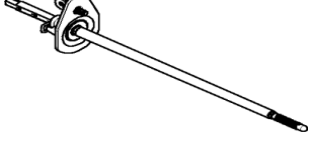
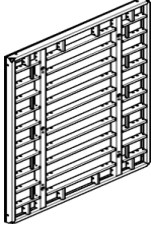
Article No.	Article Name	Article Image
417913	Shaft Corner MXSE 330	
amount	2	
load carrier	bundle	
packaging method	stacked	
packaging aid	steel strap, square timber, dunnage	
417914	Shaft Corner MXSE 270	
amount	2	
load carrier	bundle	
packaging method	stacked	
packaging aid	steel strap, square timber, dunnage	
417915	Shaft Corner MXSE 120	
amount	2	
load carrier	euro pallet	
packaging method	stacked	
packaging aid	steel strap	
418100	Stacking Device MX Flat for Shaft Corner MXSE	
amount	1	
load carrier	loose	
packaging method	loose	
packaging aid		
418103	Stacking Device L MXA	
amount	1	
load carrier	loose	
packaging method	loose	
packaging aid		
418105	Stacking Device R MXA	
amount	1	
load carrier	loose	
packaging method	loose	
packaging aid		
418110	Stacking Device L MXI	
amount	1	
load carrier	loose	
packaging method	loose	
packaging aid		

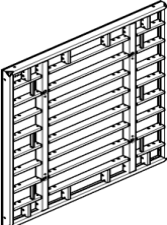
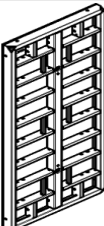
Article No.	Article Name	Article Image
418112	Stacking Device R MXI	
amount	1	
load carrier	loose	
packaging method	loose	
packaging aid		
418450	Load Bearing Capacity Bracing MXP	
amount	60	
load carrier	hardware box	
packaging method	stacked	
packaging aid	steel strap, wooden cover plate	
423604	Sealing MX 18	
amount	10000	
load carrier	hardware box	
packaging method	loose	
packaging aid	steel strap, wooden cover plate	
423842	Tension and Compression Brace MX 15 – 100	
amount	45	
load carrier	post pallet RP 120	
packaging method	stacked	
packaging aid	steel strap	
423900	Wingnut MX 18	
amount	400	
load carrier	wire crate k	
packaging method	5 layers, 50 per layer	
packaging aid	steel strap, wooden cover plate	
423901	Tie MX 18, 15 – 25	
amount	100	
load carrier	wire crate k	
packaging method	loose	
packaging aid	steel strap, wooden cover plate, packed in foil	
423902	Tie MX 18, 20 – 30	
amount	100	
load carrier	wire crate k	
packaging method	loose	
packaging aid	steel strap, wooden cover plate, packed in foil	

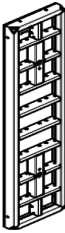
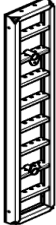
Article No.	Article Name	Article Image
423903	Tie MX 18, 30 – 40	
amount	100	
load carrier	wire crate k	
packaging method	loose	
packaging aid	steel strap, wooden cover plate, packed in foil	
423904	Tie MX 18, 40 – 50	
amount	120	
load carrier	wire crate k	
packaging method	loose	
packaging aid	steel strap, wooden cover plate, packed in foil	
423905	Tie MX 18, 50 – 60	
amount	100	
load carrier	wire crate k	
packaging method	loose	
packaging aid	steel strap, wooden cover plate, packed in foil	
424093	Panel MX 18, 330 x 240	
amount	5	
load carrier	stacking device Maximo	
packaging method	stacked	
packaging aid	steel strap around stacking aid	
424130	Panel MX 18, 330 x 30	
amount	10	
load carrier	bundle	
packaging method	4 wide, 8 up	
packaging aid	steel strap, dunnage	
424132	Panel MX 18, 270 x 240	
amount	5	
load carrier	stacking device Maximo	
packaging method	stacked	
packaging aid	steel strap around stacking aid	
424134	Panel MX 18, 270 x 120	
amount	5	
load carrier	stacking device Maximo	
packaging method	stacked	
packaging aid	steel strap around stacking aid	

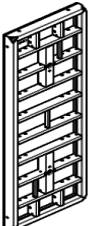
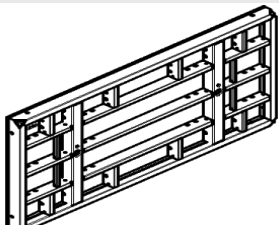
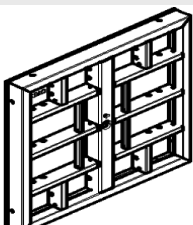
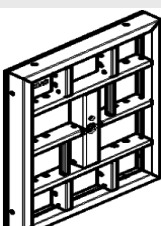
Article No.	Article Name	Article Image
424135	Panel MX 18, 270 x 60	
amount	5	
load carrier	stacking device Maximo	
packaging method	stacked	
packaging aid	steel strap around stacking aid	
424136	Panel MX 18, 270 x 45	
amount	16	
load carrier	bundle	
packaging method	2 wide, 8 up	
packaging aid	steel strap, dunnage	
424137	Panel MX 18, 270 x 30	
amount	32	
load carrier	bundle	
packaging method	4 wide, 8 up	
packaging aid	steel strap, dunnage	
424138	Panel MX 18, 270 x 90	
amount	5	
load carrier	stacking device Maximo	
packaging method	stacked	
packaging aid	steel strap around stacking aid	
424139	Panel MX 18, 120 x 240	
amount	5	
load carrier	stacking device Maximo	
packaging method	stacked	
packaging aid	steel strap around stacking aid	
424142	Panel MX 18, 120 x 120	
amount	5	
load carrier	stacking device Maximo	
packaging method	stacked	
packaging aid	steel strap around stacking aid	
424143	Panel MX 18, 120 x 90	
amount	5	
load carrier	stacking device Maximo	
packaging method	stacked	
packaging aid	steel strap around stacking aid	

Article No.	Article Name	Article Image
424144	Panel MX 18, 120 x 60	
amount	5	
load carrier	stacking device Maximo	
packaging method	stacked	
packaging aid	steel strap around stacking aid	
424146	Panel MX 18, 120 x 30	
amount	32	
load carrier	euro pallet	
packaging method	4 wide, 8 up	
packaging aid	steel strap	
424159	Panel MX 18, 60 x 30	
amount	48	
load carrier	euro pallet	
packaging method	6 wide, 8 up	
packaging aid	steel strap	
424162	Panel MX 18, 30 x 240	
amount	32	
load carrier	bundle	
packaging method	4 wide, 8 up	
packaging aid	steel strap, dunnage	
424188	Multi Panel MXM 18, 270 x 60	
amount	5	
load carrier	stacking device Maximo	
packaging method	stacked	
packaging aid	steel strap around stacking aid	
424189	Multi Panel MXM 18, 120 x 60	
amount	5	
load carrier	stacking device Maximo	
packaging method	stacked	
packaging aid	steel strap around stacking aid	
424941	Waler MAR 85-3	
amount	35	
load carrier	wire crate k	
packaging method	stacked	
packaging aid	steel strap, wooden cover plate	

Article No.	Article Name	Article Image
424942	Waler MAR 170-3	
amount	20	
load carrier	post pallet RP 150	
packaging method	stacked	
packaging aid	steel strap	
425159	Tie Rod Spanner MX18	
amount	1	
load carrier	loose	
packaging method	loose	
packaging aid		
425337	Extraction Tool MX Sealing	
amount	1	
load carrier	loose	
packaging method	loose	
packaging aid		
425693	Scaffold Deck MXK 120	
amount	10	
load carrier	post pallet USP 72	
packaging method	stacked	
packaging aid	steel strap	
426356	Scaffold Bracket MXK	
amount	10	
load carrier	wire crate k	
packaging method	stacked	
packaging aid	steel strap, wooden cover plate	
426357	Stopend Rail MXK	
amount	10	
load carrier	wire crate k	
packaging method	stacked	
packaging aid	steel strap, wooden cover plate	
426360	Guardrail Post MXK	
amount	96	
load carrier	post pallet RP 120	
packaging method	16 wide, 6 up	
packaging aid	steel strap	

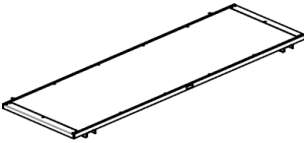
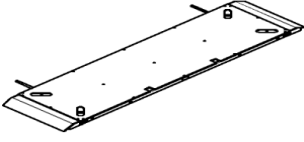
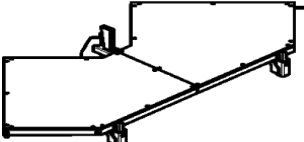
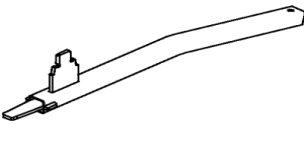
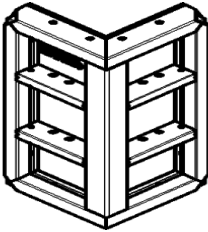
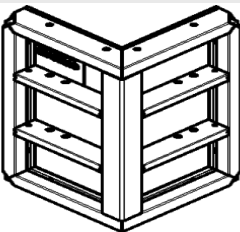
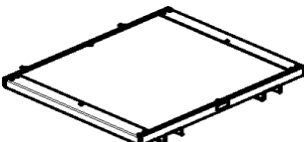
Article No.	Article Name	Article Image
426463	Scaffold Deck MXK 240	
amount	10	
load carrier	post pallet USP 104	
packaging method	stacked	
packaging aid	steel strap	
426541	Compensation Deck MXK	
amount	10	
load carrier	post pallet USP 104	
packaging method	stacked	
packaging aid		
426545	External Corner Deck MXK	
amount	5	
load carrier	post pallet RP 150	
packaging method	stacked	
packaging aid		
426696	Magnet Cone Spanner MX 15 / MX 18	
amount	1	
load carrier	loose	
packaging method	loose	
packaging aid		
426917	Outside Corner MXA 90 x 35	
amount	4	
load carrier	euro pallet	
packaging method	stacked	
packaging aid	steel strap	
426923	Outside Corner MXA 90 x 45	
amount	4	
load carrier	euro pallet	
packaging method	stacked	
packaging aid	steel strap	
426927	Scaffold Deck MXK 90	
amount	10	
load carrier	wire crate k	
packaging method	upright	
packaging aid	steel strap	

Article No.	Article Name	Article Image
427425	Magnet Cone MX 18 – 55	
amount	800	
load carrier	hardware box	
packaging method	16 bags, 50 per bag	
packaging aid	steel strap, wooden cover plate	
427732	Stopend Waler MX 15-40	
amount	40	
load carrier	wire crate k	
packaging method	10 wide, 4 up	
packaging aid	steel strap, wooden cover plate	
428406	Ladder Connector MXK	
amount	45	
load carrier	hardware box	
packaging method	loose	
packaging aid		
428740	Scaffold Deck MXK 240 w. Hatch	
amount	10	
load carrier	post pallet USP 104	
packaging method	stacked	
packaging aid	steel strap	
428829	Inside Corner Post Holder MX	
amount	200	
load carrier	hardware box	
packaging method	loose	
packaging aid		
428941	Lift Lock MXK	
amount	200	
load carrier	hardware box	
packaging method	loose	
packaging aid		

Article No.	Article Name	Article Image
322510	Panel TR 270 x 120	
amount	8	
load carrier	bundle	
packaging method	stacked	
packaging aid	steel strap, square timber, dunnage	
322511	Panel TRIO Structure TS 270 x 120	
amount	8	
load carrier	bundle	
packaging method	stacked	
packaging aid	steel strap, square timber, dunnage	
322514	Panel TR 120 x 240	
amount	8	
load carrier	bundle	
packaging method	stacked	
packaging aid	steel strap, square timber, dunnage	
322520	Panel TR 270 x 90	
amount	8	
load carrier	bundle	
packaging method	stacked	
packaging aid	steel strap, square timber, dunnage	
322521	Panel TRIO Structure TS 270 x 90	
amount	8	
load carrier	bundle	
packaging method	stacked	
packaging aid	steel strap, square timber, dunnage	
322530	Panel TR 270 x 72	
amount	8	
load carrier	bundle	
packaging method	stacked	
packaging aid	steel strap, square timber, dunnage	
322531	Panel TRIO Structure TS 270 x 72	
amount	8	
load carrier	bundle	
packaging method	stacked	
packaging aid	steel strap, square timber, dunnage	





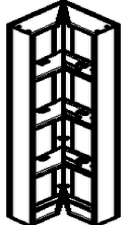
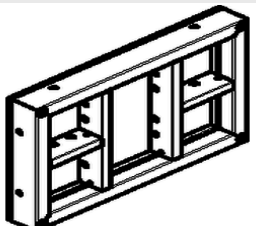
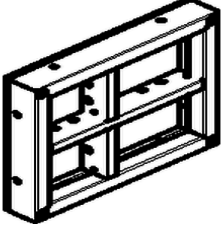
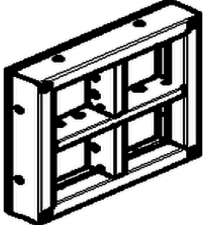
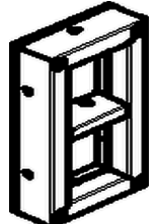

Article No.	Article Name	Article Image
322540	Multi Panel TRM 270 x 72	
amount	8	
load carrier	bundle	
packaging method	stacked	
packaging aid	steel strap, stacking device, dunnage	
322541	Panel TRIO Structure TSM 270 x 72	
amount	8	
load carrier	bundle	
packaging method	stacked	
packaging aid	steel strap, square timber, dunnage	
322550	Panel TR 270 x 60	
amount	8	
load carrier	bundle	
packaging method	stacked	
packaging aid	steel strap, square timber, dunnage	
322551	Panel TRIO Structure TS 270 x 60	
amount	8	
load carrier	bundle	
packaging method	stacked	
packaging aid	steel strap, square timber, dunnage	
322560	Panel TR 270 x 30	
amount	32	
load carrier	bundle	
packaging method	4 wide, 8 up	
packaging aid	steel strap, stacking device	
322561	Panel TRIO Structure TS 270 x 30	
amount	32	
load carrier	bundle	
packaging method	4 wide, 8 up	
packaging aid	steel strap, stacking device, dunnage	
322570	Panel TR 270 x 240	
amount	5	
load carrier	bundle	
packaging method	stacked	
packaging aid	steel strap, stacking device, dunnage	

Article No.	Article Name	Article Image
322571	Panel TRIO Structure TS 270 x 240	
amount	5	
load carrier	bundle	
packaging method	stacked	
packaging aid	steel strap, dunnage	
322580	Inside Corner TE 270-2	
amount	4	
load carrier	bundle	
packaging method	stacked	
packaging aid	steel strap, pallet	
322581	Corner TRIO Structure TSE 270	
amount	4	
load carrier	bundle	
packaging method	stacked	
packaging aid	steel strap, pallet	
322600	Panel TR 120 x 120	
amount	5	
load carrier	bundle	
packaging method	stacked	
packaging aid	steel strap, square timber, dunnage	
322601	Panel TRIO Structure TS 120 x 120	
amount	5	
load carrier	bundle	
packaging method	stacked	
packaging aid	steel strap, square timber, dunnage	
322610	Panel TR 120 x 90	
amount	5	
load carrier	bundle	
packaging method	stacked	
packaging aid	steel strap, square timber, dunnage	
322611	Panel TRIO Structure TS 120 x 90	
amount	5	
load carrier	bundle	
packaging method	stacked	
packaging aid	steel strap, square timber, dunnage	

Article No.	Article Name	Article Image
322620	Panel TR 120 x 72	
amount	5	
load carrier	bundle	
packaging method	stacked	
packaging aid	steel strap, square timber, dunnage	
322621	Panel TRIO Structure TS 120 x 72	
amount	5	
load carrier	bundle	
packaging method	stacked	
packaging aid	steel strap, square timber, dunnage	
322630	Multi Panel TRM 120 x 72	
amount	5	
load carrier	bundle	
packaging method	stacked	
packaging aid	steel strap, square timber, dunnage	
322631	Panel TRIO Structure TSM 120 x 72	
amount	5	
load carrier	bundle	
packaging method	stacked	
packaging aid	steel strap, square timber, dunnage	
322640	Panel TR 120 x 60	
amount	5	
load carrier	bundle	
packaging method	stacked	
packaging aid	steel strap, square timber, dunnage	
322641	Panel TRIO Structure TS 120 x 60	
amount	5	
load carrier	bundle	
packaging method	stacked	
packaging aid	steel strap, square timber, dunnage	
322650	Panel TR 120 x 30	
amount	20	
load carrier	euro pallet	
packaging method	4 wide, 5 up	
packaging aid	steel strap, square timber	

Article No.	Article Name	Article Image
322651	Panel TRIO Structure TS 120 x 30	
amount	20	
load carrier	euro pallet	
packaging method	4 wide, 5 up	
packaging aid	steel strap, square timber	
322660	Inside Corner TE 120-2	
amount	4	
load carrier	euro pallet	
packaging method	2 wide, 2 up	
packaging aid	steel strap, square timber	
322661	Corner TRIO Structure TSE 120	
amount	4	
load carrier	euro pallet	
packaging method	stacked	
packaging aid	steel strap	
322790	Panel TR 60 x 90	
amount	5	
load carrier	euro pallet	
packaging method	2 wide, 2 up	
packaging aid	steel strap	
322800	Panel TR 60 x 72	
amount	10	
load carrier	euro pallet	
packaging method	2 wide, 5 up	
packaging aid	steel strap	
322810	Panel TR 60 x 60	
amount	10	
load carrier	euro pallet	
packaging method	2 wide, 5 up	
packaging aid	steel strap	
322820	Panel TR 60 x 30	
amount	28	
load carrier	euro pallet	
packaging method	5 layers, 2 x 3 per layer	
packaging aid	steel strap	

Article No.	Article Name	Article Image
322840	Inside Corner TE 60-2	
amount	24	
load carrier	euro pallet	
packaging method	2 layers, 2 x 6 per layer	
packaging aid	steel strap	
322950	Concreting Platform TRIO 120 x 270	
amount	1	
load carrier	loose	
packaging method	stacked	
packaging aid	steel strap	
323010	Foundation Tie Clamp TRIO TLS	
amount	300	
load carrier	wire crate k	
packaging method	loose	
packaging aid	steel strap, wooden cover plate	
323030	Stopend Panel TR 120 x 24	
amount	40	
load carrier	euro pallet	
packaging method	5 wide, 8 up	
packaging aid	steel strap	
323040	Stopend Panel TR 270 x 24	
amount	40	
load carrier	bundle	
packaging method	5 wide, 8 up	
packaging aid	steel strap, dunnage	
323050	Stopend Panel TR/4 330 x 24	
amount	40	
load carrier	bundle	
packaging method	5 wide, 8 up	
packaging aid	steel strap, stacking device, dunnage	
323060	Stopend Panel TRIO AT 270 x 3	
amount	20	
load carrier	post pallet RP 150	
packaging method	stacked	
packaging aid	steel strap	

Article No.	Article Name	Article Image
323062	Stopend Panel TRIO MT 270 x 24/25	
amount	16	
load carrier	post pallet RP 150	
packaging method	stacked	
packaging aid	steel strap	
323064	Stopend Panel TRIO MT 270 x 30	
amount	12	
load carrier	post pallet RP 150	
packaging method	stacked	
packaging aid	steel strap	
323065	Stopend Panel TRIO MT 270 x 35/36	
amount	10	
load carrier	post pallet RP 150	
packaging method	stacked	
packaging aid	steel strap	
323067	Stopend Panel TRIO AT 120 x 3	
amount	15	
load carrier	wire crate k	
packaging method	stacked	
packaging aid	steel strap, wooden cover plate	
323069	Stopend Panel TRIO MT 120 x 24/25	
amount	15	
load carrier	wire crate k	
packaging method	stacked	
packaging aid	steel strap, wooden cover plate	
323071	Stopend Panel TRIO MT 120 x 30	
amount	15	
load carrier	wire crate k	
packaging method	stacked	
packaging aid	steel strap, wooden cover plate	
323072	Stopend Panel TRIO MT 120 x 35/36	
amount	12	
load carrier	wire crate k	
packaging method	stacked	
packaging aid	steel strap, wooden cover plate	



Article No.	Article Name	Article Image
323074	Stopend Panel TRIO MTF 270 x 20	
amount	20	
load carrier	post pallet RP 150	
packaging method	stacked	
packaging aid	steel strap	
323075	Stopend Panel TRIO MTF 270 x 24/25	
amount	16	
load carrier	post pallet RP 150	
packaging aid	steel strap	
323076	Stopend Panel TRIO MTF 270 x 35/36	
amount	8	
load carrier	post pallet RP 150	
packaging aid	steel strap	
323077	Stopend Panel TRIO MTF 270 x 30	
amount	12	
load carrier	post pallet RP 150	
packaging aid	steel strap	
323078	Stopend Panel TRIO MTF 120 x 30	
amount	15	
load carrier	wire crate k	
packaging aid	steel strap, wooden cover plate	
323079	Stopend Panel TRIO MTF 120 x 35/36	
amount	12	
load carrier	wire crate k	
packaging aid	steel strap, wooden cover plate	
323080	Stopend Panel TRIO MTF 120 x 24/25	
amount	25	
load carrier	wire crate k	
packaging aid	steel strap, wooden cover plate	

Article No.	Article Name	Article Image
323170	Filler Plate LA 270 x 36	
amount	16	
load carrier	bundle	
packaging method	4 wide, 4 up	
packaging aid	steel strap, square timber, dunnage	
323182	Wall Thickness Comp. WDA-2 270 x 5	
amount	35	
load carrier	post pallet RP 150	
packaging method	5 wide, 7 up	
packaging aid	1. layer bracket downwards, 2.+3. / 4.+5. / 6.+7. layer bracket facing each other	
323192	Wall Thickness Comp. WDA-2 270 x 6	
amount	30	
load carrier	post pallet RP 150	
packaging method	5 wide, 6 up	
packaging aid	1. layer bracket downwards, 2.+3. / 4.+5. layer bracket facing each other, 7. layer bracket upwards	
323200	Articulated Corner TGE 270	
amount	10	
load carrier	bundle	
packaging method	2 wide, 5 up	
packaging aid	steel strap, wooden strip between each layer, dunnage	
323201	Artic. Corner TRIO Structure TSGE 270	
amount	10	
load carrier	bundle	
packaging method	2 wide, 5 up	
packaging aid	steel strap, square timber, dunnage	
323270	Filler Plate LA 120 x 36	
amount	16	
load carrier	bundle	
packaging method	4 wide, 4 up	
packaging aid	steel strap, square timber, dunnage	
323282	Wall Thickness Comp. WDA-2 120 x 5	
amount	60	
load carrier	wire crate k	
packaging method	10 wide, 6 up	
packaging aid	steel strap, square timber, wooden cover plate	

Article No.	Article Name	Article Image
323292	Wall Thickness Comp. WDA-2 120 x 6	
amount	54	
load carrier	wire crate k	
packaging method	9 wide, 6 up	
packaging aid	steel strap, square timber, wooden cover plate	
323300	Articulated Corner TGE 120	
amount	10	
load carrier	bundle	
packaging method	2 wide, 5 up	
packaging aid	steel strap, wooden strip between each layer, dunnage	
323301	Artic. Corner TRIO Structure TSGE 120	
amount	10	
load carrier	bundle	
packaging method	2 wide, 5 up	
packaging aid	steel strap, square timber, dunnage	
323460	Filler Support TPA 270	
amount	78	
load carrier	post pallet RP 150	
packaging method	13 wide, 6 up	
packaging aid	steel strap	
323500	Alignment Coupler BFD, galv.	
amount	150	
load carrier	wire crate k	
packaging method	stacked	
packaging aid	steel strap, wooden cover plate	
323550	Compensation Waler TAR 85	
amount	40	
load carrier	wire crate k	
packaging method	5 wide, 7 up + 5 on the side	
packaging aid	steel strap, wooden cover plate	
323551	Waler 85	
amount	35	
load carrier	wire crate k	
packaging method	5 wide, 6 up + 2	
packaging aid	steel strap, wooden cover plate	

Article No.	Article Name	Article Image
323560	Projection Waler TVR 45/45	
amount	40	
load carrier	wire crate k	
packaging method	stacked	
packaging aid	steel strap, wooden cover plate	
323570	Compensation TRIO TA 250/15	
amount	20	
load carrier	post pallet RP 150	
packaging method	5 wide, 4 up	
packaging aid	steel strap	
323580	Compensation TRIO TA 120/15	
amount	30	
load carrier	post pallet RP 120	
packaging method	5 wide, 6 up	
packaging aid	steel strap, wooden cover plate	
323590	Scaffold Bracket TRG 100/112	
amount	25	
load carrier	post pallet RP 120	
packaging method	stacked	
packaging aid	steel strap	
323630	Top Tie Bracket-2 AH, galv.	
amount	560	
load carrier	wire crate k	
packaging method	7 layers, 80 per layer	
packaging aid	steel strap, wooden plate between each layer, wooden cover plate	
323640	Bulkhead Tie TS, galv.	
amount	400	
load carrier	hardware box	
packaging method	loose	
packaging aid	steel strap, wooden cover plate	
323650	Hook Tie DW 15, l = 400 mm, galv.	
amount	800	
load carrier	wire crate k	
packaging method	loose	
packaging aid	steel strap, wooden cover plate	

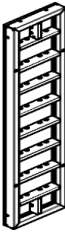
Article No.	Article Name	Article Image
323660	Brace Connector TRIO, galv.	
amount	200	
load carrier	wire crate k	
packaging method	loose	
packaging aid	steel strap, wooden cover plate	
323680	Scaffold Bracket TRG 120	
amount	20	
load carrier	post pallet RP 120	
packaging method	stacked	
packaging aid	steel strap	
323690	Lifting Hook TRIO 1.5 t	
amount	160	
load carrier	wire crate k	
packaging method	stacked	
packaging aid	steel strap, wooden cover plate	
323800	Foundation Strap TRIO	
amount	150	
load carrier	wire crate k	
packaging method	9 rows, 16 per row + 6	
packaging aid	steel strap, wooden cover plate	
323820	Hook Tie Head DW 15, galv.	
amount	500	
load carrier	hardware box	
packaging method	10 bags, 50 per bag	
packaging aid	steel strap, wooden cover plate	
323850	Panel Alu TRA 270 x 90	
amount	5	
load carrier	bundle	
packaging method	stacked	
packaging aid	steel strap, stacking device, dunnage	
323860	Multi Panel Alu TAM 270 x 72	
amount	5	
load carrier	bundle	
packaging method	stacked	
packaging aid	steel strap, stacking device, dunnage	

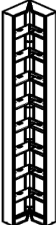
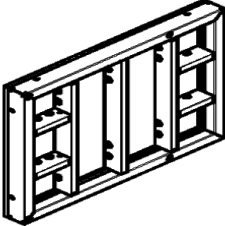
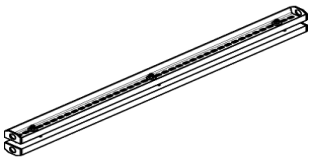
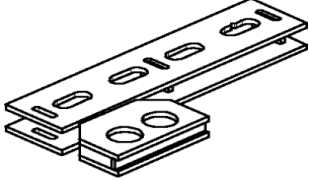
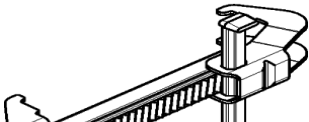
Article No.	Article Name	Article Image
323870	Panel Alu TRA 270 x 60	
amount	5	
load carrier	bundle	
packaging method	stacked	
packaging aid	steel strap, stacking device, dunnage	
323880	Panel Alu TRA 270 x 30	
amount	10	
load carrier	bundle	
packaging method	4 wide, 8 up	
packaging aid	steel strap, stacking device, dunnage	
323891	Corner Alu TAE 270/2	
amount	16	
load carrier	bundle	
packaging method	8 wide, 2 up	
packaging aid	steel strap, square timber, dunnage	
323900	Panel Alu TRA 90 x 120	
amount	5	
load carrier	bundle	
packaging method	stacked	
packaging aid	steel strap, stacking device, dunnage	
323920	Universal Waler 245	
amount	24	
load carrier	bundle	
packaging method	6 wide, 4 up	
packaging aid	steel strap, dunnage	
323930	Waler Stop	
amount	150	
load carrier	hardware box	
packaging method	stacked	
packaging aid	steel strap, wooden cover plate	
323940	Alignment Coupler 38, galv.	
amount	100	
load carrier	wire crate k	
packaging method	stacked	
packaging aid	steel strap, wooden cover plate	

Article No.	Article Name	Article Image
323950	Panel Alu TRA 90 x 60	
amount	16	
load carrier	euro pallet	
packaging method	2 wide, 8 up	
packaging aid	steel strap, stacking device	
323960	Panel Alu TRA 90 x 30	
amount	32	
load carrier	euro pallet	
packaging method	4 wide, 8 up	
packaging aid	steel strap, stacking device	
323971	Corner Alu TAE 90/2	
amount	16	
load carrier	euro pallet	
packaging method	8 wide, 2 up	
packaging aid	steel strap	
323980	Multi Panel Alu TAM 90 x 72	
amount	16	
load carrier	bundle	
packaging method	2 wide, 8 up	
packaging aid	steel strap, stacking device, dunnage	
323990	Wall Thickness Comp. WDA 120 x 10, Alu	
amount	36	
load carrier	wire crate k	
packaging method	6 wide, 6 up	
packaging aid	steel strap, square timber, wooden cover plate	
323995	Wall Thickness Comp. WDA 270 x 10, Alu	
amount	20	
load carrier	post pallet RP 150	
packaging method	5 wide, 4 up	
packaging aid	steel strap, square timber	
344770	Lifting Gear-3 TRIO	
amount	1	
load carrier	loose	
packaging method	in a bag	
packaging aid		

Article No.	Article Name	Article Image
354200	Column Panel TRS 270 x 90	
amount	8	
load carrier	bundle	
packaging method	stacked	
packaging aid	steel strap, stacking device, dunnage	
354210	Column Panel TRS 120 x 90	
amount	8	
load carrier	bundle	
packaging method	stacked	
packaging aid	steel strap, stacking device, dunnage	
354220	Column Panel TRS 60 x 90	
amount	16	
load carrier	euro pallet	
packaging method	2 wide, 8 up	
packaging aid	steel strap, stacking device	
354230	Column Tie Bolt TRIO, galv.	
amount	1000	
load carrier	hardware box	
packaging method	loose	
packaging aid	steel strap, wooden cover plate	
354304	Panel TR/4 330 x 240	
amount	5	
load carrier	bundle	
packaging method	stacked	
packaging aid	steel strap, dunnage	
354305	Panel TRIO Structure TS/4 330 x 240	
amount	5	
load carrier	bundle	
packaging method	stacked	
packaging aid	steel strap, dunnage	
354314	Panel TR/4 330 x 120	
amount	8	
load carrier	bundle	
packaging method	stacked	
packaging aid	steel strap, square timber, dunnage	

Article No.	Article Name	Article Image
354315	Panel TRIO Structure TS/4 330 x 120	
amount	8	
load carrier	bundle	
packaging method	stacked	
packaging aid	steel strap, square timber, dunnage	
354324	Panel TR/4 330 x 90	
amount	8	
load carrier	bundle	
packaging method	stacked	
packaging aid	steel strap, square timber, dunnage	
354325	Panel TRIO Structure TS/4 330 x 90	
amount	8	
load carrier	bundle	
packaging method	stacked	
packaging aid	steel strap, square timber, dunnage	
354334	Panel TR/4 330 x 72	
amount	8	
load carrier	bundle	
packaging method	stacked	
packaging aid	steel strap, square timber, dunnage	
354335	Panel TRIO Structure TS/4 330 x 72	
amount	8	
load carrier	bundle	
packaging method	stacked	
packaging aid	steel strap, square timber, dunnage	
354344	Multi Panel TRM/4 330 x 72	
amount	8	
load carrier	bundle	
packaging method	stacked	
packaging aid	steel strap, square timber, dunnage	
354345	Panel TRIO Structure TSM/4 330 x 72	
amount	8	
load carrier	bundle	
packaging method	stacked	
packaging aid	steel strap, square timber, dunnage	

Article No.	Article Name	Article Image
354354	Panel TR/4 330 x 60	
amount	8	
load carrier	bundle	
packaging method	stacked	
packaging aid	steel strap, square timber, dunnage	
354355	Panel TRIO Structure TS/4 330 x 60	
amount	8	
load carrier	bundle	
packaging method	stacked	
packaging aid	steel strap, square timber, dunnage	
354364	Panel TR/4 330 x 30	
amount	32	
load carrier	bundle	
packaging method	4 wide, 8 up	
packaging aid	steel strap, square timber, dunnage	
354365	Panel TRIO Structure TS/4 330 x 30	
amount	32	
load carrier	bundle	
packaging method	4 wide, 8 up	
packaging aid	steel strap, square timber, dunnage	
354374	Inside Corner TE/4 330	
amount	16	
load carrier	bundle	
packaging method	8 wide, 2 up	
packaging aid	steel strap, stacking device, dunnage	
354375	Corner TRIO Structure TSE/4 330	
amount	16	
load carrier	bundle	
packaging method	8 wide, 2 up	
packaging aid	steel strap, square timber, dunnage	
354384	Filler Plate LA/4 330 x 36	
amount	16	
load carrier	bundle	
packaging method	4 wide, 4 up	
packaging aid	steel strap, wooden strip between each layer, dunnage	

Article No.	Article Name	Article Image
354391	Wall Thickness Comp. WDA/4 330 x 5	
amount	40	
load carrier	post pallet RP 150	
packaging method	10 wide, 4 up	
packaging aid	steel strap, square timber	
354401	Wall Thickness Comp. WDA/4 330 x 6	
amount	30	
load carrier	post pallet RP 150	
packaging method	5 wide, 6 up	
packaging aid	steel strap, square timber	
354414	Articulated Corner TGE/4 330	
amount	10	
load carrier	bundle	
packaging method	2 wide, 5 up	
packaging aid	steel strap, wooden strip between each layer, dunnage	
354430	Filler Support TPA 330	
amount	78	
load carrier	post pallet RP 150	
packaging method	13 wide, 6 up	
packaging aid	steel strap	
354435	Wall Thickness Comp. WDA/4 330 x 10, Alu	
amount	20	
load carrier	post pallet RP 150	
packaging method	5 wide, 4 up	
packaging aid	steel strap, square timber	
354461	Prop with Kicker TRH 116	
amount	25	
load carrier	post pallet RP 120	
packaging method	stacked	
packaging aid	steel strap	
354515	Ladder 240-270	
amount	as required	
load carrier	post pallet RP 150	
packaging method	stacked	
packaging aid	steel strap	





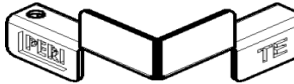
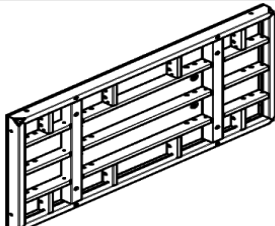

Article No.	Article Name	Article Image
401592	Guardrail Post Holder TRIO	
amount	120	
load carrier	wire crate k	
packaging method	3 layers, 40 per layer	
packaging aid	steel strap, wooden cover plate	
401633	Adjusting Bracket MX	
amount	96	
load carrier	wire crate k	
packaging method	4 rows, 24 per row	
packaging aid	steel strap, wooden cover plate	
403317	Internal Corner TEI 270/135°	
amount	6	
load carrier	post pallet RP 150	
packaging method	stacked	
packaging aid	steel strap, wooden strip between each layer	
403330	Outside Corner TEA 120/135°	
amount	3	
load carrier	post pallet RP 120	
packaging method	stacked	
packaging aid	steel strap, wooden strip between each layer	
403337	Outside Corner TEA 270/135°	
amount	3	
load carrier	post pallet RP 150	
packaging method	stacked	
packaging aid	steel strap, wooden strip between each layer	
403716	TRS Clamp DW 15, galv.	
amount	200	
load carrier	hardware box	
packaging method	loose	
packaging aid	steel strap, wooden cover plate	
403721	TRS Inserting Nut, compl.	
amount	200	
load carrier	hardware box	
packaging method	loose	
packaging aid	steel strap, wooden cover plate	

Article No.	Article Name	Article Image
405523	Shaft Element TSE 270	
amount	6	
load carrier	post pallet RP 150	
packaging method	3 wide, 2 up	
packaging aid	steel strap	
405524	Shaft Element TSE 120	
amount	6	
load carrier	post pallet RP 120	
packaging method	3 wide, 2 up	
packaging aid	steel strap	
405525	Shaft Element TSE 330	
amount	6	
load carrier	post pallet RP 150	
packaging method	3 wide, 2 up	
packaging aid	steel strap	
405953	Stopend Panel TRIO AT 270 x 5	
amount	20	
load carrier	post pallet RP 150	
packaging method	stacked	
packaging aid	steel strap	
405978	Stopend Panel TRIO AT 120 x 5	
amount	15	
load carrier	wire crate k	
packaging method	stacked	
packaging aid	steel strap, wooden cover plate	
408688	Adapter TRIO BPA D=125	
amount	20	
load carrier	wire crate k	
packaging method	stacked	
packaging aid	steel strap, wooden cover plate	
408719	Tie Rod Spanner TRH SW 22	
amount	1	
load carrier	loose	
packaging method	loose	
packaging aid		



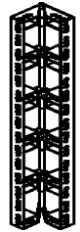

Article No.	Article Name	Article Image
424554	Stacking Device TRIO Corner	
amount	200	
load carrier	wire crate k	
packaging method	loose	
packaging aid	steel strap, wooden cover plate	
426740	Panel TRIO Structure TS 240 x 120	
amount	8	
load carrier	bundle	
packaging method	stacked	
packaging aid	steel strap, square timber, dunnage	



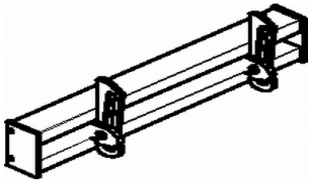
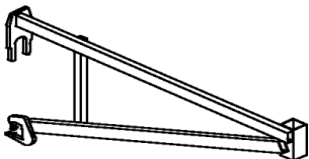
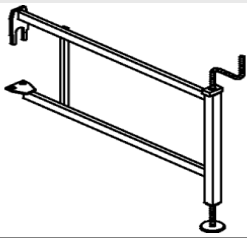

Article No.	Article Name	Article Image
334010	Panel HS 150 x 90	
amount	10	
load carrier	bundle or pallet HS 150	
packaging method	stacked	
packaging aid	steel strap, edge protection, dunnage at bundle	
334020	Panel HS 90 x 120	
amount	10	
load carrier	bundle or pallet HS 120	
packaging method	stacked	
packaging aid	steel strap, edge protection, dunnage at bundle	
334030	Panel HS 90 x 60	
amount	20	
load carrier	bundle or pallet HS 120	
packaging method	2 wide, 10 up	
packaging aid	steel strap, edge protection, dunnage at bundle	
334040	Panel HS 90 x 30	
amount	40	
load carrier	bundle or pallet HS 120	
packaging method	4 wide, 10 up	
packaging aid	steel strap, edge protection, dunnage at bundle	
334050	Panel HS 150 x 60	
amount	13 or 20	
load carrier	bundle or pallet HS 150	
packaging method	10 up + 3 crosswise or 2 wide, 10 up	
packaging aid	steel strap, edge protection, dunnage at bundle	
334060	Panel HS 150 x 30	
amount	30 or 40	
load carrier	bundle or pallet HS 150	
packaging method	3 wide, 10 up or 4 wide, 10 up	
packaging aid	steel strap, edge protection, dunnage at bundle	
334070	Panel HS 120 x 60	
amount	13 or 20	
load carrier	bundle or pallet HS 120	
packaging method	10 up + 3 crosswise or 2 wide, 10 up	
packaging aid	steel strap, edge protection, dunnage at bundle	

Article No.	Article Name	Article Image
334080	Panel HS 120 x 30	
amount	30 or 40	
load carrier	bundle or pallet HS 120	
packaging method	3 wide, 10 up or 4 wide, 10 up	
packaging aid	steel strap, edge protection, dunnage at bundle	
334100	Multi Panel HSM 150 x 45	
amount	20	
load carrier	bundle or pallet HS 150	
packaging method	2 wide, 10 up	
packaging aid	steel strap, edge protection, dunnage at bundle	
334110	Multi Panel HSM 120 x 45	
amount	20	
load carrier	bundle or pallet HS 120	
packaging method	2 wide, 10 up	
packaging aid	steel strap, edge protection, dunnage at bundle	
334120	Multi Panel HSM 90 x 45	
amount	20 or 30	
load carrier	bundle or pallet HS 150	
packaging method	2 wide, 10 up or 3 wide, 10 up	
packaging aid	steel strap, edge protection, dunnage at bundle	
334130	Filler Panel HSAP 150 x 15	
amount	80	
load carrier	euro pallet or pallet HS 150	
packaging method	8 wide, 10 up	
packaging aid	steel strap	
334140	Filler Panel HSAP 90 x 15	
amount	80	
load carrier	euro pallet	
packaging method	8 wide, 10 up	
packaging aid	steel strap	
334150	Inside Corner HSE 150	
amount	12	
load carrier	post pallet RP 150	
packaging method	6 wide, 2 up	
packaging aid	steel strap	

Article No.	Article Name	Article Image
334160	Inside Corner HSE 90	
amount	20	
load carrier	wire crate k or euro pallet	
packaging method	stacked	
packaging aid	steel strap, wooden cover plate	
334170	Filler Plate HSLA 150	
amount	100	
load carrier	post pallet RP 120	
packaging method	stacked	
packaging aid	steel strap, wooden strip between each layer	
334180	Filler Plate HSLA 90	
amount	160	
load carrier	wire crate k	
packaging method	stacked	
packaging aid	steel strap, wooden cover plate	
334200	Articulated Corner HSG 150	
amount	12	
load carrier	post pallet RP 150	
packaging method	stacked	
packaging aid	steel strap	
334210	Articulated Corner HSG 90	
amount	12	
load carrier	post pallet RP 120	
packaging method	stacked	
packaging aid	steel strap	
334220	Inside Corner HSE 120	
amount	12	
load carrier	post pallet RP 120	
packaging method	6 wide, 2 up	
packaging aid	steel strap	
334230	Articulated Corner HSG 120	
amount	12	
load carrier	post pallet RP 120	
packaging method	stacked	
packaging aid	steel strap	

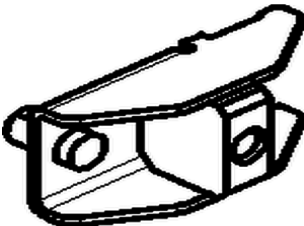
Article No.	Article Name	Article Image
334240	Outside Corner Angle HSW 120	
amount	144	
load carrier	wire crate k	
packaging method	stacked	
packaging aid	steel strap, wooden cover plate	
334250	Outside Corner Angle HSW 150	
amount	100	
load carrier	post pallet RP 120	
packaging method	stacked	
packaging aid	steel strap, wooden strip between each layer	
334260	Outside Corner Angle HSW 90	
amount	160	
load carrier	wire crate k	
packaging method	stacked	
packaging aid	steel strap, wooden cover plate	
334280	Filler Panel HSAP 120 x 15	
amount	80	
load carrier	euro pallet or pallet HS 120	
packaging method	8 wide, 10 up	
packaging aid	steel strap	
334290	Filler Plate HSLA 120	
amount	160	
load carrier	wire crate k	
packaging method	stacked	
packaging aid	steel strap, wooden cover plate	
334320	Filler Bar Steel HSAS 150 x 5	
amount	91	
load carrier	post pallet RP 120	
packaging method	stacked	
packaging aid	steel strap	
334330	Filler Bar Steel HSAS 90 x 5	
amount	150	
load carrier	wire crate k	
packaging method	stacked	
packaging aid	steel strap, wooden cover plate	

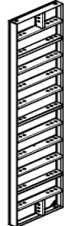
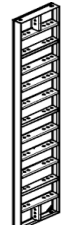
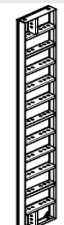
Article No.	Article Name	Article Image
334370	Filler Bar Steel HSAS 120 x 5	
amount	135	
load carrier	wire crate k	
packaging method	stacked	
packaging aid	steel strap, wooden cover plate	
334500	Clip HSC, galv.	
amount	as required	
load carrier	wire crate k	
packaging method	loose	
packaging aid		
334510	Compensation Waler HSR 59	
amount	100	
load carrier	wire crate k	
packaging method	loose	
packaging aid	steel strap, wooden cover plate	
334560	Scaffold Bracket HSK 80	
amount	45	
load carrier	wire crate k	
packaging method	stacked	
packaging aid	steel strap, wooden cover plate	
334570	Bracket HSK 60	
amount	30	
load carrier	post pallet RP 120	
packaging method	2 wide, 15 up	
packaging aid	steel strap	
334580	Handset Handrail Post HSGP	
amount	128	
load carrier	post pallet RP 120	
packaging method	16 wide, 8 up	
packaging aid	steel strap	
334610	Top Tie Bracket HSAH, galv.	
amount	500	
load carrier	wire crate k	
packaging method	loose	
packaging aid	steel strap, wooden cover plate	

Article No.	Article Name	Article Image
412080	CORNER CONNECTOR-2, LIWA	
amount	1000	
load carrier	wire crate k	
packaging method	loose	
packaging aid	steel strap, wooden cover plate	
416292	Guardrail Post HSGP-2	
amount	100	
load carrier	post pallet RP 120	
packaging method	16 wide, 6 up + 4	
packaging aid	steel strap	
416878	PANEL LIWA 300X75	
amount	10	
load carrier	bundle	
packaging method	stacked	
packaging aid	steel strap	
416906	PANEL LIWA 300X60	
amount	20	
load carrier	bundle	
packaging method	stacked	
packaging aid	steel strap	
416916	PANEL LIWA 300X50	
amount	20	
load carrier	bundle	
packaging method	stacked	
packaging aid	steel strap	
416923	PANEL LIWA 300X40	
amount	20	
load carrier	bundle	
packaging method	stacked	
packaging aid	steel strap	
416930	CORNER PANEL LIWA 300X25	
amount	40	
load carrier	bundle	
packaging method	stacked	
packaging aid	steel strap	

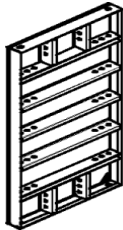
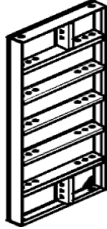
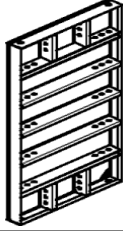
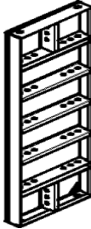
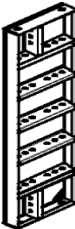
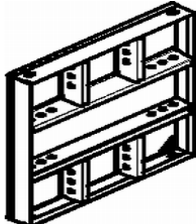
Article No.	Article Name	Article Image
416984	MULTI PANEL LIWA 300X75	
amount	10	
load carrier	bundle	
packaging method	stacked	
packaging aid	steel strap	
417013	PANEL LIWA 150X75	
amount	10	
load carrier	bundle	
packaging method	stacked	
packaging aid	steel strap	
417024	PANEL LIWA 150X60	
amount	20	
load carrier	bundle	
packaging method	stacked	
packaging aid	steel strap	
417029	MULTI PANEL LIWA 150X75	
amount	10	
load carrier	bundle	
packaging method	stacked	
packaging aid	steel strap	
417107	PANEL LIWA 150X50	
amount	20	
load carrier	bundle	
packaging method	stacked	
packaging aid	steel strap	
417111	PANEL LIWA 150X40	
amount	20	
load carrier	bundle	
packaging method	stacked	
packaging aid	steel strap	
417125	PANEL LIWA 75X75	
amount	10	
load carrier	bundle	
packaging method	stacked	
packaging aid	steel strap	

Article No.	Article Name	Article Image
417136	PANEL LIWA 75X60	
amount	20	
load carrier	bundle	
packaging method	stacked	
packaging aid	steel strap	
417140	PANEL LIWA 75X50	
amount	20	
load carrier	bundle	
packaging method	stacked	
packaging aid	steel strap	
417144	PANEL LIWA 75X40	
amount	30	
load carrier	bundle	
packaging method	stacked	
packaging aid	steel strap	
417146	MULTI PANEL LIWA 75X75	
amount	10	
load carrier	bundle	
packaging method	stacked	
packaging aid	steel strap	
417169	BRACE CONNECTOR LIWA	
amount	700	
load carrier	wire crate k	
packaging method	loose	
packaging aid	steel strap, wooden cover plate	
417209	ARTICULATED CORNER LIWA 300	
amount	15	
load carrier	bundle	
packaging method	stacked	
packaging aid	steel strap	
417275	ARTICULATED CORNER LIWA 150	
amount	15	
load carrier	bundle	
packaging method	stacked	
packaging aid	steel strap	

Article No.	Article Name	Article Image
417320	COMPENSATION WALER LWR 60	
amount	100	
load carrier	wire crate k	
packaging method	stacked	
packaging aid	steel strap, wooden cover plate	
417354	SCAFFOLD BRACKET LW 80	
amount	25	
load carrier	wire crate k	
packaging method	stacked	
packaging aid	steel strap, wooden cover plate	
417364	WALL THICKNESS COMP. LIWA 300X5	
amount	48	
load carrier	post pallet RP 150	
packaging method	stacked	
packaging aid	steel strap	
417367	WALL THICKNESS COMP. LIWA 150X5	
amount	48	
load carrier	post pallet RP 120	
packaging method	stacked	
packaging aid	steel strap	
417370	WALL THICKNESS COMP. LIWA 75X5	
amount	100	
load carrier	wire crate k	
packaging method	stacked	
packaging aid	steel strap, wooden cover plate	
417510	CORNER PANEL LIWA 150X25	
amount	40	
load carrier	bundle	
packaging method	stacked	
packaging aid	steel strap	
417541	CORNER PANEL LIWA 75X25	
amount	40	
load carrier	bundle	
packaging method	stacked	
packaging aid	steel strap	

Article No.	Article Name	Article Image
417573	WEDGE CLAMP LIWA	
amount	1000	
load carrier	wire crate k	
packaging method	loose	
packaging aid	steel strap, wooden cover plate	
417677	WEDGE CLAMP COMPENSATION LIWA	
amount	500	
load carrier	wire crate k	
packaging method	loose	
packaging aid	steel strap, wooden cover plate	
417717	PANEL LIWA 250X75	
amount	10	
load carrier	bundle	
packaging method	stacked	
packaging aid	steel strap	
417721	PANEL LIWA 250X60	
amount	20	
load carrier	bundle	
packaging method	stacked	
packaging aid	steel strap	
417725	PANEL LIWA 250X50	
amount	20	
load carrier	bundle	
packaging method	stacked	
packaging aid	steel strap	
417730	PANEL LIWA 250X40	
amount	20	
load carrier	bundle	
packaging method	stacked	
packaging aid	steel strap	
417736	CORNER PANEL LIWA 250X25	
amount	40	
load carrier	bundle	
packaging method	stacked	
packaging aid	steel strap	

Article No.	Article Name	Article Image
417738	MULTI PANEL LIWA 250X75	
amount	10	
load carrier	bundle	
packaging method	stacked	
packaging aid	steel strap	
417746	WALL THICKNESS COMP. LIWA 250X5	
amount	48	
load carrier	post pallet RP 150	
packaging method	stacked	
packaging aid	steel strap	
417747	CRANE HOOK LIWA	
amount	135	
load carrier	wire crate k	
packaging method	loose	
packaging aid	steel strap, wooden cover plate	
417931	LIFTING PIN LIWA	
amount	1000	
load carrier	wire crate k	
packaging method	loose	
packaging aid	steel strap, wooden cover plate	
418380	WALER LWR 80	
amount	100	
load carrier	wire crate k	
packaging method	stacked	
packaging aid	steel strap, wooden cover plate	
418612	CHAMFER STRIP LIWA L = 3,0 M	
amount	300	
load carrier	post pallet RP 150	
packaging method	stacked	
packaging aid	steel strap	
424006	ARTICULATED CORNER LIWA 250	
amount	15	
load carrier	bundle	
packaging method	stacked	
packaging aid	steel strap	

Article No.	Article Name	Article Image
425229	TIMBER HOLDER LIWA	
amount	400	
load carrier	wire crate k	
packaging method	loose	
packaging aid	steel strap, wooden cover plate	
427460	LIWA ALIGNMENT COUPLER LRS	
amount	150	
load carrier	wire crate k	
packaging method	loose	
packaging aid	steel strap, wooden cover plate	
435522	PANEL HSA 150X90	
amount	10	
load carrier	bundle	
packaging method	1 wide,10 up	
packaging aid	steel strap, square timber	
435543	PANEL HSA 120X90	
amount	10	
load carrier	bundle	
packaging method	1 wide,10 up	
packaging aid	steel strap, square timber	
435550	PANEL HSA 300X90	
amount	10	
load carrier	bundle	
packaging method	1 wide,10 up	
packaging aid	steel strap, square timber	
435558	PANEL HSA 150X60	
amount	20	
load carrier	bundle	
packaging method	2 wide,10 up	
packaging aid	steel strap, square timber	
435565	PANEL HSA 150X30	
amount	40	
load carrier	euro pallet	
packaging method	4 wide,10 up	
packaging aid	steel strap	

Article No.	Article Name	Article Image
435569	PANEL HSA 120X60	
amount	20	
load carrier	euro pallet	
packaging method	2 wide, 10 up	
packaging aid	steel strap	
435574	PANEL HSA 300X60	
amount	20	
load carrier	bundle	
packaging method	2 wide, 10 up	
packaging aid	steel strap, square timber	
435578	PANEL HSA 120X30	
amount	40	
load carrier	euro pallet	
packaging method	4 wide, 10 up	
packaging aid	steel strap	
435583	PANEL HSA 300X30	
amount	40	
load carrier	bundle	
packaging method	4 wide, 10 up	
packaging aid	steel strap, square timber	
435631	STOP-END WALER HSA 95	
amount	166	
load carrier	wire crate k	
packaging method	stacked	
packaging aid	steel strap, wooden cover plate	
435635	STOP-END WALER HSA 65	
amount	270	
load carrier	wire crate k	
packaging method	stacked	
packaging aid	steel strap, wooden cover plate	
435745	ALIGNMENT CLAMP HSA	
amount	300	
load carrier	wire crate k	
packaging method	stacked	
packaging aid	steel strap, wooden cover plate	

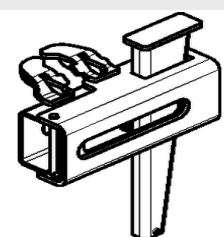





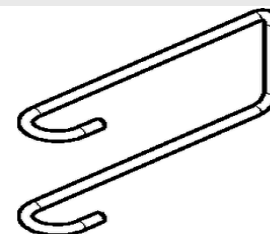

Article No.	Article Name	Article Image
435763	COMPENSATION CLAMP HSA	
amount	336	
load carrier	wire crate k	
packaging method	stacked	
packaging aid	steel strap, wooden cover plate	
435806	FILLER SUPPORT 18 HFS 150	
amount	160	
load carrier	post pallet RP 120	
packaging method	8 wide, 20 up	
packaging aid	steel strap	
435810	FILLER SUPPORT 18 HFS 120	
amount	160	
load carrier	post pallet RP 120	
packaging method	8 wide, 20 up	
packaging aid	steel strap	
435813	FILLER SUPPORT 18 HFS 300	
amount	160	
load carrier	post pallet RP 150	
packaging method	8 wide, 20 up	
packaging aid	steel strap	
435818	WEDGE CLIP HSA	
amount	1500	
load carrier	wire crate k	
packaging method	stacked	
packaging aid	steel strap, wooden cover plate	
435830	INTERNAL CORNER HSA 150	
amount	10	
load carrier	post pallet RP 150	
packaging method	4 wide, 2 up+2	
packaging aid	steel strap	
435835	INTERNAL CORNER HSA 120	
amount	10	
load carrier	post pallet RP 120	
packaging method	4 wide, 2 up+2	
packaging aid	steel strap	



Article No.	Article Name	Article Image
435840	INTERNAL CORNER HSA 300	
amount	10	
load carrier	post pallet RP 150	
packaging method	4 wide, 2 up+2	
packaging aid	steel strap	
435907	SCAFFOLD BRACKET HSA 80	
amount	15	
load carrier	wire crate k	
packaging method	5 wide, 3 up	
packaging aid	steel strap, wooden cover plate	
435911	HOLDER HOOK HSA	
amount	2500	
load carrier	wire crate k	
packaging method	stacked	
packaging aid	steel strap, wooden cover plate	



Article No.	Article Name	Article Image
428245	FILLER SUPPORT 18 DFS 135	
amount	84	
load carrier	post pallet RP 120	
packaging method	14 wide, 6 up	
packaging aid	steel strap, edge protection	
428246	FILLER SUPPORT 15 DFS 135	
amount	84	
load carrier	post pallet RP 120	
packaging method	14 wide, 6 up	
packaging aid	steel strap, edge protection	
428247	COUPLER DUO	
amount	400	
load carrier	hardware box	
packaging method	8 bags, 50 per bag	
packaging aid	steel strap, wooden cover plate	
428254	GRIP DW15 DUO	
amount	800	
load carrier	hardware box	
packaging method	8 bags, 100 per bag	
packaging aid	steel strap, wooden cover plate	
428255	COMPENSATION WALER DUO 62	
amount	160	
load carrier	wire crate k	
packaging method	9 wide, 14 up + 34 standing	
packaging aid	steel strap, wooden cover plate	
428256	COUPLING TIE DUO	
amount	800	
load carrier	hardware box	
packaging method	8 bags, 100 per bag	
packaging aid	steel strap, wooden cover plate	
428257	SCAFFOLD BRACKET DUO 70	
amount	32	
load carrier	wire crate k	
packaging method	2 wide, 11 up standing + 10 on top lying	
packaging aid	steel strap, wooden cover plate	



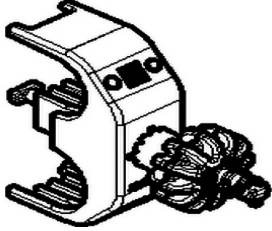
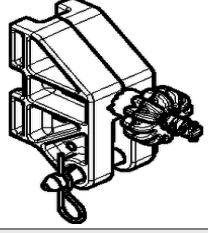
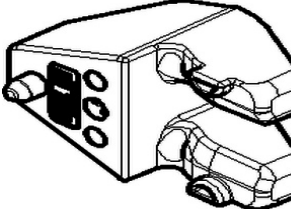
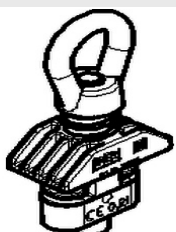
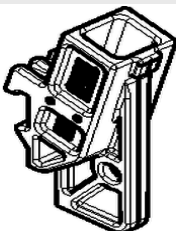

Article No.	Article Name	Article Image
428263	WALL HOLDER DUO 82	
amount	85	
load carrier	wire crate k	
packaging method	5 wide, 17 up	
packaging aid	steel strap, wooden cover plate	
428264	SLAB GUARDRAIL HOLDER DUO	
amount	200	
load carrier	hardware box	
packaging method	2 layers, 100 pcs per layer (10 wide, 10 deep)	
packaging aid	steel strap, wooden cover plate	
428265	CORNER TIE DUO	
amount	1000	
load carrier	wire crate k	
packaging method	loose	
packaging aid	steel strap, wooden cover plate	
428280	PANEL DP 135x90	
amount	10	
load carrier	bundle	
packaging method	stacked	
packaging aid	steel strap, dunnage, edge protection	
428281	MULTI PANEL DMP 135x75	
amount	10	
load carrier	bundle	
packaging method	stacked	
packaging aid	steel strap, dunnage, edge protection	
428282	PANEL DP 135x60	
amount	10	
load carrier	bundle	
packaging method	stacked	
packaging aid	steel strap, dunnage, edge protection	
428283	MULTI PANEL DMP 135x45	
amount	10	
load carrier	bundle	
packaging method	stacked	
packaging aid	steel strap, dunnage, edge protection	

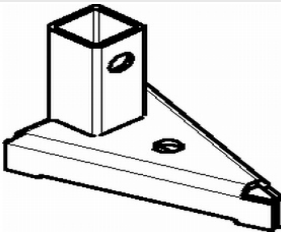
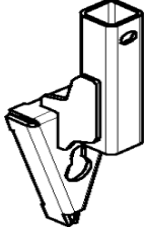
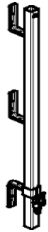
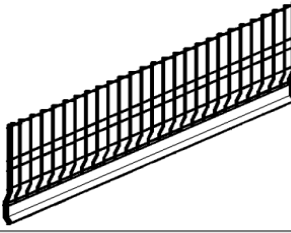
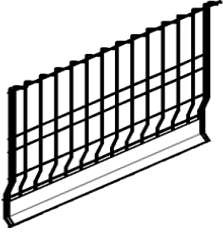
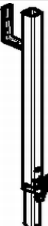

Article No.	Article Name	Article Image
428284	PANEL DP 135x30	
amount	12	
load carrier	post pallet RP 120	
packaging method	2 wide, 6 up	
packaging aid	steel strap, dunnage, edge protection	
428285	PANEL DP 135x15	
amount	24	
load carrier	post pallet RP 120	
packaging method	4 wide, 6 up	
packaging aid	steel strap, dunnage, edge protection	
428286	CORNER DC 135x10	
amount	30	
load carrier	post pallet RP 120	
packaging method	6 wide, 5 up	
packaging aid	steel strap, edge protection	
428287	WALL THICKNESS COMP DWC 135x5	
amount	54	
load carrier	post pallet RP 120	
packaging method	9 wide, 6 up	
packaging aid	steel strap, edge protection	
428288	WALL THICKNESS COMP DWC 135x6	
amount	48	
load carrier	post pallet RP 120	
packaging method	8 wide, 6 up	
packaging aid	steel strap, edge protection	
428289	WALL THICKNESS COMP DWC 135x7	
amount	42	
load carrier	post pallet RP 120	
packaging method	7 wide, 6 up	
packaging aid	steel strap, edge protection	
428290	WALL THICKNESS COMP DWC 135x8	
amount	36	
load carrier	post pallet RP 120	
packaging method	6 wide, 6 up	
packaging aid	steel strap, edge protection	

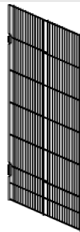

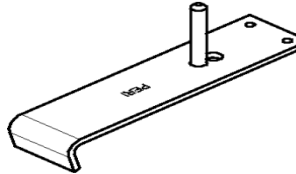
Article No.	Article Name	Article Image
428291	WALL THICKNESS COMP DWC 135X9	
amount	36	
load carrier	post pallet RP 120	
packaging method	6 wide, 6 up	
packaging aid	steel strap, edge protection	
428292	WALL THICKNESS COMP DWC 135x10	
amount	36	
load carrier	post pallet RP 120	
packaging method	6 wide, 6 up	
packaging aid	steel strap, edge protection	
428293	TUBE HOLDER DUO	
amount	160	
load carrier	wire crate k	
packaging method	8 bags, 20 per bag	
packaging aid	steel strap, wooden cover plate	
428294	BRACE CONNECTOR DUO	
amount	140	
load carrier	hardware box	
packaging method	2 layers, 70 pcs per layer (14 wide, 5 deep)	
packaging aid	steel strap, wooden cover plate	
428295	CORNER CONNECTOR DUO	
amount	120	
load carrier	hardware box	
packaging method	3 layers, 40 pcs per layer (10 wide, 4 deep)	
packaging aid	steel strap, wooden cover plate	
428296	CRANE EYE DUO	
amount	160	
load carrier	wire crate k	
packaging method	8 bags, 20 per bag	
packaging aid	steel strap, wooden cover plate	
428297	GUARDRAIL POST HOLDER DUO	
amount	240	
load carrier	wire crate k	
packaging method	12 bags, 20 per bag	
packaging aid	steel strap, wooden cover plate	

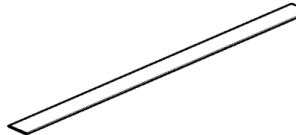
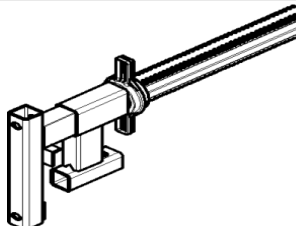
Article No.	Article Name	Article Image
428298	FIX HEAD DFH	
amount	161	
load carrier	wire crate k	
packaging method	3 layers, 46 pcs per layer + 23 on top lying	
packaging aid	steel strap, wooden cover plate	

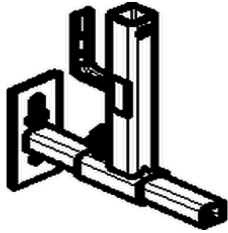
Article No.	Article Name	Article Image
417200	Eyelet-2 PE	
amount	1000	
load carrier	hardware box	
packaging method	loose	
packaging aid	steel strap, wooden cover plate	
417323	Slab Foot PDF	
amount	544	
load carrier	wire crate k	
packaging method	4 rows, 17 per row, 8 up	
packaging aid	steel strap, wooden plate between each layer, wooden cover plate	
417324	Side Foot PSF	
amount	300	
load carrier	wire crate k	
packaging method	loose	
packaging aid	steel strap, wooden cover plate	
417325	Post PP	
amount	150	
load carrier	wire crate k	
packaging method	7 layers, 19 per layer + 17	
packaging aid	steel strap, wooden cover plate, lowest layer with wood	
417326	Side-Mesh-Barrier PMB 260	
amount	25	
load carrier	prokit pallet EP	
packaging method	upright in a row	
packaging aid	lashing strap	
417327	Side-Mesh-Barrier PMB 130	
amount	25	
load carrier	prokit pallet EP	
packaging method	upright in a row	
packaging aid	lashing strap	
418296	Post Increase PPE	
amount	200	
load carrier	wire crate k	
packaging method	stacked	
packaging aid	steel strap, wooden cover plate	

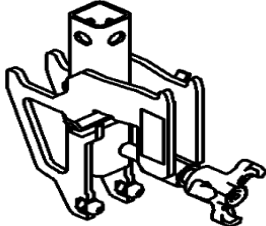
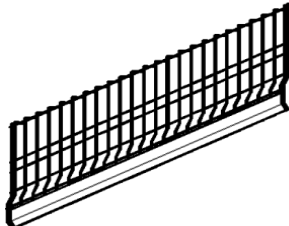
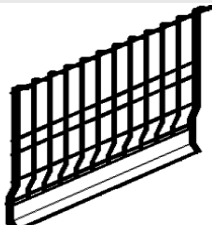
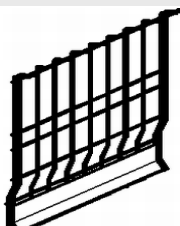
Article No.	Article Name	Article Image
418349	Tension Belt PTB 12	
amount	150	
load carrier	wire crate k	
packaging method	stacked	
packaging aid	steel strap, wooden cover plate	
418350	Fold Mesh Room Height PFR	
amount	45	
load carrier	post pallet RP 120	
packaging method	lying	
packaging aid	steel strap	
418405	Wall Fixing PWF	
amount	300	
load carrier	wire crate k	
packaging method	loose	
packaging aid	steel strap, wooden cover plate	
418406	MP Mounting PMF	
amount	300	
load carrier	wire crate k	
packaging method	loose	
packaging aid	steel strap, wooden cover plate	
418493	Edge Protection Plate PEP	
amount	1000	
load carrier	hardware box	
packaging method	loose	
packaging aid	steel strap, wooden cover plate	
418494	Edge Protector Hose PEH 1 m	
amount	100	
load carrier	wire crate k	
packaging method	stacked	
packaging aid	steel strap, wooden cover plate	
418660	Uni-Clamp PUC	
amount	70	
load carrier	wire crate k	
packaging method	stacked	
packaging aid	steel strap, wooden cover plate	

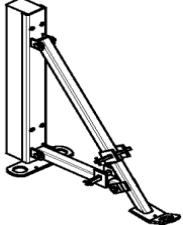
Article No.	Article Name	Article Image
418670	Front Guardrail Holder ADJ PFH	
amount	100	
load carrier	wire crate k	
packaging method	loose	
packaging aid	steel strap, wooden cover plate	
418760	Vertical Coupler PVA	
amount	300	
load carrier	wire crate k	
packaging method	stacked	
packaging aid	steel strap, wooden cover plate	
426330	Sheet Piling Clamp PSC	
amount	100	
load carrier	wire crate k	
packaging method	loose	
packaging aid	steel strap, wooden cover plate	
426371	Side Mesh Barrier PMB 240	
amount	25	
load carrier	pallet EP 110	
packaging method	upright in a row	
packaging aid	tension strap	
426376	Side Mesh Barrier PMB 120	
amount	25	
load carrier	pallet EP 110	
packaging method	upright in a row	
packaging aid	tension strap	
426381	Side Mesh Barrier PMB 90	
amount	25	
load carrier	prokit pallet EP	
packaging method	upright	
packaging aid		

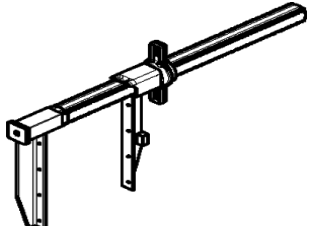
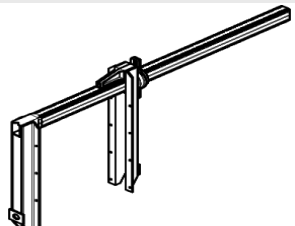
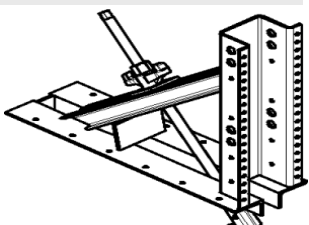
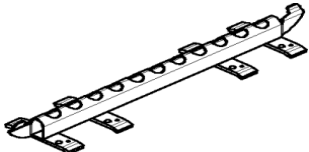
Article No.	Article Name	Article Image
335700	Guardrail Holder-2	
amount	40	
load carrier	wire crate k	
packaging method	stacked	
packaging aid	steel strap, wooden cover plate	
365040	Stopend Trestle	
amount	40	
load carrier	wire crate k	
packaging method	stacked	
packaging aid	steel strap, wooden cover plate	
365042	Peg	
amount	300	
load carrier	hardware box	
packaging method	stacked	
packaging aid	steel strap, wooden cover plate	
365045	Wall Clamp 55	
amount	64	
load carrier	wire crate k	
packaging method	stacked	
packaging aid	steel strap, wooden cover plate	
365046	Wall Clamp 105	
amount	20	
load carrier	wire crate k	
packaging method	stacked	
packaging aid	steel strap, wooden cover plate	
365056	UZ Beam Bracket 40	
amount	30	
load carrier	wire crate k	
packaging method	loose	
packaging aid	steel strap, wooden cover plate	
365057	UZ Beam Width Adjustment Bar 80	
amount	75	
load carrier	wire crate k	
packaging method	loose	
packaging aid	steel strap, wooden cover plate	

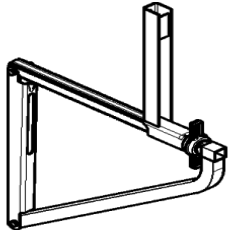
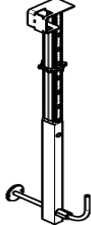
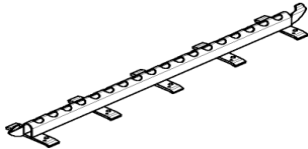
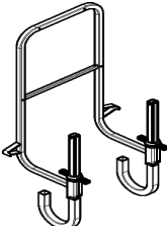
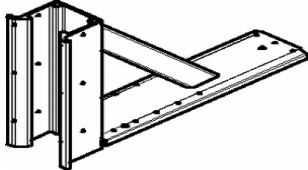
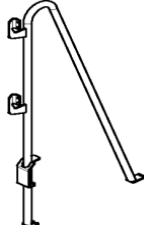
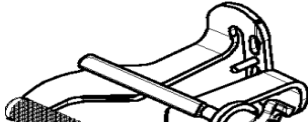
Article No.	Article Name	Article Image
365062	Formwork Bracket-2	
amount	16	
load carrier	wire crate k	
packaging method	loose	
packaging aid	steel strap, wooden cover plate	
365063	Slab Stopend Bar 105	
amount	35	
load carrier	wire crate k	
packaging method	loose	
packaging aid	steel strap, wooden cover plate	
365065	UZ Beam Width Adjustment Bar 129	
amount	50	
load carrier	post pallet RP 120	
packaging method	stacked	
packaging aid	steel strap	
365066	End Guardrail Frame 55	
amount	6	
load carrier	post pallet RP 120	
packaging method	stacked	
packaging aid	steel strap, wooden strip between each layer	
365070	AW Slab Stopend Angle	
amount	144	
load carrier	wire crate k	
packaging method	stacked	
packaging aid	steel strap, wooden cover plate	
365071	AW Handrail Post	
amount	19	
load carrier	post pallet RP 120	
packaging method	stacked	
packaging aid	steel strap	
365072	AW Clamp 8 – 10	
amount	150	
load carrier	wire crate k	
packaging method	loose	
packaging aid	steel strap, wooden cover plate	



Article No.	Article Name	Article Image
365073	Anchor Chain 3.0 kN, l = 2.5 m	
amount	200	
load carrier	hardware box	
packaging method	20 bags, 10 per bag	
packaging aid	steel strap, wooden cover plate	
365074	Turnbuckle 3.0 kN, M12	
amount	600	
load carrier	hardware box	
packaging method	30 bags, 20 per bag	
packaging aid	steel strap, wooden cover plate	
365076	Wall Clamp 75	
amount	50	
load carrier	wire crate k	
packaging method	stacked	
packaging aid	steel strap, wooden cover plate	
408053	Handrail Post RGP 120	
amount	40	
load carrier	wire crate k	
packaging method	loose	
packaging aid	steel strap, wooden cover plate	
411943	Palett Wheel Left	
amount	18	
load carrier	wire crate k	
packaging method	loose	
packaging aid	steel strap, wooden cover plate	
411950	Palett Wheel Right	
amount	18	
load carrier	wire crate k	
packaging method	loose	
packaging aid	steel strap, wooden cover plate	
415151	Guardrail Holder-2	
amount	40	
load carrier	wire crate k	
packaging method	loose	
packaging aid	steel strap, wooden cover plate	

Article No.	Article Name	Article Image
415580	GUARDRAIL HOLDER-2 (US)	
amount	40	
load carrier	wire crate k	
packaging method	3 wide, 13 up + 1 in the middle	
packaging aid	steel strap	

Article No.	Article Name	Article Image
400000	Top Standard UVH 100	
amount	81	
load carrier	wire crate k	
packaging method	stacked	
packaging aid	steel strap, wooden cover plate	
400003	Top Standard UVH 150	
amount	56	
load carrier	post pallet RP 120	
packaging method	8 wide, 7 up	
packaging aid	steel strap	
400005	Top Standard UVH 200	
amount	56	
load carrier	post pallet RP 150	
packaging method	8 wide, 7 up	
packaging aid	steel strap	
400007	Top Standard UVH 250	
amount	56	
load carrier	post pallet RP 150	
packaging method	8 wide, 7 up	
packaging aid	steel strap	
400009	Standard UVR 200	
amount	56	
load carrier	post pallet RP 150	
packaging method	8 wide, 7 up	
packaging aid	steel strap	
400012	Standard UVR 300	
amount	56	
load carrier	post pallet RP 150	
packaging method	8 wide, 7 up	
packaging aid	steel strap	
400013	Standard UVR 400	
amount	56	
load carrier	post pallet RP 150	
packaging method	8 wide, 7 up	
packaging aid	steel strap	

Article No.	Article Name	Article Image
400014	Base Standard UVB 24	
amount	200	
load carrier	wire crate k	
packaging method	3 pcs plugged into each other	
packaging aid	steel strap, wooden cover plate	
400017	Ledger UH 75	
amount	230	
load carrier	wire crate k	
packaging method	32 wide, 7 up + 6	
packaging aid	steel strap, wooden cover plate	
400021	Ledger UH 150	
amount	108	
load carrier	post pallet RP 120	
packaging method	18 wide, 6 up	
packaging aid	steel strap, square timber	
400023	Ledger UH 200	
amount	108	
load carrier	post pallet RP 150	
packaging method	18 wide, 6 up	
packaging aid	steel strap, square timber	
400025	Ledger UH 250	
amount	108	
load carrier	post pallet RP 150	
packaging method	18 wide, 6 up	
packaging aid	steel strap, square timber	
400027	Ledger UH 300	
amount	108	
load carrier	post pallet RP 150	
packaging method	18 wide, 6 up	
packaging aid	steel strap, square timber	
400029	Ledger UH 400	
amount	108	
load carrier	post pallet RP 150	
packaging method	18 wide, 6 up	
packaging aid	steel strap, square timber	

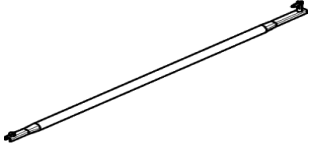
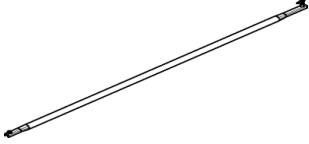
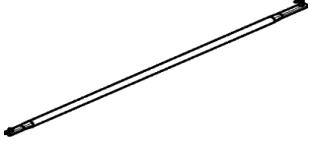
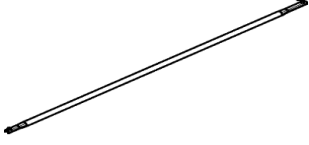
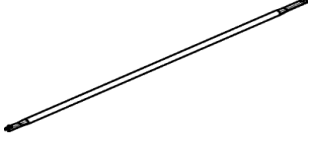
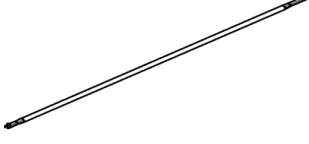
Article No.	Article Name	Article Image
400031	Decking Transom UHD 72	
amount	135	
load carrier	wire crate k	
packaging method	15 wide, 9 up	
packaging aid	steel strap, wooden cover plate	
400039	Decking Transom UHD 104	
amount	90	
load carrier	wire crate k	
packaging method	9 wide, 10 up	
packaging aid	steel strap, wooden cover plate	
400042	Horizontal Brace UBH 150/150	
amount	104	
load carrier	post pallet RP 120	
packaging method	13 wide, 8 up	
packaging aid	steel strap, square timber	
400047	Horizontal Brace UBH 200/200	
amount	104	
load carrier	post pallet RP 150	
packaging method	13 wide, 8 up	
packaging aid	steel strap, square timber	
400049	Horizontal Brace UBH 250/250	
amount	104	
load carrier	post pallet RP 150	
packaging method	13 wide, 8 up	
packaging aid	steel strap, square timber	
400051	Horizontal Brace UBH 300/150	
amount	104	
load carrier	post pallet RP 150	
packaging method	13 wide, 8 up	
packaging aid	steel strap, square timber	
400053	Horizontal Brace UBH 300/300	
amount	95	
load carrier	post pallet RP 150	
packaging method	13 wide, 7 up + 4	
packaging aid	steel strap, square timber	

Article No.	Article Name	Article Image
400055	Ledger Brace UBL 150/100	
amount	225	
load carrier	post pallet RP 120	
packaging method	15 wide, 15 up	
packaging aid	steel strap, square timber	
400057	Ledger Brace UBL 150/200	
amount	225	
load carrier	post pallet RP 150	
packaging method	15 wide, 15 up	
packaging aid	steel strap, square timber	
400059	Ledger Brace UBL 200/100	
amount	225	
load carrier	post pallet RP 150	
packaging method	15 wide, 15 up	
packaging aid	steel strap, square timber	
400061	Ledger Brace UBL 200/200	
amount	195	
load carrier	post pallet RP 150	
packaging method	15 wide, 13 up	
packaging aid	steel strap, square timber	
400063	Ledger Brace UBL 250/100	
amount	225	
load carrier	post pallet RP 150	
packaging method	15 wide, 15 up	
packaging aid	steel strap, square timber	
400065	Ledger Brace UBL 250/200	
amount	180	
load carrier	post pallet RP 150	
packaging method	15 wide, 12 up	
packaging aid	steel strap, square timber	
400067	Ledger Brace UBL 300/100	
amount	180	
load carrier	post pallet RP 150	
packaging method	15 wide, 12 up	
packaging aid	steel strap, square timber	

Article No.	Article Name	Article Image
400069	Ledger Brace UBL 300/200	
amount	165	
load carrier	post pallet RP 150	
packaging method		
packaging aid	steel strap, square timber	
400071	Guardrail Coupler UPR	
amount	300	
load carrier	hardware box	
packaging method	loose	
packaging aid	steel strap, wooden cover plate	
400076	Decking Transom UHD 150	
amount	63	
load carrier	post pallet RP 120	
packaging method	9 wide, 7 up	
packaging aid	steel strap, square timber	
400079	Decking Transom UHD 200	
amount	63	
load carrier	post pallet RP 150	
packaging method	9 wide, 7 up	
packaging aid	steel strap, square timber	
400082	Decking Transom UHD 250	
amount	63	
load carrier	post pallet RP 150	
packaging method	9 wide, 7 up	
packaging aid	steel strap, square timber	
400085	Decking Transom UHD 300	
amount	63	
load carrier	post pallet RP 150	
packaging method	9 wide, 7 up	
packaging aid	steel strap, square timber	
400088	Wall Tie UWT 45	
amount	330	
load carrier	wire crate k	
packaging method	stacked	
packaging aid	steel strap, wooden cover plate	

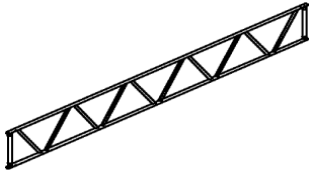
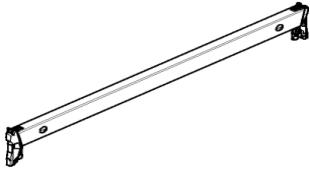
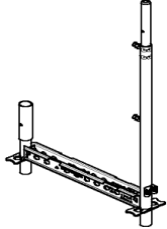
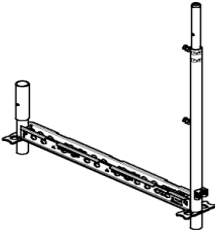
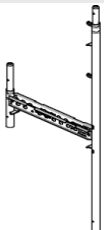
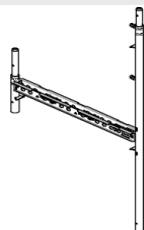
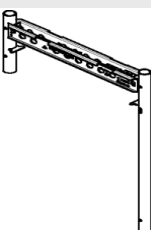

Article No.	Article Name	Article Image
400091	Wall Tie UWT 110	
amount	165	
load carrier	wire crate k	
packaging method	stacked	
packaging aid	steel strap, wooden cover plate	
400093	Wall Tie UWT 140	
amount	104	
load carrier	post pallet RP 120	
packaging method	stacked	
packaging aid	steel strap	
400149	Console Bracket UCB 104	
amount	18	
load carrier	post pallet RP 120	
packaging method	9 lables, 2 against each other stacked	
packaging aid	steel strap	
400159	Adj. Base Plate UJS 38-80/50 Swivel	
amount	140	
load carrier	wire crate k	
packaging method	loose	
packaging aid	steel strap, wooden cover plate	
400170	BASE FRAME UVF 72/174	
amount	36	
load carrier	post pallet USP 72	
packaging method	stacked	
packaging aid	steel strap, tension strap	
400172	Base Frame UVF 104/174	
amount	20	
load carrier	bundle	
packaging method	stacked	
packaging aid	tension strap	
400183	Latt. Girder Steel ULS 70/625	
amount	15	
load carrier	post pallet USP 104	
packaging method	upright	
packaging aid	steel strap	

Article No.	Article Name	Article Image
400185	Latt. Girder Steel ULS 70/525	
amount	15	
load carrier	post pallet USP 104	
packaging method	upright	
packaging aid	steel strap	
400192	Ledger UH 104	
amount	150	
load carrier	wire crate k	
packaging method	21 wide, 7 up + 3	
packaging aid	steel strap, wooden cover plate	
400200	Base Frame UVF 72/124	
amount	30	
load carrier	post pallet USP 72	
packaging method	stacked	
packaging aid	steel strap	
400208	Base Frame UVF 104/124	
amount	28	
load carrier	post pallet USP 104	
packaging method	stacked	
packaging aid	tension strap	
400212	T-Frame UVT 72/200	
amount	36	
load carrier	post pallet USP 72	
packaging method	stacked	
packaging aid	tension strap incl. 36 pcs UV tube 165 (Art.: 400220)	
400216	T-Frame UVT 104/200	
amount	36	
load carrier	post pallet USP 104	
packaging method	stacked	
packaging aid	tension strap incl. 36 pcs UV tube 165 (Art.: 400220)	
400217	L-Frame UVL 72/100	
amount	36	
load carrier	post pallet USP 72	
packaging method	stacked	
packaging aid	tension strap without UV tube	

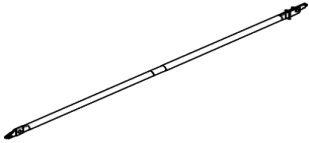
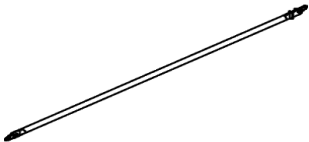
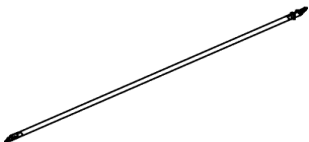
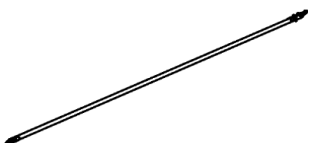
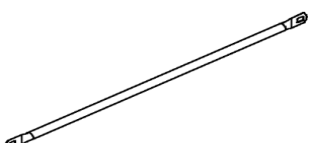
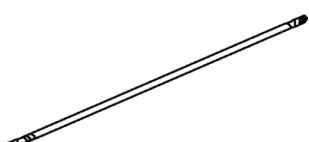
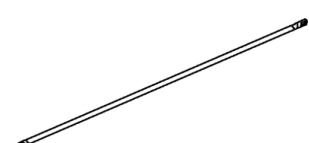
Article No.	Article Name	Article Image
400219	L-Frame UVL 104/100	
amount	36	
load carrier	post pallet USP 104	
packaging method	stacked	
packaging aid	tension strap without UV tube	
400220	Spigot Tube UV 165	
amount	104	
load carrier	post pallet RP 150	
packaging method	13 wide, 8 up	
packaging aid	steel strap, square timber	
400222	Guardrail Post UVP 100	
amount	176	
load carrier	wire crate k	
packaging method	stacked	
packaging aid	steel strap, square timber, wooden cover plate	
400224	Console Bracket UCB 72	
amount	30	
load carrier	wire crate k	
packaging method	loose	
packaging aid	steel strap, wooden cover plate	
400235	Console Bracket UCB 32	
amount	72	
load carrier	wire crate k	
packaging method	loose	
packaging aid	steel strap, wooden cover plate	
400242	Adj. Base Plate UJB 38-80/55	
amount	140	
load carrier	wire crate k	
packaging method	loose	
packaging aid	steel strap, wooden cover plate	
400244	Base Plate UJP	
amount	300	
load carrier	wire crate k	
packaging method	loose	
packaging aid	steel strap, wooden cover plate	

Article No.	Article Name	Article Image
400247	Face Brace UBF 150/200	
amount	135	
load carrier	post pallet RP 150	
packaging method	15 wide, 9 up	
packaging aid	steel strap, square timber	
400253	Face Brace UBF 200/200	
amount	135	
load carrier	post pallet RP 150	
packaging method	15 wide, 9 up	
packaging aid	steel strap, square timber	
400257	Face Brace UBF 250/200	
amount	135	
load carrier	post pallet RP 150	
packaging method	15 wide, 9 up	
packaging aid	steel strap, square timber	
400261	Face Brace UBF 300/200	
amount	135	
load carrier	post pallet RP 150	
packaging method	15 wide, 9 up	
packaging aid	steel strap, square timber	
400265	Guardrail UPG 150	
amount	306	
load carrier	post pallet RP 120	
packaging method	17 wide, 18 up	
packaging aid	steel strap	
400266	Guardrail UPG 200	
amount	306	
load carrier	post pallet RP 150	
packaging method	17 wide, 18 up	
packaging aid	steel strap	
400267	Guardrail UPG 250	
amount	306	
load carrier	post pallet RP 150	
packaging method	17 wide, 18 up	
packaging aid	steel strap	

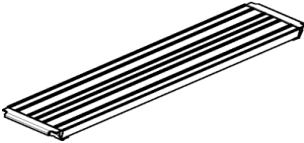
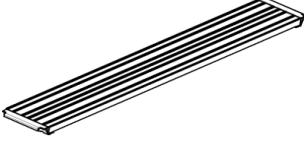
Article No.	Article Name	Article Image
400268	Guardrail UPG 300	
amount	306	
load carrier	post pallet RP 150	
packaging method	17 wide, 18 up	
packaging aid	steel strap	
400301	Spigot ULT 32	
amount	450	
load carrier	hardware box	
packaging method	stacked	
packaging aid	steel strap, wooden cover plate	
400322	Pavement Gantry UVG 176/240	
amount	10	
load carrier	bundle	
packaging method	stacked	
packaging aid	steel strap	
400330	Latt. Girder Steel ULS 50/425	
amount	13	
load carrier	post pallet RP 150	
packaging method	upright	
packaging aid	steel strap	
400336	Latt. Girder Steel ULS 50/525	
amount	13	
load carrier	post pallet RP 150	
packaging method	upright	
packaging aid	steel strap	
400339	Latt. Girder Steel ULS 50/625	
amount	13	
load carrier	post pallet RP 150	
packaging method	upright	
packaging aid	steel strap	
400349	End Guardrail UPX 104	
amount	20	
load carrier	post pallet RP 120	
packaging method	stacked	
packaging aid	steel strap	

Article No.	Article Name	Article Image
400355	Steel Deck UDS 32 x 150	
amount	45	
load carrier	bundle	
packaging method	3 wide, 15 up	
packaging aid	steel strap, square timber, dunnage	
400373	Steel Deck UDS 32 x 200	
amount	45	
load carrier	bundle	
packaging method	3 wide, 15 up	
packaging aid	steel strap, square timber, dunnage	
400375	Steel Deck UDS 32 x 250	
amount	45	
load carrier	bundle	
packaging method	3 wide, 15 up	
packaging aid	steel strap, square timber, dunnage	
400377	Steel Deck UDS 32 x 300	
amount	45	
load carrier	bundle	
packaging method	3 wide, 15 up	
packaging aid	steel strap, square timber, dunnage	
400381	Toe Board Timber UPT 150	
amount	54	
load carrier	post pallet RP 120	
packaging method	18 wide, 3 up	
packaging aid	steel strap, square timber	
400390	Toe Board Timber UPT 200	
amount	54	
load carrier	post pallet RP 150	
packaging method	18 wide, 3 up	
packaging aid	steel strap, square timber	
400393	Toe Board Timber UPT 250	
amount	54	
load carrier	post pallet RP 150	
packaging method	18 wide, 3 up	
packaging aid	steel strap, square timber	

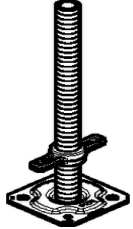
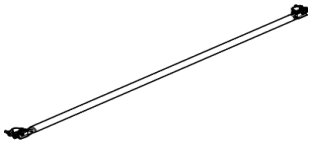
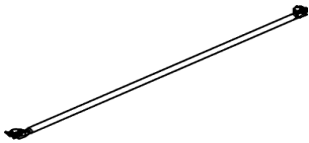
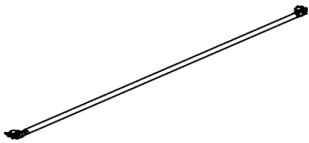
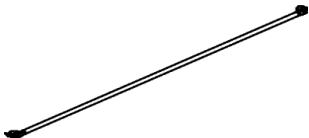
Article No.	Article Name	Article Image
400396	Toe Board Timber UPT 300	
amount	54	
load carrier	post pallet RP 150	
packaging method	18 wide, 3 up	
packaging aid	steel strap, square timber	
400401	Bracket Brace UCP 72/104	
amount	72	
load carrier	post pallet RP 150	
packaging method	12 wide, 6 up	
packaging aid	steel strap, square timber	
400411	Adj. Base Plate UJB 38-50/30	
amount	250	
load carrier	wire crate k	
packaging method	loose	
packaging aid	steel strap, wooden cover plate	
400416	Coupler Brace UBC 150/200	
amount	84	
load carrier	post pallet RP 150	
packaging method	12 wide, 7 up	
packaging aid	steel strap, square timber	
400419	Coupler Brace UBC 200/200	
amount	84	
load carrier	post pallet RP 150	
packaging method	12 wide, 7 up	
packaging aid	steel strap, square timber	
400422	Coupler Brace UBC 250/200	
amount	84	
load carrier	post pallet RP 150	
packaging method	12 wide, 7 up	
packaging aid	steel strap, square timber	
400425	Coupler Brace UBC 300/200	
amount	84	
load carrier	post pallet RP 150	
packaging method	12 wide, 7 up	
packaging aid	steel strap, square timber	

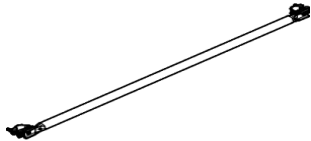
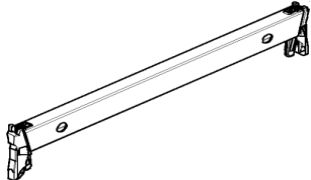
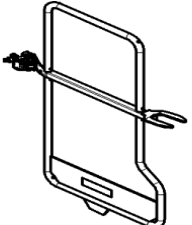
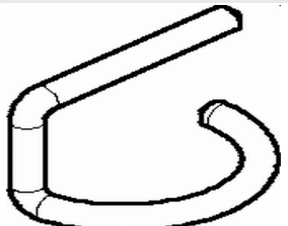
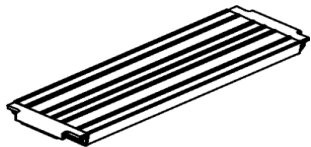
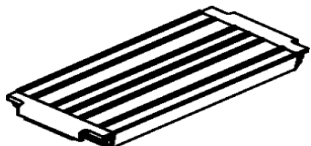
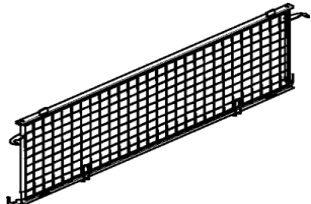
Article No.	Article Name	Article Image
400428	Coupler Brace UBC 72-104/200	
amount	84	
load carrier	post pallet RP 150	
packaging method	12 wide, 7 up	
packaging aid	steel strap, square timber	
400440	Ledger UH 72	
amount	230	
load carrier	wire crate k	
packaging method	32 wide, 7 up + 6	
packaging aid	steel strap, wooden cover plate	
400444	End Guardrail UPX 72	
amount	25	
load carrier	wire crate k	
packaging method	stacked	
packaging aid	steel strap, wooden cover plate	
400478	Locking Pin 48/57	
amount	1000	
load carrier	hardware box	
packaging method	20 bags, 50 per bag	
packaging aid	steel strap, wooden cover plate	
400486	Steel Deck UDS 32 x 104	
amount	26	
load carrier	wire crate k	
packaging method	2 wide, 13 up	
packaging aid	steel strap, wooden cover plate	
400488	Steel Deck UDS 32 x 72	
amount	40	
load carrier	wire crate k	
packaging method	3 wide, 12 up + 4 on the side	
packaging aid	steel strap, wooden cover plate	
400514	Protection Panel UPP 300 x 100	
amount	16 or 20	
load carrier	post pallet RP 120 or USP 72	
packaging method	stacked	
packaging aid	tension strap	

Article No.	Article Name	Article Image
400516	Protection Panel UPP 200 x 100	
amount	16 or 20	
load carrier	post pallet RP 120 or USP 72	
packaging method	stacked	
packaging aid	tension strap	
400523	Access Deck w. Ladder UAL64 x 300/3	
amount	8	
load carrier	post pallet RP 150	
packaging method	stacked	
packaging aid	steel strap	
400524	Access Deck w. Ladder UAL64 x 250/3	
amount	8	
load carrier	post pallet RP 150	
packaging method	stacked	
packaging aid	steel strap	
400529	Starter Tube ULB 50/70	
amount	70	
load carrier	wire crate k	
packaging method	loose	
packaging aid	steel strap, wooden cover plate	
400572	Node Brace UBK 150/200	
amount	105	
load carrier	post pallet RP 150	
packaging method	15 wide, 7 up	
packaging aid	steel strap, square timber	
400573	Node Brace UBK 200/200	
amount	105	
load carrier	post pallet RP 150	
packaging method	15 wide, 7 up	
packaging aid	steel strap, square timber	
400574	Node Brace UBK 250/200	
amount	105	
load carrier	post pallet RP 150	
packaging method	15 wide, 7 up	
packaging aid	steel strap, square timber	

Article No.	Article Name	Article Image
400575	Node Brace UBK 300/200	
amount	105	
load carrier	post pallet RP 150	
packaging method	15 wide, 7 up	
packaging aid	steel strap, square timber	
400579	Decking Gap Filler UD 8/300	
amount	65	
load carrier	wire crate k	
packaging method	stacked	
packaging aid	steel strap, wooden cover plate	
400580	Coupler Transom UHC 72	
amount	100	
load carrier	wire crate k	
packaging method	stacked	
packaging aid	steel strap, wooden cover plate	
400581	Coupler Transom UHC 104	
amount	72	
load carrier	wire crate k	
packaging method	stacked	
packaging aid	steel strap, wooden cover plate	
400583	Connection Protect Panel UPC	
amount	150	
load carrier	wire crate k	
packaging method	stacked	
packaging aid	steel strap, wooden cover plate	
400585	Board Support UHS 150	
amount	65	
load carrier	post pallet RP 150	
packaging method	5 wide, 13 up	
packaging aid	steel strap, square timber on top	
400586	Board Support UHS 200	
amount	65	
load carrier	post pallet RP 150	
packaging method	5 wide, 13 up	
packaging aid	steel strap, square timber on top	

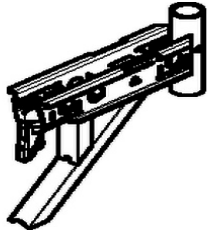
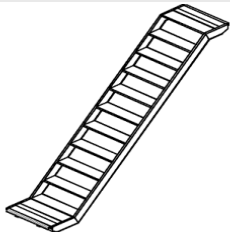
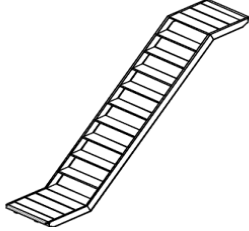
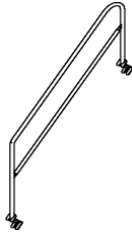
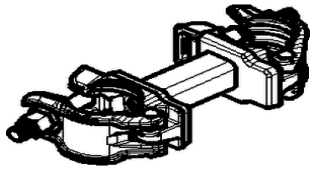
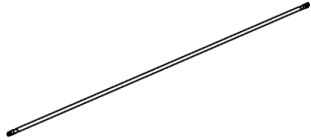
Article No.	Article Name	Article Image
400711	Console Bracket UCB 36	
amount	90	
load carrier	wire crate k	
packaging method	loose	
packaging aid	steel strap, wooden cover plate	
400737	Staircase UAS 64 x 250/200, Alu	
amount	5	
load carrier	post pallet RP 150	
packaging method	upright	
packaging aid	steel strap	
400738	Staircase UAS 64 x 300/200, Alu	
amount	5	
load carrier	post pallet RP 150	
packaging method	upright	
packaging aid	steel strap	
400742	Stair Guardrail UAG	
amount	16	
load carrier	post pallet RP 150	
packaging method	stacked	
packaging aid	steel strap, tension strap	
400750	Spacer UEC 10, galv.	
amount	600	
load carrier	wire crate k	
packaging method	loose	
packaging aid	steel strap, wooden cover plate	
400810	Guardrail UPG 400	
amount	165	
load carrier	post pallet RP 150	
packaging method		
packaging aid	steel strap, square timber on top	
400816	Toe Board Timber UPT 400	
amount	54	
load carrier	post pallet RP 150	
packaging method	18 wide, 3 up	
packaging aid	steel strap, square timber on top	

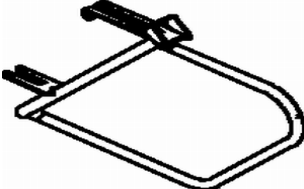
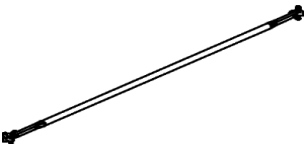
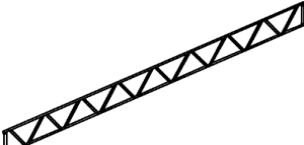
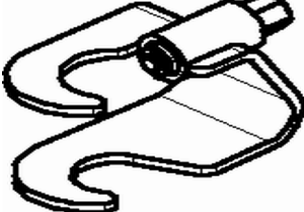
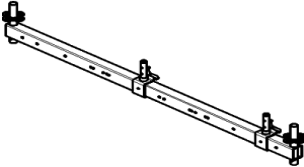
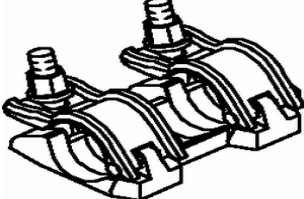

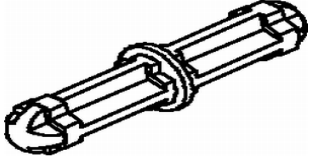
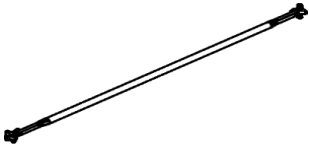
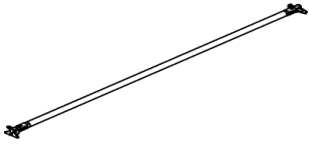
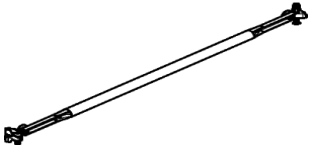
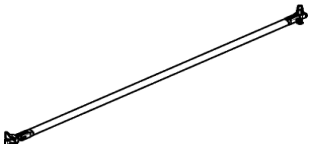
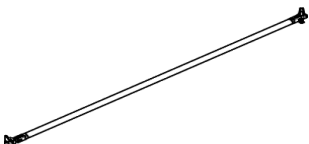
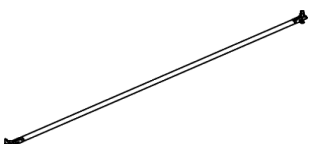
Article No.	Article Name	Article Image
400820	Steel Deck UDS 32 x 400	
amount	45	
load carrier	bundle	
packaging method	3 wide, 15 up	
packaging aid	steel strap, square timber	
400830	Stair Guardrail UAH	
amount	25	
load carrier	wire crate k	
packaging method	stacked	
packaging aid	steel strap, wooden cover plate	
400840	Node Brace UBK 104/200	
amount	105	
load carrier	post pallet RP 150	
packaging method	15 wide, 7 up	
packaging aid	steel strap, square timber	
400852	Latt. Girder Steel ULS 70/825	
amount	15	
load carrier	post pallet USP 104	
packaging method	upright	
packaging aid	steel strap	
400863	Spindle Locking UJS	
amount	900	
load carrier	wire crate k	
packaging method	loose	
packaging aid	steel strap, wooden cover plate	
400870	Base Beam UVA 250	
amount	12	
load carrier	post pallet RP 150	
packaging method	stacked	
packaging aid	steel strap, square timber	
400908	Tension Coupler Ø 48,3 mm, galv.	
amount	200	
load carrier	hardware box	
packaging method	loose	
packaging aid	steel strap, wooden cover plate	

Article No.	Article Name	Article Image
400909	Tube Connector Ø 48,3 mm, galv.	
amount	400	
load carrier	hardware box	
packaging method	loose	
packaging aid	steel strap, wooden cover plate	
400969	Node Brace UBK 72/200	
amount	105	
load carrier	post pallet RP 150	
packaging method	15 wide, 7 up	
packaging aid	steel strap, square timber	
400973	Node Brace UBK 150/150	
amount	105	
load carrier	post pallet RP 150	
packaging method	15 wide, 7 up	
packaging aid	steel strap, square timber	
400977	Node Brace UBK 104/100	
amount	105	
load carrier	post pallet RP 150	
packaging method	15 wide, 7 up	
packaging aid	steel strap, square timber	
400981	Node Brace UBK 150/100	
amount	105	
load carrier	post pallet RP 150	
packaging method	15 wide, 7 up	
packaging aid	steel strap, square timber	
400985	Node Brace UBK 200/100	
amount	105	
load carrier	post pallet RP 150	
packaging method	15 wide, 7 up	
packaging aid	steel strap, square timber	
400989	Node Brace UBK 250/100	
amount	105	
load carrier	post pallet RP 150	
packaging method	15 wide, 7 up	
packaging aid	steel strap, square timber	

Article No.	Article Name	Article Image
400993	Node Brace UBK 300/100	
amount	105	
load carrier	post pallet RP 150	
packaging method	15 wide, 7 up	
packaging aid	steel strap, square timber	
401159	Ledger UH 100	
amount	150	
load carrier	wire crate k	
packaging method	21 wide, 7 up + 3	
packaging aid	steel strap, wooden cover plate	
401306	Standard UVR 100	
amount	81	
load carrier	wire crate k	
packaging method	9 wide, 9 up	
packaging aid	steel strap, wooden cover plate	
401309	Top Standard UVH 50	
amount	200	
load carrier	wire crate k	
packaging method	stacked	
packaging aid	steel strap, wooden cover plate	
401356	Scaffold Plate UEP	
amount	200	
load carrier	wire crate k	
packaging method	stacked	
packaging aid	steel strap, wooden cover plate	
401360	Decking Gap Filler UD 7/150	
amount	121	
load carrier	post pallet RP 120	
packaging method	11 wide, 11 up	
packaging aid	steel strap, square timber	
401372	Decking Gap Filler UD 7/200	
amount	121	
load carrier	post pallet RP 150	
packaging method	11 wide, 11 up	
packaging aid	steel strap, square timber	

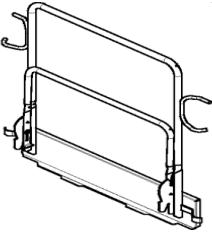
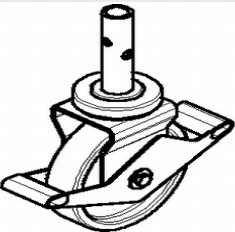
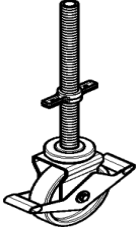
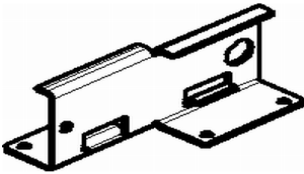
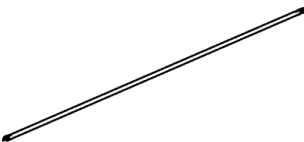

Article No.	Article Name	Article Image
401373	Decking Gap Filler UD 7/250	
amount	121	
load carrier	post pallet RP 150	
packaging method	11 wide, 11 up	
packaging aid	steel strap, square timber	
401375	Decking Gap Filler UD 7/300	
amount	121	
load carrier	post pallet RP 150	
packaging method	11 wide, 11 up	
packaging aid	steel strap, square timber	
401379	Decking Gap Filler UD 11/250	
amount	78	
load carrier	post pallet RP 150	
packaging method	13 wide, 6 up	
packaging aid	steel strap, square timber	
401381	Decking Gap Filler UD 11/300	
amount	78	
load carrier	post pallet RP 150	
packaging method	13 wide, 6 up	
packaging aid	steel strap, square timber	
401394	Decking Gap Filler UD 11/150	
amount	78	
load carrier	post pallet RP 120	
packaging method	13 wide, 6 up	
packaging aid	steel strap, square timber	
401576	Decking Transom Spigot UES	
amount	250	
load carrier	wire crate k	
packaging method	loose	
packaging aid	steel strap, wooden cover plate	
401579	End Guardrail UPX 32	
amount	65	
load carrier	wire crate k	
packaging method	loose	
packaging aid	steel strap, wooden cover plate	

Article No.	Article Name	Article Image
401596	Board Protection UPD 60	
amount	400	
load carrier	wire crate k	
packaging method	stacked	
packaging aid	steel strap, wooden cover plate	
401656	Latt. Girder Alu ULA 50/425 HD	
amount	13	
load carrier	post pallet RP 150	
packaging method	upright	
packaging aid	steel strap	
401657	Latt. Girder Alu ULA 50/525 HD	
amount	13	
load carrier	post pallet RP 150	
packaging method	upright	
packaging aid	steel strap	
401658	Latt. Girder Alu ULA 50/625 HD	
amount	13	
load carrier	post pallet RP 150	
packaging method	upright	
packaging aid	steel strap	
401659	Latt. Girder Alu ULA 70/825 HD	
amount	15	
load carrier	post pallet USP 104	
packaging method	upright	
packaging aid	steel strap	
401671	Landing Link Panel UAB 30	
amount	200	
load carrier	wire crate k	
packaging method	stacked	
packaging aid	steel strap, wooden cover plate	
401731	Ledger to Ledger Coupler UHA	
amount	1000	
load carrier	wire crate k	
packaging method	loose	
packaging aid	steel strap, wooden cover plate	

Article No.	Article Name	Article Image
401799	End Guardrail in Advance UPA 104	
amount	12	
load carrier	post pallet USP 72	
packaging method	stacked	
packaging aid	steel strap or tension strap	
401858	Castor UEW 12 with Spigot	
amount	100	
load carrier	wire crate k	
packaging method	loose	
packaging aid	steel strap, wooden cover plate	
401860	Castor UEW 12 with Spindle	
amount	60	
load carrier	wire crate k	
packaging method	loose	
packaging aid	steel strap, wooden cover plate	
402605	Deck Link Plate UED	
amount	300	
load carrier	hardware box	
packaging method	loose	
packaging aid	steel strap, wooden cover plate	
402617	Horizontal Brace UBH 300/250	
amount	104	
load carrier	post pallet RP 150	
packaging method	13 wide, 8 up	
packaging aid	steel strap	
402846	Ledger Brace UBL 150/150	
amount	180	
load carrier	post pallet RP 150	
packaging method	15 wide, 12 up	
packaging aid	steel strap, square timber	
402859	Standard UVR 50	
amount	162	
load carrier	wire crate k	
packaging method	18 wide, 9 up	
packaging aid	steel strap	

Article No.	Article Name	Article Image
402860	Standard UVR 150	
amount	56	
load carrier	post pallet RP 120	
packaging method	stacked	
packaging aid	steel strap	
402861	Ledger Brace UBL 250/150	
amount	180	
load carrier	post pallet RP 150	
packaging method	15 wide, 12 up	
packaging aid	steel strap, square timber	
402862	Ledger Brace UBL 200/150	
amount	180	
load carrier	post pallet RP 150	
packaging method	15 wide, 12 up	
packaging aid	steel strap, square timber	
402951	Wall Tie UWT 170	
amount	104	
load carrier	post pallet RP 120	
packaging method	stacked	
packaging aid	steel strap, square timber	
402954	Wall Tie UWT 220	
amount	104	
load carrier	post pallet RP 150	
packaging method	13 wide, 8 up	
packaging aid	steel strap, square timber	
402957	Wall Tie UWT 270	
amount	104	
load carrier	post pallet RP 150	
packaging method	13 wide, 8 up	
packaging aid	steel strap, square timber	
403607	Ladder UEL with Hook, Alu	
amount	20	
load carrier	post pallet RP 150	
packaging method	stacked	
packaging aid	steel strap	

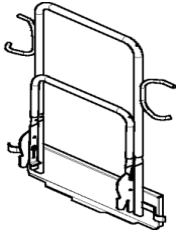
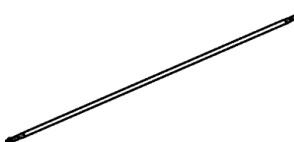
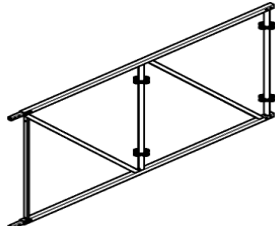
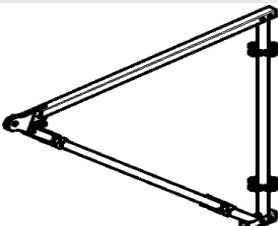
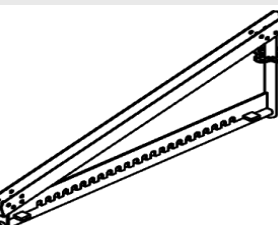
Article No.	Article Name	Article Image
404029	Industrial Deck UDI 25 x 50	
amount	84	
load carrier	wire crate k	
packaging method	stacked	
packaging aid	steel strap	
404077	Keder Connector URA-2	
amount	350	
load carrier	wire crate k	
packaging method	loose	
packaging aid	steel strap, wooden cover plate	
404305	Adjustment Base Plate UJB 38-27/17	
amount	200	
load carrier	wire crate k	
packaging method	stacked	
packaging aid	steel strap, wooden cover plate	
404332	Base D-Frame UVX 250/100	
amount	16	
load carrier	post pallet USP 72	
packaging method	stacked	
packaging aid	steel strap or tension strap	
404356	Horizontal Brace UBH 250/200	
amount	104	
load carrier	post pallet RP 150	
packaging method	13 wide, 8 up	
packaging aid	steel strap, square timber	
404391	Ledger Brace UBL 200/50	
amount	180	
load carrier	post pallet RP 150	
packaging method	15 wide, 12 up	
packaging aid	steel strap, square timber	
404412	Guardrail Coupler UPW	
amount	600	
load carrier	hardware box	
packaging method	loose	
packaging aid	steel strap, wooden cover plate	

Article No.	Article Name	Article Image
404618	End Guardrail in Advance UPA 72	
amount	10	
load carrier	wire crate k	
packaging method	stacked	
packaging aid	steel strap, wooden cover plate	
404762	Ledger Brace UBL 300/ 50	
amount	180	
load carrier	post pallet RP 150	
packaging method	15 wide, 12 up	
packaging aid	steel strap, square timber	
404766	Ledger Brace UBL 300/150	
amount	165	
load carrier	post pallet RP 150	
packaging method		
packaging aid	steel strap, square timber	
404768	LGS Basic Element URB 150/300	
amount	20	
load carrier	bundle	
packaging method	stacked	
packaging aid	steel strap, square timber	
404769	LGS Ridge Element URR 150	
amount	10	
load carrier	post pallet RP 150	
packaging method	stacked	
packaging aid	steel strap	
404771	LGS Support URS 15°	
amount	10	
load carrier	post pallet RP 120	
packaging method	stacked	
packaging aid	steel strap	
404777	Wheel URW	
amount	8	
load carrier	wire crate k	
packaging method	4 wide, 2 up	
packaging aid	steel strap, wooden cover plate	

Article No.	Article Name	Article Image
404779	Ledger UH 50	
amount	300	
load carrier	wire crate k	
packaging method	21 wide, 7 up + 3, x2	
packaging aid	steel strap, wooden cover plate	
404780	Ledger UH 25	
amount	600	
load carrier	wire crate k	
packaging method	loose	
packaging aid	steel strap, wooden cover plate	
404790	Alu Rail URT 150	
amount	8	
load carrier	post pallet RP 120	
packaging method	stacked	
packaging aid	steel strap	
404791	Alu Rail URT 200	
amount	8	
load carrier	post pallet RP 150	
packaging method	stacked	
packaging aid	steel strap	
404792	LGS Additional Element URB 150/150	
amount	40	
load carrier	bundle	
packaging method	stacked	
packaging aid	steel strap, square timber	
404796	Alu Rail URT 250	
amount	8	
load carrier	post pallet RP 150	
packaging method	stacked	
packaging aid	steel strap	
404797	Alu Rail URT 300	
amount	8	
load carrier	post pallet RP 150	
packaging method	stacked	
packaging aid	steel strap	



Article No.	Article Name	Article Image
404852	Rail End Element URD	
amount	250	
load carrier	hardware box	
packaging method	loose	
packaging aid	steel strap, wooden cover plate	
404853	Rail Support URF	
amount	70	
load carrier	wire crate k	
packaging method	loose	
packaging aid	steel strap, wooden cover plate	
404854	Support Roller UEW unstopped	
amount	100	
load carrier	wire crate k	
packaging method	loose	
packaging aid	steel strap, wooden cover plate	
404891	LGS Ridge Bar UR 150°	
amount	64	
load carrier	post pallet RP 150	
packaging method	8 wide, 8 up	
packaging aid	steel strap	
405334	LGS End Element URB 150	
amount	56	
load carrier	post pallet RP 120	
packaging method	8 wide, 7 up	
packaging aid	steel strap	
405366	LGS Collar URP	
amount	100	
load carrier	wire crate k	
packaging method	loose	
packaging aid	steel strap, wooden cover plate	
405372	Spigot w. Spacer URE 4/42	
amount	200	
load carrier	hardware box	
packaging method	loose	
packaging aid	steel strap, wooden cover plate	

Article No.	Article Name	Article Image
405386	LGS Ledger URL 150/14	
amount	32	
load carrier	post pallet RP 120	
packaging method	8 wide, 4 up	
packaging aid	steel strap	
405390	LGS Ledger URL 104/14	
amount	45	
load carrier	wire crate k	
packaging method	9 wide, 5 up	
packaging aid	steel strap, wooden cover plate	
405394	LGS Ledger URL 72/14	
amount	52	
load carrier	post pallet RP 120	
packaging method	stacked	
packaging aid	steel strap	
405398	LGS Bearer URS	
amount	10	
load carrier	wire crate k	
packaging method	loose	
packaging aid	steel strap, wooden cover plate	
405399	LGS Support URS 0°	
amount	18	
load carrier	post pallet RP 120	
packaging method	stacked	
packaging aid	steel strap, square timber	
405824	Coupling for UH	
amount	700	
load carrier	wire crate k	
packaging method	loose	
packaging aid	steel strap, wooden cover plate	
405925	Industrial Deck UDI 25 x 75	
amount	60	
load carrier	wire crate k	
packaging method	stacked	
packaging aid	steel strap	



Article No.	Article Name	Article Image
406031	Bolt Ø 16 x 70, galv.	
amount	4000	
load carrier	hardware box	
packaging method	40 bags, 100 per bag	
packaging aid	steel strap, wooden cover plate	
406092	Industrial Deck UDI 25 x 100	
amount	40	
load carrier	wire crate k	
packaging method	stacked	
packaging aid	steel strap, wooden cover plate	
406582	Stringer Frame UZF 200	
amount	24	
load carrier	post pallet RP 150	
packaging method	stacked	
packaging aid	steel strap, square timber	
406583	Stringer Frame UZF 250	
amount	24	
load carrier	post pallet RP 150	
packaging method	8 wide, 3 up	
packaging aid	steel strap	
406585	Steel Deck UDS 32 x 150 Public	
amount	24	
load carrier	post pallet USP 72	
packaging method	stacked	
packaging aid	steel strap, square timber	
406586	Steel Deck UDS 32 x 200 Public	
amount	24	
load carrier	post pallet USP 72	
packaging method	stacked	
packaging aid	steel strap	
406587	Steel Deck UDS 32 x 250 Public	
amount	24	
load carrier	post pallet USP 72	
packaging method	stacked	
packaging aid	steel strap or tension strap	

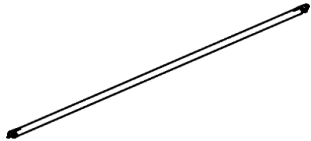
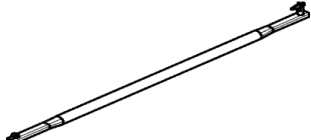

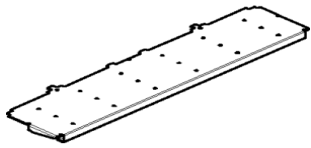
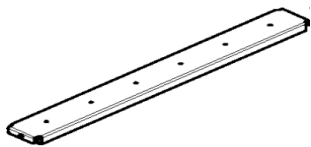
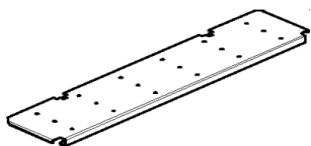
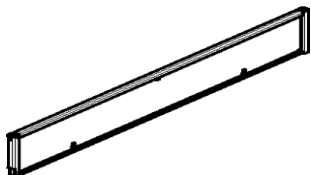
Article No.	Article Name	Article Image
406613	Ledger Brace UBL 104/100	
amount	225	
load carrier	post pallet RP 120	
packaging method		
packaging aid		
406624	Node Brace UBK 250/150	
amount	105	
load carrier	post pallet RP 150	
packaging method	15 wide, 7 up	
packaging aid	steel strap	
406630	Node Brace UBK 200/150	
amount	105	
load carrier	post pallet RP 150	
packaging method	stacked	
packaging aid	steel strap, square timber	
406880	Industrial Deck UDI 25 x 125	
amount	40	
load carrier	bundle	
packaging method	stacked	
packaging aid	steel strap, square timber	
406931	Horizontal Brace UBH 250/150	
amount	104	
load carrier	post pallet RP 150	
packaging method	13 wide, 8 up	
packaging aid	steel strap, square timber	
406965	Pavement Gantry UVG 104/240	
amount	10	
load carrier	bundle	
packaging method	lying	
packaging aid	steel strap, square timber	
406969	Node Brace UBK 72/100	
amount	105	
load carrier	post pallet RP 120	
packaging method		
packaging aid		

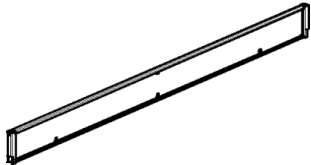
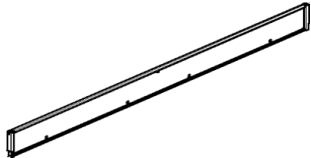
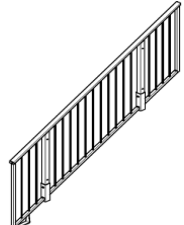

Article No.	Article Name	Article Image
407002	Industrial Deck UDI 25 x 150	
amount	40	
load carrier	bundle	
packaging method	stacked	
packaging aid	steel strap, square timber	
407050	Guardrail UPG 104	
amount	300	
load carrier	wire crate k	
packaging method	20 wide, 15 up	
packaging aid		
407162	Stringer Frame UZF 150	
amount	24	
load carrier	post pallet RP 120	
packaging method	stacked	
packaging aid	steel strap, square timber	
407178	End Guardrail Post UZE 200	
amount	24	
load carrier	post pallet RP 150	
packaging method	9 wide, 3 up	
packaging aid	steel strap	
407448	Stair Stringer UZS 250/150	
amount	16	
load carrier	post pallet RP 150	
packaging method	stacked	
packaging aid	steel strap	
407801	Shoring Brace UBS 150/100	
amount	135	
load carrier	post pallet RP 150	
packaging method	stacked	
packaging aid	steel strap, square timber	
407810	Shoring Brace UBS 150/150	
amount	135	
load carrier	post pallet RP 150	
packaging method	stacked	
packaging aid	steel strap, square timber	

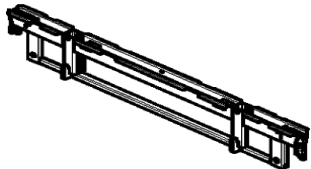
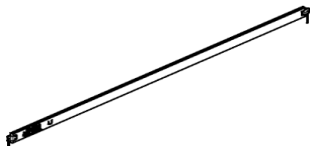
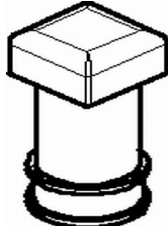
Article No.	Article Name	Article Image
407815	Horizontal Brace UBH 200/150	
amount	104	
load carrier	post pallet RP 150	
packaging method	13 wide, 8 up	
packaging aid	steel strap, square timber	
407867	Ledger Brace UBL 150/50	
amount	180	
load carrier	post pallet RP 120	
packaging method	15 wide, 12 up	
packaging aid	steel strap, square timber	
407930	Standard UVR 300 Public	
amount	56	
load carrier	post pallet RP 150	
packaging method	stacked	
packaging aid	steel strap	
407977	Gap Filler UZD 150 x 37	
amount	40	
load carrier	post pallet RP 120	
packaging method	stacked	
packaging aid	steel strap	
407981	Gap Filler UZD 150 x 16	
amount	32	
load carrier	post pallet RP 120	
packaging method	stacked	
packaging aid	steel strap, square timber	
407986	Gap Filler UZD 150 x 31	
amount	45	
load carrier	post pallet RP 120	
packaging method	stacked	
packaging aid	steel strap	
408000	Landing Brace UZB 150	
amount	45	
load carrier	post pallet RP 120	
packaging method	stacked	
packaging aid	steel strap, square timber	

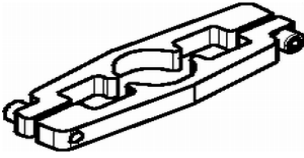
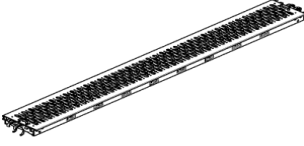
Article No.	Article Name	Article Image
408010	Gap Filler UZD 200 x 16	
amount	32	
load carrier	post pallet RP 150	
packaging method	stacked	
packaging aid	steel strap, square timber	
408011	Gap Filler UZD 250 x 16	
amount	32	
load carrier	post pallet RP 150	
packaging method	stacked	
packaging aid	steel strap, square timber	
408034	Landing Brace UZB 90°	
amount	300	
load carrier	wire crate k	
packaging method	loose	
packaging aid	steel strap, wooden cover plate	
408068	Toe Board Timber UPT 150/2	
amount	54	
load carrier	post pallet RP 120	
packaging method	18 wide, 3 up	
packaging aid	steel strap, square timber	
408114	Toe Board Timber UPT 200/2	
amount	54	
load carrier	post pallet RP 150	
packaging method	18 wide, 3 up	
packaging aid	steel strap, square timber	
408117	Toe Board Timber UPT 250/2	
amount	54	
load carrier	post pallet RP 150	
packaging method	18 wide, 3 up	
packaging aid	steel strap, square timber	
408120	Toe Board Timber UPT 300/2	
amount	54	
load carrier	post pallet RP 150	
packaging method	18 wide, 3 up	
packaging aid	steel strap, square timber	

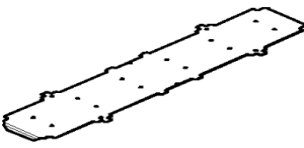
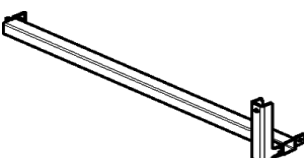
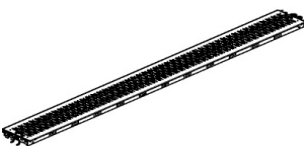
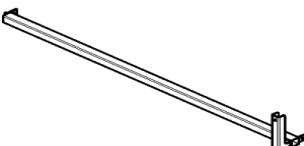
Article No.	Article Name	Article Image
408172	Landing Brace UZB 200	
amount	45	
load carrier	post pallet RP 150	
packaging method	stacked	
packaging aid	steel strap	
408179	Landing Brace UZB 250	
amount	45	
load carrier	post pallet RP 120	
packaging method	stacked	
packaging aid	steel strap	
408189	Stair Guardrail UZG 250/150	
amount	14	
load carrier	post pallet USP 72	
packaging method	stacked	
packaging aid	steel strap, tension strap	
408190	Landing Guardrail UZG 150	
amount	14	
load carrier	post pallet USP 104	
packaging method	stacked	
packaging aid	steel strap, tension strap	
408191	Landing Transom UZL 150	
amount	16	
load carrier	post pallet RP 120	
packaging method	stacked	
packaging aid	steel strap, square timber	
408204	Toe Board Timber UPT 400/2	
amount	54	
load carrier	post pallet RP 150	
packaging method	18 wide, 3 up	
packaging aid	steel strap, square timber	
408214	Guardrail Filler	
amount	200	
load carrier	hardware box	
packaging method	loose	
packaging aid	steel strap, wooden cover plate	

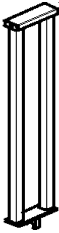
Article No.	Article Name	Article Image
408218	Guardrail Connector, Straight	
amount	300	
load carrier	hardware box	
packaging method	loose	
packaging aid	steel strap, wooden cover plate	
408380	Industrial Deck UDI 25 x 200	
amount	40	
load carrier	bundle	
packaging method	stacked	
packaging aid	steel strap, square timber, stacking device	
408387	Guardrail Connector, Corner	
amount	250	
load carrier	hardware box	
packaging method	loose	
packaging aid	steel strap, wooden cover plate	
408412	Landing Cover Plate UZD 150/25	
amount	50	
load carrier	post pallet RP 120	
packaging method	stacked	
packaging aid	steel strap	
408536	End Guardrail Post UZE 150	
amount	24	
load carrier	post pallet RP 120	
packaging method	9 wide, 3 up	
packaging aid	steel strap	
408540	Industrial Deck UDI 25 x 250	
amount	40	
load carrier	bundle	
packaging method	stacked	
packaging aid	steel strap, square timber, stacking device	
408544	End Guardrail Post UZE 250	
amount	24	
load carrier	post pallet RP 150	
packaging method	stacked	
packaging aid	steel strap, wooden strip between each layer	

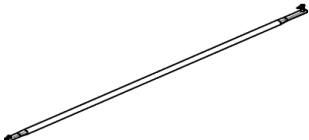
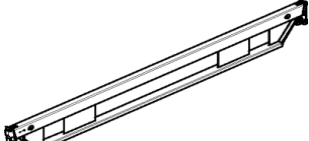
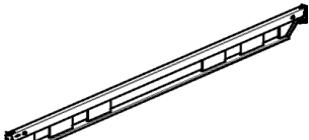
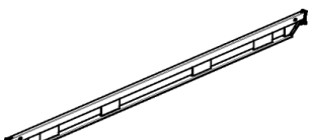
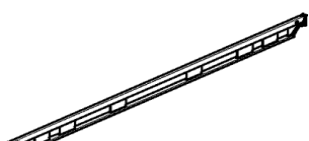
Article No.	Article Name	Article Image
408545	Guardrail Frame UZG 25	
amount	52	
load carrier	wire crate k	
packaging method	stacked	
packaging aid	steel strap, wooden cover plate	
408689	Industrial Deck UDI 25 x 300	
amount	40	
load carrier	bundle	
packaging method	stacked	
packaging aid	steel strap, square timber	
409034	Ledger Brace UBL 175/200	
amount	180	
load carrier	post pallet RP 150	
packaging method	15 wide, 12 up	
packaging aid	steel strap, square timber	
409107	Ledger UHV 150	
amount	54	
load carrier	post pallet RP 120	
packaging method	18 wide, 3 up	
packaging aid	steel strap, square timber	
409108	Ledger UHV 200	
amount	54	
load carrier	post pallet RP 150	
packaging method	18 wide, 3 up	
packaging aid	steel strap, square timber	
409109	Ledger UHV 250	
amount	54	
load carrier	post pallet RP 150	
packaging method	18 wide, 3 up	
packaging aid	steel strap, square timber	
409110	Ledger UHV 300	
amount	54	
load carrier	post pallet RP 150	
packaging method	18 wide, 3 up	
packaging aid	steel strap, square timber	

Article No.	Article Name	Article Image
409198	Stair Step UAR 100	
amount	150	
load carrier	wire crate k	
packaging method	stacked	
packaging aid	steel strap, square timber	
409208	End Step UAE 100	
amount	100	
load carrier	wire crate k	
packaging method	stacked	
packaging aid	steel strap	
409219	Stair Stringer UA 250/200	
amount	30	
load carrier	post pallet RP 150	
packaging method	stacked	
packaging aid	steel strap, square timber	
409563	Head Spindle Locking UJH	
amount	400	
load carrier	wire crate k	
packaging method	loose	
packaging aid	steel strap, wooden cover plate	
409755	Hatch UAF 75 x 100	
amount	9	
load carrier	wire crate k	
packaging method	stacked	
packaging aid	steel strap	
409764	UH Spigot	
amount	600	
load carrier	wire crate k	
packaging method	loose	
packaging aid	steel strap, wooden cover plate	
409783	Hatch UAF 50 x 75	
amount	20	
load carrier	wire crate k	
packaging method	stacked	
packaging aid	steel strap, wooden cover plate	

Article No.	Article Name	Article Image
409879	Ladder UAF 200, Alu	
amount	20	
load carrier	post pallet RP 150	
packaging method	stacked	
packaging aid	steel strap	
410072	Swing Ledger UPK 75	
amount	80	
load carrier	hardware box	
packaging method	stacked	
packaging aid	steel strap, wooden cover plate	
410073	Toeboard Steel UPY 100	
amount	160	
load carrier	wire crate k	
packaging method	4 layers, 40 per layer	
packaging aid	steel strap, wooden cover plate	
410076	Toeboard Steel UPY 104	
amount	160	
load carrier	wire crate k	
packaging method	4 layers, 40 per layer	
packaging aid	steel strap, wooden cover plate	
410160	Toeboard Steel UPY 150	
amount	120	
load carrier	post pallet RP 120	
packaging method	stacked	
packaging aid	steel strap, square timber	
410176	Toeboard Steel UPY 200	
amount	120	
load carrier	post pallet RP 120	
packaging method	stacked	
packaging aid	steel strap, square timber	
410208	Toeboard Steel UPY 250	
amount	120	
load carrier	post pallet RP 120	
packaging method	stacked	
packaging aid	steel strap, square timber	

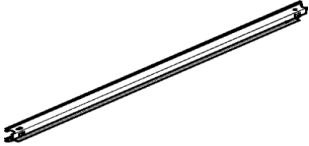
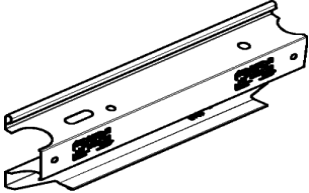
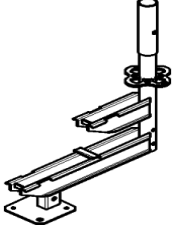
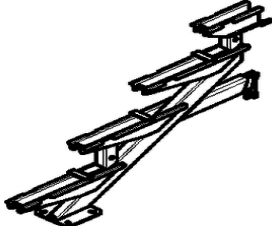
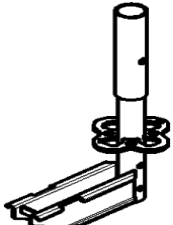
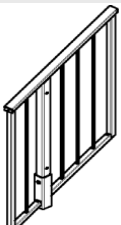
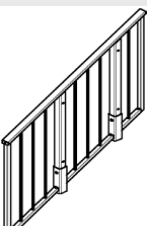
Article No.	Article Name	Article Image
410211	Toeboard Steel UPY 300	
amount	120	
load carrier	post pallet RP 150	
packaging method	stacked	
packaging aid	steel strap, square timber	
410213	Toeboard Steel UPY 50	
amount	360	
load carrier	wire crate k	
packaging method	stacked	
packaging aid	steel strap, square timber	
410242	Stair Stringer UZS 56/50	
amount	25	
load carrier	wire crate k	
packaging method	stacked	
packaging aid	steel strap, wooden cover plate	
410249	Stair Stringer UZS 110/83	
amount	15	
load carrier	wire crate k	
packaging method	stacked	
packaging aid	steel strap, wooden cover plate	
410258	Stair Stringer UZS 28/27	
amount	50	
load carrier	wire crate k	
packaging method	stacked	
packaging aid	steel strap, wooden cover plate	
410263	Stair Guardrail UZG 56/50	
amount	15	
load carrier	post pallet USP 72	
packaging method	stacked	
packaging aid	steel strap	
410270	Stair Guardrail UZG 110/83	
amount	14	
load carrier	post pallet USP 72	
packaging method	stacked	
packaging aid	steel strap	

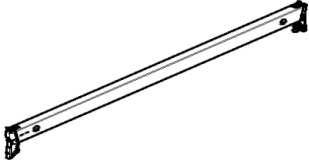
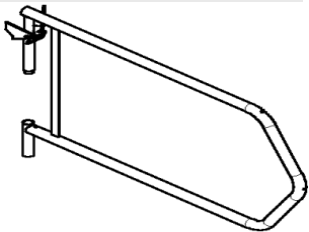
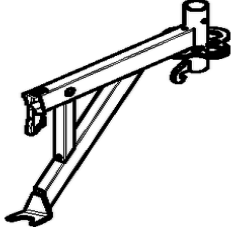
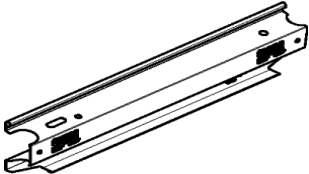
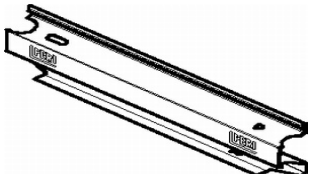
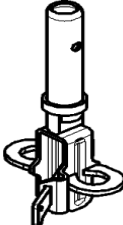
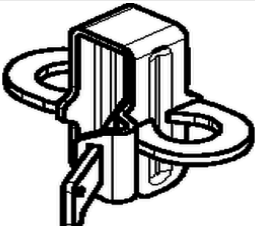
Article No.	Article Name	Article Image
410347	Ledger UH 125	
amount	100	
load carrier	wire crate k	
packaging method	20 wide, 5 up	
packaging aid	steel strap, wooden cover plate	
410478	Guardrail UPX 100	
amount	40	
load carrier	wire crate k	
packaging method	stacked	
packaging aid	steel strap, wooden cover plate	
410483	Console UCM 50-2	
amount	50	
load carrier	wire crate k	
packaging method	loose	
packaging aid	steel strap, wooden cover plate	
410514	Toeboard Steel UPY 75	
amount	280	
load carrier	wire crate k	
packaging method	4 layers, 70 per layer	
packaging aid	steel strap, wooden cover plate	
410526	Toeboard Steel UPY 72	
amount	280	
load carrier	wire crate k	
packaging method	4 layers, 70 per layer	
packaging aid	steel strap, wooden cover plate	
410792	Ledger to Ledger Coupler UHA Half w. Spigot	
amount	300	
load carrier	wire crate k	
packaging method	loose	
packaging aid	steel strap, wooden cover plate	
410793	Ledger to Ledger Coupler UHA Half	
amount	600	
load carrier	wire crate k	
packaging method	loose	
packaging aid	steel strap, wooden cover plate	

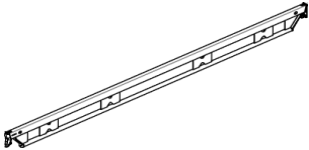
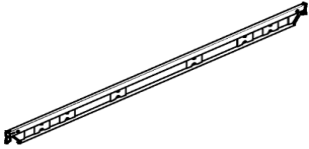
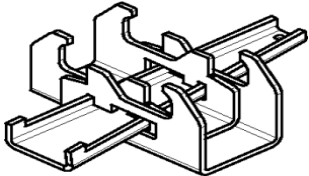
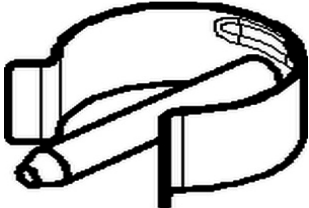
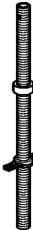
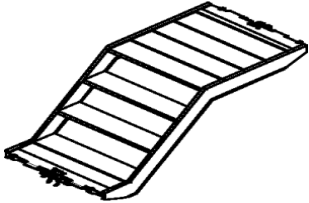
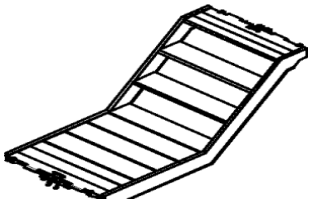
Article No.	Article Name	Article Image
410807	Horizontal Ledger UHV-L 250	
amount	57	
load carrier	post pallet RP 150	
packaging method	stacked	
packaging aid	steel strap, square timber	
410815	Horizontal Ledger UHV-L 300	
amount	57	
load carrier	post pallet RP 150	
packaging method	stacked	
packaging aid	steel strap, square timber	
411011	Deck Link Plate UDC	
amount	500	
load carrier	wire crate k	
packaging method	loose	
packaging aid	steel strap, wooden cover plate	
411053	Locking Pin Ø 48/57	
amount	6000	
load carrier	wire crate k	
packaging method	100 per bag	
packaging aid	steel strap, wooden cover plate	
411072	Section Spindle UJK 38-110/41	
amount	135	
load carrier	wire crate k	
packaging method	stacked	
packaging aid	steel strap, wooden cover plate	
411087	Staircase UAS 75 x 150/50 T, Alu	
amount	5	
load carrier	post pallet USP 72	
packaging method	stacked	
packaging aid	steel strap or tension strap	
411095	Staircase UAS 75 x 150/50 S, Alu	
amount	5	
load carrier	post pallet USP 72	
packaging method	stacked	
packaging aid	steel strap	

Article No.	Article Name	Article Image
411101	Bottom Sheeting UDP 75	
amount	20	
load carrier	wire crate k	
packaging method	stacked	
packaging aid	steel strap, wooden cover plate	
411103	Staircase UAS 75 x 150/100, Alu	
amount	7	
load carrier	post pallet USP 72	
packaging method	stacked	
packaging aid	steel strap or tension strap	
411117	Staircase UAS 75 x 250/200, Alu	
amount	6	
load carrier	post pallet USP 72	
packaging method	stacked	
packaging aid	steel strap or tension strap	
411124	Staircase UAS 75 x 300/200, Alu	
amount	6	
load carrier	post pallet USP 72	
packaging method	stacked	
packaging aid	steel strap or tension strap	
411128	Console UCM 75-2	
amount	40	
load carrier	wire crate k	
packaging method	stacked	
packaging aid	steel strap, wooden cover plate	
411686	Industrial Deck UDI 37.5 x 100	
amount	24	
load carrier	wire crate k	
packaging method	2 wide, 12 up	
packaging aid	steel strap, wooden cover plate	
411687	Industrial Deck UDI 37.5 x 75	
amount	36	
load carrier	wire crate k	
packaging method	3 wide, 12 up	
packaging aid	steel strap, wooden cover plate	

Article No.	Article Name	Article Image
411860	Industrial Deck UDI 37.5 x 125	
amount	48	
load carrier	bundle	
packaging method	3 wide, 16 up	
packaging aid	steel strap, square timber, dunnage	
411863	Industrial Deck UDI 37.5 x 150	
amount	30	
load carrier	bundle	
packaging method	stacked	
packaging aid	steel strap	
411864	Industrial Deck UDI 37.5 x 200	
amount	30	
load carrier	bundle	
packaging method	stacked	
packaging aid	steel strap	
411969	Industrial Deck UDI 37.5 x 300	
amount	30	
load carrier	bundle	
packaging method	stacked	
packaging aid	steel strap, square timber	
412012	Base Frame MDS	
amount	42	
load carrier	post pallet RP 120	
packaging method	14 layers, 3 per layer	
packaging aid	steel strap, each layer plugged into each other	
412034	Intermediate Frame MDS 50	
amount	28	
load carrier	post pallet RP 120	
packaging method	2 wide, 14 up	
packaging aid	steel strap, square timber, each layer plugged into each other	
412059	End Frame MDS 50	
amount	20	
load carrier	post pallet RP 120	
packaging method	10 layers, 2 per layer	
packaging aid	steel strap, square timber	

Article No.	Article Name	Article Image
412676	Console UCM 50 with Spigot	
amount	50	
load carrier	wire crate k	
packaging method	loose	
packaging aid	steel strap, wooden cover plate	
412678	Console UCM 75 with Spigot	
amount	40	
load carrier	wire crate k	
packaging method	stacked	
packaging aid	steel strap, wooden cover plate	
412690	Console UCM 50 with half Rosett	
amount	50	
load carrier	wire crate k	
packaging method	loose	
packaging aid	steel strap, wooden cover plate	
412693	Console UCM 75 with half Rosett	
amount	40	
load carrier	wire crate k	
packaging method	stacked	
packaging aid	steel strap, wooden cover plate	
412717	Console Bracket Brace UCM	
amount	72	
load carrier	post pallet RP 120	
packaging method	stacked	
packaging aid	steel strap, square timber	
412765	Node Brace UBK 125/200	
amount	105	
load carrier	post pallet RP 150	
packaging method	15 wide, 7 up	
packaging aid	steel strap	
412809	Bottom Sheeting UDP 100	
amount	20	
load carrier	wire crate k	
packaging method	stacked	
packaging aid	steel strap, wooden cover plate	

Article No.	Article Name	Article Image
412926	Node Brace UBK 100/200	
amount	105	
load carrier	post pallet RP 150	
packaging method	15 wide, 7 up	
packaging aid	steel strap	
413050	Guardrail Holder UPW-1	
amount	100	
load carrier	hardware box	
packaging method	loose	
packaging aid	steel strap, wooden cover plate	
413228	Staircase UAS 75x75/50	
amount	6	
load carrier	wire crate k	
packaging method	stacked	
packaging aid		
413358	Corner Sheeting UDC 100	
amount	16	
load carrier	post pallet RP 120	
packaging method	stacked	
packaging aid	steel strap	
413726	Flange Coupler UEC	
amount	250	
load carrier	hardware box	
packaging method	loose	
packaging aid	steel strap, wooden cover plate	
414124	Ledger UH 72 Plus	
amount	230	
load carrier	wire crate k	
packaging method	32 wide, 7 up + 6	
packaging aid	steel strap, wooden cover plate	
414148	Corner Sheeting UDC 75	
amount	25	
load carrier	wire crate k	
packaging method	stacked	
packaging aid	steel strap, wooden cover plate	

Article No.	Article Name	Article Image
414179	Stair Step UAR 125	
amount	75	
load carrier	post pallet RP 120	
packaging method	stacked	
packaging aid	steel strap	
414180	End Step UAE 125	
amount	100	
load carrier	post pallet RP 120	
packaging method	stacked	
packaging aid	steel strap	
414536	Staircase UAS 75 x 150/100 S, Alu	
amount	7	
load carrier	post pallet USP 72	
packaging method	stacked	
packaging aid	steel strap	
414595	Ledger UH 50 Plus	
amount	300	
load carrier	wire crate k	
packaging method	21 wide, 7 up + 3, x2	
packaging aid	steel strap, wooden cover plate	
414613	Ledger UH 25 Plus	
amount	600	
load carrier	wire crate k	
packaging method	loose	
packaging aid	steel strap, wooden cover plate	
414629	Ledger UH 75 Plus	
amount	230	
load carrier	wire crate k	
packaging method	32 wide, 7 up + 6	
packaging aid	steel strap, wooden cover plate	
414632	Ledger UH 100 Plus	
amount	150	
load carrier	wire crate k	
packaging method	21 wide, 7 up + 3	
packaging aid	steel strap, wooden cover plate	

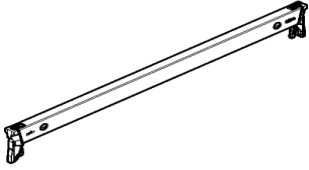
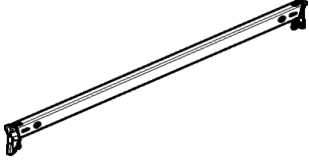
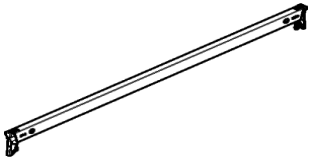
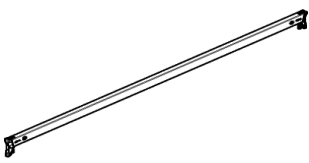
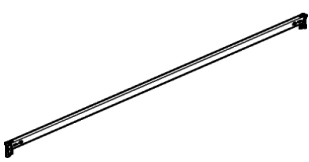
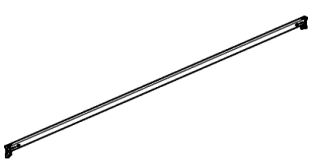
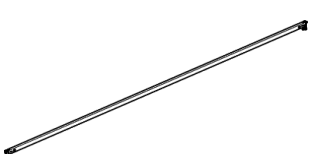
Article No.	Article Name	Article Image
414635	Ledger UH 104 Plus	
amount	150	
load carrier	wire crate k	
packaging method	21 wide, 7 up + 3	
packaging aid	steel strap, wooden cover plate	
414638	Ledger UH 125 Plus	
amount	100	
load carrier	wire crate k	
packaging method	20 wide, 5 up	
packaging aid	steel strap, square timber, wooden cover plate	
414641	Ledger UH 150 Plus	
amount	108	
load carrier	post pallet RP 120	
packaging method	18 wide, 6 up	
packaging aid	steel strap	
414645	Ledger UH 200 Plus	
amount	108	
load carrier	post pallet RP 150	
packaging method	18 wide, 6 up	
packaging aid	steel strap	
414648	Ledger UH 250 Plus	
amount	108	
load carrier	post pallet RP 150	
packaging method	18 wide, 6 up	
packaging aid	steel strap	
414651	Ledger UH 300 Plus	
amount	108	
load carrier	post pallet RP 150	
packaging method	18 wide, 6 up	
packaging aid	steel strap	
414654	Ledger UH 400 Plus	
amount	108	
load carrier	post pallet RP 150	
packaging method	18 wide, 6 up	
packaging aid	steel strap	

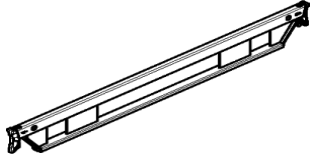
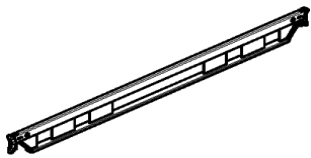
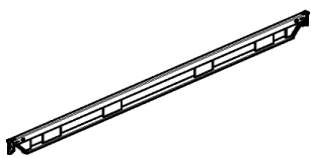
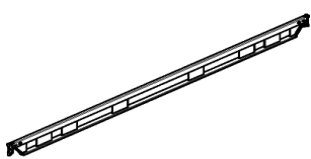
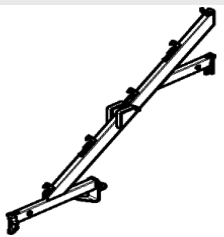
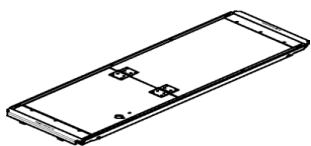
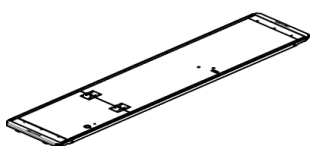
Article No.	Article Name	Article Image
414681	Ledger UHV 150 Plus	
amount	54	
load carrier	post pallet RP 120	
packaging method	18 wide, 3 up	
packaging aid	steel strap	
414687	Ledger UHV 200 Plus	
amount	54	
load carrier	post pallet RP 150	
packaging method	18 wide, 3 up	
packaging aid	steel strap	
414691	Ledger UHV 250 Plus	
amount	54	
load carrier	post pallet RP 150	
packaging method	18 wide, 3 up	
packaging aid	steel strap	
414695	Ledger UHV 300 Plus	
amount	54	
load carrier	post pallet RP 150	
packaging method	18 wide, 3 up	
packaging aid	steel strap	
414731	Stair Stringer UA 125/100	
amount	30	
load carrier	post pallet RP 120	
packaging method	3 wide, 10 up	
packaging aid	steel strap	
414811	Access Deck UAL-2, 64 x 200/3	
amount	8	
load carrier	post pallet RP 150	
packaging method	stacked	
packaging aid	steel strap	
414812	Access Deck w. Ladder UAL-2, 64 x 300/3	
amount	8	
load carrier	post pallet RP 150	
packaging method	stacked	
packaging aid	steel strap	

Article No.	Article Name	Article Image
414818	H-Brace UBH Flex 100/100	
amount	104	
load carrier	post pallet RP 120	
packaging method	13 wide, 8 up	
packaging aid	steel strap	
414819	H-Brace UBH Flex 250/100	
amount	104	
load carrier	post pallet RP 150	
packaging method	13 wide, 8 up	
packaging aid	steel strap	
414820	H-Brace UBH Flex 200/100	
amount	104	
load carrier	post pallet RP 150	
packaging method	13 wide, 8 up	
packaging aid	steel strap	
414821	H-Brace UBH Flex 150/100	
amount	104	
load carrier	post pallet RP 120	
packaging method	13 wide, 8 up	
packaging aid	steel strap	
414825	Access Deck w. Ladder UAL-2, 64 x 250/3	
amount	8	
load carrier	post pallet RP 150	
packaging method	stacked	
packaging aid	steel strap	
414892	H-Brace UBH Flex 300/100	
amount	104	
load carrier	post pallet RP 150	
packaging method	13 wide, 8 up	
packaging aid	steel strap	
414896	H-Brace UBH Flex 250/75	
amount	104	
load carrier	post pallet RP 150	
packaging method	13 wide, 8 up	
packaging aid	steel strap	

Article No.	Article Name	Article Image
414900	H-Brace UBH Flex 300/75	
amount	104	
load carrier	post pallet RP 150	
packaging method	13 wide, 8 up	
packaging aid	steel strap	
414904	H-Brace UBH Flex 125/125	
amount	104	
load carrier	post pallet RP 120	
packaging method	13 wide, 8 up	
packaging aid	steel strap	
414908	H-Brace UBH Flex 150/125	
amount	104	
load carrier	post pallet RP 120	
packaging method	13 wide, 8 up	
packaging aid	steel strap	
414912	H-Brace UBH Flex 150/150	
amount	104	
load carrier	post pallet RP 120	
packaging method	13 wide, 8 up	
packaging aid	steel strap	
414916	H-Brace UBH Flex 200/200	
amount	104	
load carrier	post pallet RP 150	
packaging method	13 wide, 8 up	
packaging aid	steel strap	
414920	H-Brace UBH Flex 250/200	
amount	104	
load carrier	post pallet RP 150	
packaging method	13 wide, 8 up	
packaging aid	steel strap	
414924	H-Brace UBH Flex 300/200	
amount	104	
load carrier	post pallet RP 150	
packaging method	13 wide, 8 up	
packaging aid	steel strap	

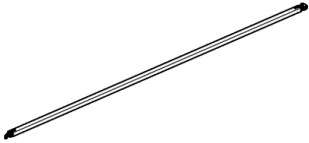
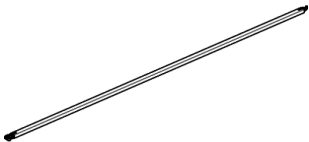
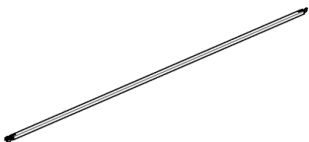
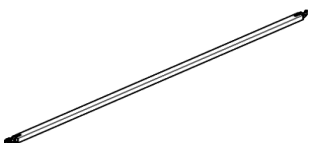
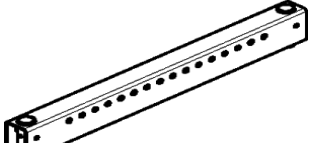
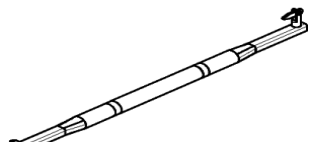
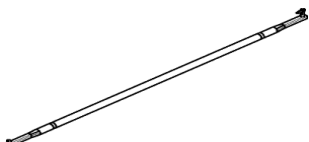
Article No.	Article Name	Article Image
414928	H-Brace UBH Flex 250/250	
amount	104	
load carrier	post pallet RP 150	
packaging method	13 wide, 8 up	
packaging aid	steel strap	
414932	H-Brace UBH Flex 300/250	
amount	104	
load carrier	post pallet RP 150	
packaging method	13 wide, 8 up	
packaging aid	steel strap	
414936	H-Brace UBH Flex 300/300	
amount	104	
load carrier	post pallet RP 150	
packaging method	13 wide, 8 up	
packaging aid	steel strap	
414996	H-Brace UBH Flex 250/125	
amount	104	
load carrier	post pallet RP 150	
packaging method	13 wide, 8 up	
packaging aid	steel strap	
415018	LGS Ledger URL 100/14	
amount	45	
load carrier	wire crate k	
packaging method	9 wide, 5 up	
packaging aid	steel strap, wooden cover plate	
415156	Ledger Brace UBL 100/50	
amount	300	
load carrier	wire crate k	
packaging method	0	
packaging aid		
415157	Ledger Brace UBL 100/200	
amount	180	
load carrier	post pallet RP 120	
packaging method	15 wide, 12 up	
packaging aid	steel strap, square timber	

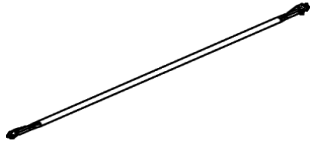
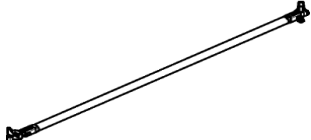
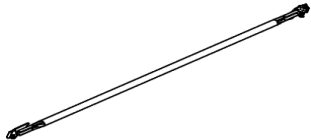
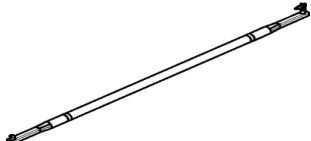
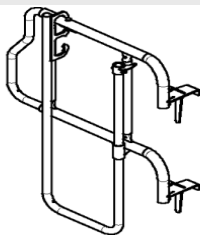
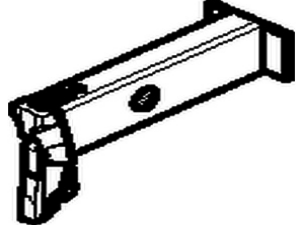
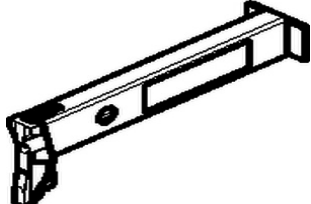
Article No.	Article Name	Article Image
415291	Shoring Brace UBS 200/150	
amount	135	
load carrier	post pallet RP 150	
packaging method	15 wide, 9 up	
packaging aid	steel strap	
415354	Node Brace UBK 125/100	
amount	105	
load carrier	post pallet RP 120	
packaging method	15 wide, 7 up	
packaging aid	steel strap	
415504	Shoring Brace UBS 200/100	
amount	135	
load carrier	post pallet RP 150	
packaging method	15 wide, 9 up	
packaging aid	steel strap	
415513	Ledger Brace UBL 100/150	
amount	180	
load carrier	post pallet RP 120	
packaging method	15 wide, 12 up	
packaging aid		
415655	End Guardrail in Advance UPA Rosett	
amount	9	
load carrier	wire crate k	
packaging method	stacked	
packaging aid	steel strap, wooden cover plate	
415959	Support UC 25	
amount	500	
load carrier	wire crate k	
packaging method	loose	
packaging aid	steel strap, wooden cover plate	
415962	Support UC 37.5	
amount	400	
load carrier	wire crate k	
packaging method	loose	
packaging aid	steel strap, wooden cover plate	

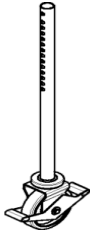
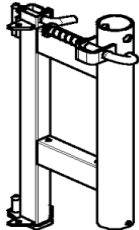
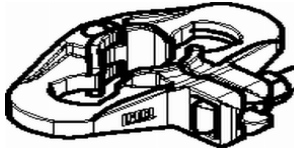
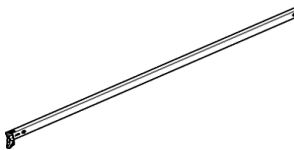
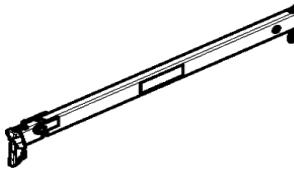
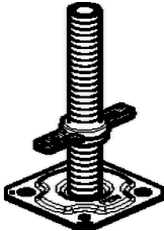
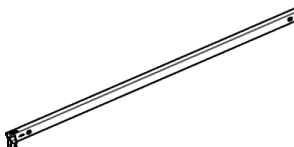

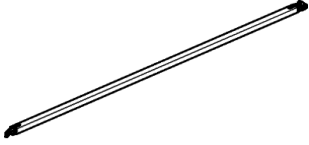
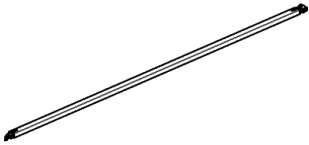
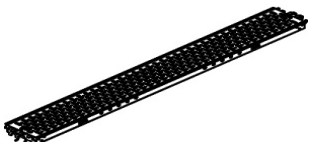

Article No.	Article Name	Article Image
416176	Transportation Wheel UEW	
amount	50	
load carrier	wire crate k	
packaging method	loose	
packaging aid	steel strap, wooden cover plate	
416193	Connection Transportation Wheel UER	
amount	50	
load carrier	wire crate k	
packaging method	loose	
packaging aid	steel strap, wooden cover plate	
416306	Rosett Coupler UEV 180°	
amount	300	
load carrier	hardware box	
packaging method	loose	
packaging aid	steel strap, wooden cover plate	
416356	Ledger UH 225 Plus	
amount	108	
load carrier	post pallet RP 150	
packaging method	18 wide, 6 up	
packaging aid	steel strap	
416695	Swing Ledger UPK 100	
amount	150	
load carrier	hardware box	
packaging method	loose	
packaging aid	steel strap, wooden cover plate	
416762	Adj. Base Plate UJB 38-36/17	
amount	200	
load carrier	wire crate k	
packaging method	stacked	
packaging aid	steel strap, wooden cover plate	
417032	Ledger UH 175 Plus	
amount	108	
load carrier	post pallet RP 150	
packaging method	18 wide, 6 up	
packaging aid	steel strap	

Article No.	Article Name	Article Image
417194	Base Standard UVB 49	
amount	126	
load carrier	wire crate k	
packaging method	14 wide, 9 up	
packaging aid	steel strap, wooden cover plate	
417195	Top Standard UVH 125	
amount	56	
load carrier	post pallet RP 120	
packaging method	8 wide, 7 up	
packaging aid	steel strap	
417196	Base Standard UVB 135 Plus	
amount	48	
load carrier	post pallet RP 120	
packaging method	8 wide, 6 up	
packaging aid	steel strap	
417197	Top Standard UVH 165 Plus	
amount	48	
load carrier	post pallet RP 120	
packaging method	8 wide, 6 up	
packaging aid	steel strap	
417689	Ledger Brace UBL 225/200	
amount	180	
load carrier	post pallet RP 150	
packaging method	15 wide, 15 up	
packaging aid		
417743	Handle Lock UJS Plus	
amount	400	
load carrier	wire crate k	
packaging method	loose	
packaging aid	steel strap, wooden cover plate	
418022	Stopper URA-2	
amount	200	
load carrier	hardware box	
packaging method	loose	
packaging aid	steel strap, wooden cover plate	

Article No.	Article Name	Article Image
423483	Horizontal Brace UBH 300/200	
amount	104	
load carrier	post pallet RP 150	
packaging method	13 wide, 8 up	
packaging aid	steel strap, square timber	
423580	Shoring Brace UBS 300/150	
amount	135	
load carrier	post pallet RP 150	
packaging method	15 wide, 9 up	
packaging aid	steel strap	
423584	Shoring Brace UBS 300/100	
amount	135	
load carrier	post pallet RP 150	
packaging method	15 wide, 9 up	
packaging aid	steel strap	
423588	Shoring Brace UBS 250/150	
amount	135	
load carrier	post pallet RP 150	
packaging method	15 wide, 9 up	
packaging aid	steel strap	
423592	Shoring Brace UBS 250/100	
amount	135	
load carrier	post pallet RP 150	
packaging method	15 wide, 9 up	
packaging aid	steel strap	
423694	Toeboard Steel UPY 150, galv.	
amount	120	
load carrier	post pallet RP 120	
packaging method	stacked	
packaging aid	square timber	
423698	TOEBOARD STEEL UPY 250 GALV.	
amount	120	
load carrier	post pallet RP 150	
packaging method	10 pieces -- 3 wide, 4 up	
packaging aid	steel strap, square timber	

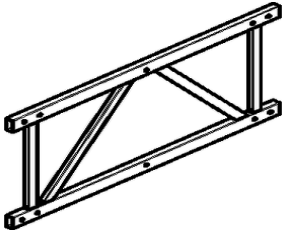
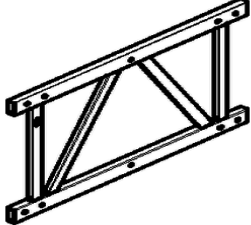
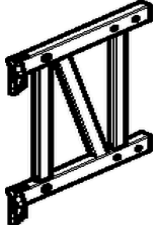

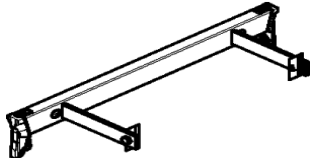
Article No.	Article Name	Article Image
423700	TOEBOARD STEEL UPY 300 GALV.	
amount	120	
load carrier	post pallet RP 150	
packaging method	10 pieces -- 3 wide, 4 up	
packaging aid	steel strap, square timber	
423771	Steel Deck UDG 25 x 250	
amount	45	
load carrier	bundle	
packaging method	5 wide, 9 up	
packaging aid	steel strap, square timber	
423941	Castor UEW 30 with Spindle	
amount	40	
load carrier	wire crate k	
packaging method	stacked	
packaging aid	steel strap, wooden cover plate	
424097	H-Brace UBH Flex 200/150	
amount	104	
load carrier	post pallet RP 150	
packaging method	13 wide, 8 up	
packaging aid	steel strap	
424101	H-Brace UBH Flex 250/150	
amount	104	
load carrier	post pallet RP 150	
packaging method	13 wide, 8 up	
packaging aid	steel strap	
424105	H-Brace UBH Flex 300/150	
amount	104	
load carrier	post pallet RP 150	
packaging method	13 wide, 8 up	
packaging aid	steel strap	
424109	Steel Deck UDG 25 x 200	
amount	45	
load carrier	bundle	
packaging method	5 wide, 9 up	
packaging aid	steel strap, square timber	

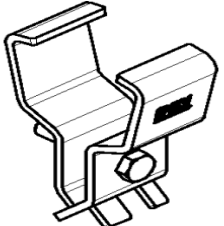
Article No.	Article Name	Article Image
424112	Steel Deck UDG 25 x 150	
amount	45	
load carrier	bundle	
packaging method	5 wide, 9 up	
packaging aid	steel strap, square timber	
424115	Steel Deck UDG 25 x 125	
amount	45	
load carrier	bundle	
packaging method	5 wide, 9 up	
packaging aid	steel strap, square timber	
424118	Steel Deck UDG 25 x 100	
amount	36	
load carrier	wire crate k	
packaging method	stacked	
packaging aid	steel strap, wooden cover plate	
424121	Steel Deck UDG 25 x 75	
amount	60	
load carrier	wire crate k	
packaging method	stacked	
packaging aid	steel strap, wooden cover plate	
424124	Steel Deck UDG 25 x 50	
amount	78	
load carrier	wire crate k	
packaging method	stacked	
packaging aid	steel strap, wooden cover plate	
424170	Node Brace UBK 75/200	
amount	105	
load carrier	post pallet RP 150	
packaging method	15 wide, 7 up	
packaging aid	steel strap	
424781	Additional Element ULS 150 Flex	
amount	25	
load carrier	post pallet RP 120	
packaging method	stacked	
packaging aid	steel strap	

Article No.	Article Name	Article Image
424790	Additional Element ULS 125 Flex	
amount	25	
load carrier	post pallet RP 120	
packaging method	stacked	
packaging aid	steel strap, wooden cover plate	
424795	Additional Element ULS 100 Flex	
amount	25	
load carrier	wire crate k	
packaging method	stacked	
packaging aid	steel strap, wooden cover plate	
424805	End Element ULS 50 Flex	
amount	60	
load carrier	wire crate k	
packaging method	stacked	
packaging aid	steel strap, wooden cover plate	
424806	Connector ULS Flex	
amount	50	
load carrier	wire crate k	
packaging method	stacked	
packaging aid	steel strap, wooden cover plate	
424813	Ladder Connection UAC-2	
amount	50	
load carrier	wire crate k	
packaging method	stacked	
packaging aid	steel strap, wooden cover plate	
424915	Steel Deck UDG 25 x 300	
amount	40	
load carrier	bundle	
packaging method	5 wide, 8 up	
packaging aid	steel strap, square timber	
425166	LGS Keder Connector URK	
amount	1000	
load carrier	wire crate k	
packaging method	loose	
packaging aid	steel strap, wooden cover plate	

Article No.	Article Name	Article Image
425172	Toeboard Wood UPT-3 150	
amount	54	
load carrier	post pallet RP 120	
packaging method	18 wide, 3 up	
packaging aid	steel strap, square timber	
425173	Toeboard Wood UPT-3 200	
amount	54	
load carrier	post pallet RP 150	
packaging method	18 wide, 3 up	
packaging aid	steel strap, square timber	
425174	Toeboard Wood UPT-3 250	
amount	54	
load carrier	post pallet RP 150	
packaging method	18 wide, 3 up	
packaging aid	steel strap, square timber	
425175	Toeboard Wood UPT-3 300	
amount	54	
load carrier	post pallet RP 150	
packaging method	18 wide, 3 up	
packaging aid	steel strap, square timber	
425631	Platform MDS 125	
amount	15	
load carrier	post pallet RP 150	
packaging method	3 wide, 5 up	
packaging aid	steel strap	
425672	Safety Entry Gate UPS 75	
amount	20	
load carrier	wire crate k	
packaging method	stacked	
packaging aid		
426009	LGS Keder Connector URV	
amount	500	
load carrier	wire crate k	
packaging method	loose	
packaging aid	steel strap, wooden cover plate	

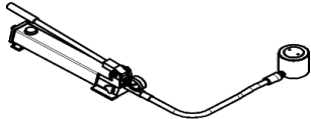
Article No.	Article Name	Article Image
426051	LGS Ridge Rail URK 150	
amount	60	
load carrier	post pallet RP 120	
packaging method	stacked	
packaging aid	steel strap	
426071	LGS Keder Rail URK 600	
amount	81	
load carrier	post pallet RP 150	
packaging method	9 wide, 9 up	
packaging aid	steel strap	
426314	Access Deck UAL-3 75x250/3	
amount	12	
load carrier	post pallet USP 104	
packaging method	stacked	
packaging aid		
426318	Ladder Flex UEL with Hook	
amount	20	
load carrier	post pallet RP 150	
packaging method	stacked	
packaging aid		
426435	Head Spindle TR 110-80/55	
amount	10	
load carrier	wire crate k	
packaging method	5 wide, 2 up	
packaging aid	steel strap, wooden cover plate	
426436	Lowering Jack HD	
amount	20	
load carrier	wire crate k	
packaging method	10 wide, 2 up, drilled out	
packaging aid	steel strap, wooden cover plate	
426437	Connector UJC	
amount	24	
load carrier	wire crate k	
packaging method	stacked	
packaging aid	steel strap, wooden cover plate	

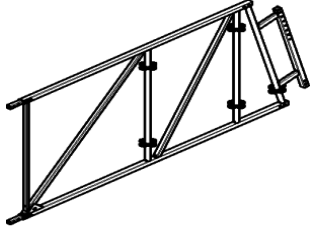
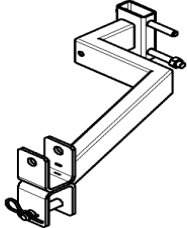
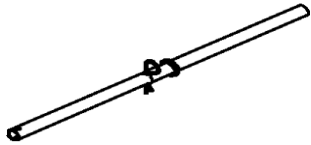
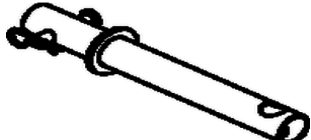
Article No.	Article Name	Article Image
426438	Hydraulic-Unit HD	
amount	1	
load carrier	aluminium box	
packaging method	loose	
packaging aid	steel strap	
426453	ROSETT COUPLER UEV 90°	
amount	300	
load carrier	hardware box	
packaging method	loose	
packaging aid		
426466	LGS Rudge Guardrail URH	
amount	15	
load carrier	wire crate k	
packaging method	loose	
packaging aid	steel strap, wooden cover plate	
426483	LGS Eave Element URB 300/150	
amount	20	
load carrier	bundle	
packaging method	loose	
packaging aid	steel strap, square timber	
426486	LGS Reel Connector URG	
amount	60	
load carrier	wire crate k	
packaging method	loose	
packaging aid	steel strap, wooden cover plate	
426487	LGS Crank URG	
amount	100	
load carrier	hardware box	
packaging method	stacked	
packaging aid	steel strap, wooden cover plate	
426488	LGS Handle URG	
amount	120	
load carrier	hardware box	
packaging method	loose	
packaging aid	steel strap, wooden cover plate	

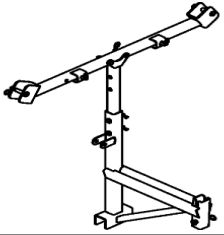
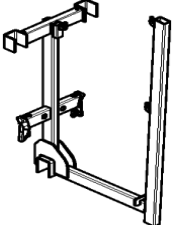
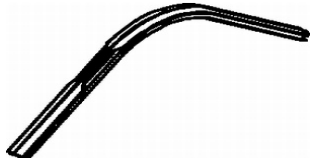
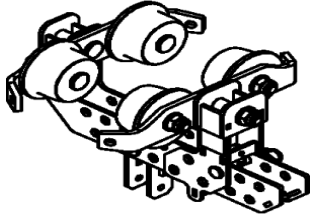
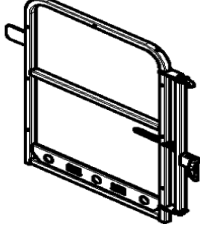
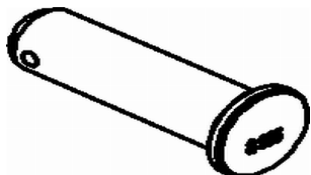
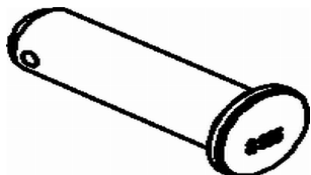
Article No.	Article Name	Article Image
426489	LGS Ridge Console URH	
amount	10	
load carrier	post pallet RP 120	
packaging method	stacked	
packaging aid	steel strap	
426490	LGS Console URH	
amount	9	
load carrier	wire crate k	
packaging method	stacked	
packaging aid	steel strap, wooden cover plate	
426491	LGS Eave Rail URK	
amount	45	
load carrier	post pallet RP 120	
packaging method	9 wide, 5 up	
packaging aid	steel strap	
426497	Trolley UFS 20	
amount	16	
load carrier	wire crate k	
packaging method	8 wide, 2 up	
packaging aid	steel strap, wooden cover plate	
426675	Safety Entry Gate UPS 100	
amount	10	
load carrier	post pallet RP 120	
packaging method	stacked	
packaging aid	roof batton	
426868	Toeboard Wood UPT-3 104	
amount	60	
load carrier	wire crate k	
packaging method	60 wide, 3 up	
packaging aid	steel strap, square timber	
427468	Bolt Ø 24 x 55, galv.	
amount	2000	
load carrier	hardware box	
packaging method	40 bags, 50 per bag	
packaging aid	steel strap, wooden cover plate	

Article No.	Article Name	Article Image
427500	LGS Keder Rail URK 300	
amount	81	
load carrier	post pallet RP 150	
packaging method	9 wide, 9 up	
packaging aid	steel strap	
427501	LGS Keder Rail URK 150	
amount	81	
load carrier	post pallet RP 120	
packaging method	9 wide, 9 up	
packaging aid	steel strap	
428334	Ridge Bar HD UR 150°	
amount	64	
load carrier	post pallet RP 150	
packaging method	8 wide, 8 up	
packaging aid		
428817	Tie Yoke URU	
amount	216	
load carrier	hardware box	
packaging method	18x4 wide, 3 up	
packaging aid		
428823	Suspension Tie Connector URU	
amount	40	
load carrier	hardware box	
packaging method	8 wide, 5 up	
packaging aid		
429272	Steel Deck EDS 33X300	
amount	48	
load carrier	bundle	
packaging method	3 wide, 16 up	
packaging aid	steel strap, square timber, dunnage	
429314	Head Frame EVH 67	
amount	14	
load carrier	wire crate k	
packaging method	2 wide, 7 up	
packaging aid	steel strap, square timber	

Article No.	Article Name	Article Image
429435	Tie Rod Extension URU	
amount	250	
load carrier	hardware box	
packaging method	loose	
packaging aid		
429498	Toeboard Wood UPF 150	
amount	42	
load carrier	post pallet RP 120	
packaging method	14 wide, 3 up	
packaging aid	steel strap, square timber	
429500	Toeboard Wood UPF 200	
amount	42	
load carrier	post pallet RP 120	
packaging method	14 wide, 3 up	
packaging aid	steel strap, square timber	
429502	Toeboard Wood UPF 250	
amount	42	
load carrier	post pallet RP 120	
packaging method	14 wide, 3 up	
packaging aid	steel strap, square timber	
429504	Toeboard Wood UPF 300	
amount	42	
load carrier	post pallet RP 120	
packaging method	14 wide, 3 up	
packaging aid	steel strap, square timber	
429947	Toeboard Steel UPY 67	
amount	400	
load carrier	wire crate k	
packaging method	4 layers, 70 per layer	
packaging aid	steel strap, square timber	
429982	Ledger UH 67 Plus	
amount	256	
load carrier	wire crate k	
packaging method	32 wide, 8 up	
packaging aid	steel strap, wooden cover plate	

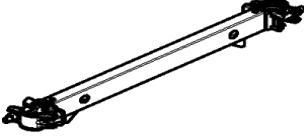
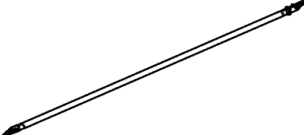
Article No.	Article Name	Article Image
430009	Coupler Ledger UHC 67	
amount	100	
load carrier	wire crate k	
packaging method	stacked	
packaging aid	steel strap, wooden cover plate	
430162	Face Brace EBF 150/200	
amount	135	
load carrier	post pallet RP 120	
packaging method	15 wide, 9 up	
packaging aid	steel strap, square timber	
430171	Face Brace EBF 200/200	
amount	135	
load carrier	post pallet RP 120	
packaging method	15 wide, 9 up	
packaging aid	steel strap, square timber	
430180	Face Brace EBF 250/200	
amount	135	
load carrier	post pallet RP 120	
packaging method	15 wide, 9 up	
packaging aid	steel strap, square timber	
430189	Face Brace EBF 300/200	
amount	135	
load carrier	post pallet RP 120	
packaging method	15 wide, 9 up	
packaging aid	steel strap, square timber	
430191	Guardrail EPG 67	
amount	713	
load carrier	wire crate k	
packaging method	25 layers á 28 or 29 pcs per Layer, shifted stacked	
packaging aid	steel strap, wooden cover plate	
430193	Guardrail EPG 100	
amount	437	
load carrier	wire crate k	
packaging method	stacked	
packaging aid	steel strap, wooden cover plate	

Article No.	Article Name	Article Image
430195	Guardrail EPG 150	
amount	289	
load carrier	post pallet RP 120	
packaging method	17 wide, 17 up	
packaging aid	steelstrap, square timber	
430197	Guardrail EPG 200	
amount	289	
load carrier	post pallet RP 120	
packaging method	17 wide, 17 up	
packaging aid	steelstrap, square timber	
430199	Guardrail EPG 250	
amount	289	
load carrier	post pallet RP 120	
packaging method	17 wide, 17 up	
packaging aid	steelstrap, square timber	
430201	Guardrail EPG 300	
amount	289	
load carrier	post pallet RP 120	
packaging method	17 wide, 17 up	
packaging aid	steelstrap, square timber	
430225	End Guardrail EPF 100	
amount	28	
load carrier	wire crate k	
packaging method	loose	
packaging aid	steel strap, wooden cover plate	
430228	End Guardrail EPF 67	
amount	35	
load carrier	wire crate k	
packaging method	upright	
packaging aid	steel strap, wooden cover plate	
430233	End Guardrail EPF 33	
amount	50	
load carrier	wire crate k	
packaging method	loose	
packaging aid	steel strap, wooden cover plate	

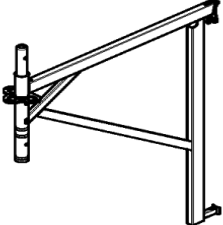
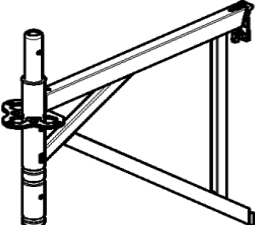
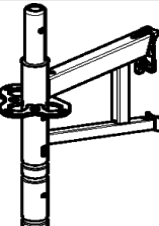
Article No.	Article Name	Article Image
430309	Combi Deck EDW 300	
amount	8	
load carrier	post pallet RP 120	
packaging method	stacked	
packaging aid	steel strap, edge protection	
430313	Combi Deck EDW 250	
amount	8	
load carrier	post pallet RP 120	
packaging method	stacked	
packaging aid	steel strap, edge protection	
430317	Combi Deck EDW 200	
amount	8	
load carrier	post pallet RP 120	
packaging method	stacked	
packaging aid	steel strap, edge protection	
430321	Combi Deck EDW 150	
amount	8	
load carrier	post pallet RP 120	
packaging method	stacked	
packaging aid	steel strap, edge protection	
430365	Consol Bracket ECM 100	
amount	20	
load carrier	post pallet RP 120	
packaging method	stacked	
packaging aid	steel strap	
430372	Consol Bracket ECM 67	
amount	25	
load carrier	wire crate k	
packaging method	loose	
packaging aid	steel strap, wooden cover plate	
430378	Consol Bracket ECM 33	
amount	50	
load carrier	wire crate k	
packaging method	loose	
packaging aid	steel strap, wooden cover plate	

Article No.	Article Name	Article Image
430385	Connection Protect Panel EPC	
amount	114	
load carrier	wire crate k	
packaging method	6 wide, 19 up	
packaging aid	steel strap, wooden cover plate	
430390	Support UC 33	
amount	400	
load carrier	hardware box	
packaging method	loose	
packaging aid	steel strap, wooden cover plate	
430419	LADDER EAL	
amount	20	
load carrier	post pallet RP 120	
packaging method	stacked	
packaging aid	steel strap	
430425	Ladder Access EAW-L 300	
amount	8	
load carrier	post pallet RP 120	
packaging method	stacked	
packaging aid	steel strap, edge protection	
430426	Access Deck EAW 200	
amount	8	
load carrier	post pallet RP 120	
packaging method	stacked	
packaging aid	steel strap, edge protection	
430431	Ladder Access EAW-L 250	
amount	8	
load carrier	post pallet RP 120	
packaging method	stacked	
packaging aid	steel strap, edge protection	
430434	Guardrail Coupler EPR	
amount	1000	
load carrier	wire crate k	
packaging method	loose	
packaging aid	steel strap, wooden cover plate	

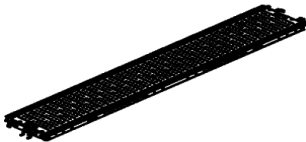
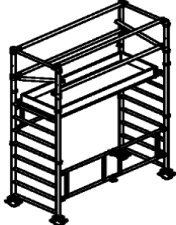
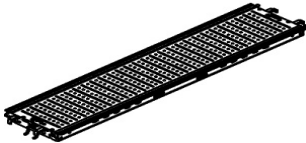
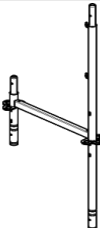
Article No.	Article Name	Article Image
430438	Steel Deck EDS 33X250	
amount	48	
load carrier	bundle	
packaging method	3 wide, 16 up	
packaging aid	steel strap, square timber, dunnage	
430441	Steel Deck EDS 33X200	
amount	48	
load carrier	bundle	
packaging method	3 wide, 16 up	
packaging aid	steel strap, square timber, dunnage	
430444	Steel Deck EDS 33X150	
amount	48	
load carrier	bundle	
packaging method	3 wide, 16 up	
packaging aid	steel strap, square timber, dunnage	
430445	STEEL DECK EDS 33X150	
amount	24	
load carrier	bundle	
packaging method	8 layers, 3 per layer (mutual)	
packaging aid		
430448	Steel Deck EDS 33X100	
amount	30	
load carrier	wire crate k	
packaging method	2 wide, 13 up + 4 at the side	
packaging aid	steel strap, wooden cover plate	
430450	Steel Deck EDS 33X 67	
amount	45	
load carrier	wire crate k	
packaging method	3 wide, 13 up + 6 at the side	
packaging aid	steel strap, wooden cover plate	
430466	Easy Frame EVF 67	
amount	20	
load carrier	post pallet ESP 67	
packaging method	10 wide, 2 up	
packaging aid	steel strap	

Article No.	Article Name	Article Image
430476	Advance Guardrail UPA 67	
amount	22	
load carrier	post pallet USP 72	
packaging method	stacked	
packaging aid	steel strap, tension strap	
430481	Tube EVR 150	
amount	130	
load carrier	post pallet RP 120	
packaging method	13 wide, 10 up	
packaging aid	steel strap, square timber	
430507	CONNECTION TRANSPORT.WHEEL MDS	
amount	40	
load carrier	wire crate k	
packaging method	2 layers, wooden plate between each layer, 20 per layer, upright	
packaging aid	wooden plate	
430512	Guardrail Post EVP	
amount	240	
load carrier	wire crate k	
packaging method	stacked	
packaging aid	steel strap, wooden cover plate	
430518	Base Frame EVB 67	
amount	30	
load carrier	post pallet USP 72	
packaging method	stacked	
packaging aid	steel strap	
430562	Guardrail Holder EPW	
amount	850	
load carrier	hardware box	
packaging method	loose	
packaging aid	steel strap, wooden cover plate	
430577	ADVANCE GUARDRAIL UPA 75	
amount	22	
load carrier	post pallet USP 72	
packaging method	stacked, hook up	
packaging aid		

Article No.	Article Name	Article Image
430583	Advance Guardrail UPA 100	
amount	22	
load carrier	post pallet USP 104	
packaging method	stacked	
packaging aid	steel strap, tension strap	
430592	END GUARDRAIL EPF 75	
amount	35	
load carrier	wire crate k	
packaging method	32 upright, 3 in the front	
packaging aid		
430681	UH-SPIGOT-2	
amount	600	
load carrier	wire crate k	
packaging method	loose	
packaging aid		
430684	LEDG.-LEDG.COUPL. UHA-2 SPIGOT	
amount	300	
load carrier	wire crate k	
packaging method	loose	
packaging aid		
430866	Assembly Deck PERI UP Flex 150	
amount	20	
load carrier	bundle	
packaging method	2 wide, 10 up	
packaging aid	steel strap, square timber, dunnage	
430916	Assembly Deck PERI UP Flex 200	
amount	20	
load carrier	bundle	
packaging method	2 wide, 10 up	
packaging aid	steel strap, square timber, dunnage	
430929	Assembly Deck PERI UP Flex 250	
amount	20	
load carrier	bundle	
packaging method	2 wide, 10 up	
packaging aid	steel strap, square timber, dunnage	

Article No.	Article Name	Article Image
431726	COUPLER BRACE UBC-2 150/200	
amount	84	
load carrier	post pallet RP 150	
packaging method	7 layers, 12 per layer	
packaging aid		
431806	FRAME MDS 100 K	
amount	22	
load carrier	post pallet USP 72	
packaging method	stacked	
packaging aid	steel strap	
431869	LGS LEDGER URL 75/14	
amount	50	
load carrier	wire crate k	
packaging method	5 layers, 9 per layer + 5	
packaging aid		
431995	Ledger UH-2 25	
amount	600	
load carrier	wire crate k	
packaging method	loose	
packaging aid	steel strap, wooden cover plate	
431998	Ledger UH-2 50	
amount	300	
load carrier	wire crate k	
packaging method	21 wide, 7 up + 3, x2	
packaging aid	steel strap, wooden cover plate	
432004	Ledger UH-2 100	
amount	150	
load carrier	wire crate k	
packaging method	21 wide, 7 up + 3	
packaging aid	steel strap, wooden cover plate	
432007	Ledger UH-2 125	
amount	100	
load carrier	wire crate k	
packaging method	20 wide, 5 up	
packaging aid	steel strap, square timber, wooden cover plate	

Article No.	Article Name	Article Image
432010	Ledger UH-2 150	
amount	108	
load carrier	post pallet RP 120	
packaging method	18 wide, 6 up	
packaging aid	steel strap	
432013	Ledger UH-2 175	
amount	108	
load carrier	post pallet RP 150	
packaging method	18 wide, 6 up	
packaging aid	steel strap	
432016	Ledger UH-2 200	
amount	108	
load carrier	post pallet RP 150	
packaging method	18 wide, 6 up	
packaging aid	steel strap	
432019	Ledger UH-2 225	
amount	108	
load carrier	post pallet RP 150	
packaging method	18 wide, 6 up	
packaging aid	steel strap	
432022	Ledger UH-2 300	
amount	108	
load carrier	post pallet RP 150	
packaging method	18 wide, 6 up	
packaging aid	steel strap	
432025	Ledger UH-2 250	
amount	108	
load carrier	post pallet RP 150	
packaging method	18 wide, 6 up	
packaging aid	steel strap	
432123	Top Standard UVH-2 50	
amount	200	
load carrier	wire crate k	
packaging method	stacked	
packaging aid	steel strap, wooden cover plate	

Article No.	Article Name	Article Image
432194	Top Standard UVH-2 100	
amount	81	
load carrier	wire crate k	
packaging method	stacked	
packaging aid	steel strap, wooden cover plate	
432196	Top Standard UVH-2 125	
amount	56	
load carrier	post pallet RP 120	
packaging method	8 wide, 7 up	
packaging aid	steel strap	
432198	Top Standard UVH-2 150	
amount	56	
load carrier	post pallet RP 120	
packaging method	8 wide, 7 up	
packaging aid	steel strap	
432200	Top Standard UVH-2 200	
amount	56	
load carrier	post pallet RP 150	
packaging method	8 wide, 7 up	
packaging aid	steel strap	
432202	Top Standard UVH-2 250	
amount	56	
load carrier	post pallet RP 150	
packaging method	8 wide, 7 up	
packaging aid	steel strap	
432213	Ledger UH-2 75	
amount	230	
load carrier	wire crate k	
packaging method	32 wide, 7 up + 6	
packaging aid	steel strap, wooden cover plate	
432479	Steel Deck UDG-2 25x50	
amount	96	
load carrier	wire crate k	
packaging method	6 stacks, 15 per stack +6	
packaging aid		

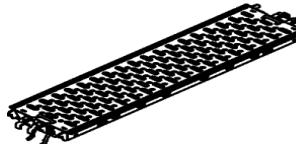
Article No.	Article Name	Article Image
432479	Steel deck UDG-2 25x50	
amount	96	
load carrier	wire crate k	
packaging method	6 wide, 15 up, horizontal stacked + 6 pcs vertical	
packaging aid	steel strap, wooden cover plate	
432488	Steel deck UDG-2 25x75	
amount	64	
load carrier	wire crate k	
packaging method	4 wide, 15 up, horizontal stacked + 6 pcs vertical	
packaging aid	steel strap, wooden cover plate	
432492	Steel deck UDG-2 25x100	
amount	45	
load carrier	wire crate k	
packaging method	3 wide, 15 up, horizontal stacked	
packaging aid	steel strap, wooden cover plate	
		
432502	Steel deck UDG-2 25x125	
amount	88	
load carrier	bundle	
packaging method	4 wide, 22 up, horizontal stacked	
packaging aid	steel strap, square timber	
432505	Steel deck UDG-2 25x150	
amount	88	
load carrier	bundle	
packaging method	4 wide, 22 up, horizontal stacked	
packaging aid	steel strap, square timber	
432505	Steel Deck UDG-2 25x150	
amount	88	
load carrier	bundle	
packaging method	4 wide, 22 up, roof batton after 11 layers (lenght = 1,03)	
packaging aid	roof batton	
432508	Steel deck UDG-2 25x200	
amount	72	
load carrier	bundle	
packaging method	4 wide, 18 up, horizontal stacked	
packaging aid	steel strap, square timber	

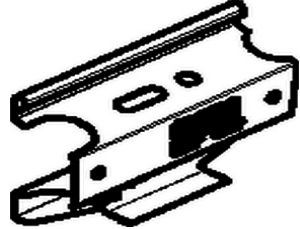
Article No.	Article Name	Article Image
432511	Steel deck UDG-2 25x250	
amount	72	
load carrier	bundle	
packaging method	4 wide, 18 up, horizontal stacked	
packaging aid	steel strap, square timber	
432515	Steel deck UDG-2 25x300	
amount	56	
load carrier	bundle	
packaging method	4 wide, 14 up, horizontal stacked	
packaging aid	steel strap, square timber	
432592	TOEBOARD STEEL UPY 25	
amount	840	
load carrier	wire crate k	
packaging method	4 layers, wooden plate between each layer, 10 per stack, 210 per layer	
packaging aid	wooden plate	
432771	Ledger Brace UBL-2 100/50	
amount	300	
load carrier	wire crate k	
packaging method	19wide, 15 up + 15	
packaging aid	steel strap, wooden cover plate	
432773	Ledger Brace UBL-2 100/100	
amount	180	
load carrier	post pallet RP 120	
packaging method	12 layers, 15 per layer, roof batton after 2 layers	
packaging aid	roof batton	
432773	Ledger Brace UBL-2 100/100	
amount	225	
load carrier	post pallet RP 120	
packaging method	15 wide, 15 up	
packaging aid	steel strap, square timber	
432775	Ledger Brace UBL-2 100/150	
amount	180	
load carrier	post pallet RP 120	
packaging method	15 wide, 12 up	
packaging aid	steel strap, square timber	

Article No.	Article Name	Article Image
432777	Ledger Brace UBL-2 100/200	
amount	180	
load carrier	post pallet RP 120	
packaging method	15 wide, 12 up	
packaging aid	steel strap, square timber	
432779	Ledger Brace UBL-2 150/50	
amount	180	
load carrier	post pallet RP 120	
packaging method	15 wide, 12 up	
packaging aid	steel strap, square timber	
432781	Ledger Brace UBL-2 150/100	
amount	225	
load carrier	post pallet RP 120	
packaging method	15 wide, 15 up	
packaging aid	steel strap, square timber	
432783	Ledger Brace UBL-2 150/150	
amount	180	
load carrier	post pallet RP 150	
packaging method	15 wide, 12 up	
packaging aid	steel strap, square timber	
432785	Ledger Brace UBL-2 150/200	
amount	225	
load carrier	post pallet RP 150	
packaging method	15 wide, 15 up	
packaging aid	steel strap, square timber	
432787	Ledger Brace UBL-2 175/200	
amount	180	
load carrier	post pallet RP 150	
packaging method	15 wide, 12 up	
packaging aid	steel strap, square timber	
432789	Ledger Brace UBL-2 200/50	
amount	180	
load carrier	post pallet RP 150	
packaging method	15 wide, 12 up	
packaging aid	steel strap, square timber	

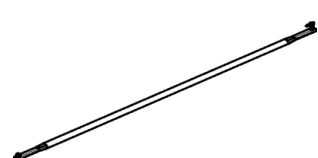
Article No.	Article Name	Article Image
432791	Ledger Brace UBL-2 200/100	
amount	225	
load carrier	post pallet RP 150	
packaging method	15 wide, 15 up	
packaging aid	steel strap, square timber	
432793	Ledger Brace UBL-2 200/150	
amount	180	
load carrier	post pallet RP 150	
packaging method	15 wide, 12 up	
packaging aid	steel strap, square timber	
432795	Ledger Brace UBL-2 200/200	
amount	195	
load carrier	post pallet RP 150	
packaging method	15 wide, 13 up	
packaging aid	steel strap, square timber	
432797	Ledger Brace UBL-2 225/50	
amount	180	
load carrier	post pallet RP 150	
packaging method	15 wide, 12 up	
packaging aid	steel strap, square timber	
432808	Ledger Brace UBL-2 225/100	
amount	225	
load carrier	post pallet RP 150	
packaging method	15 wide, 15 up	
packaging aid	steel strap, square timber	
432810	Ledger Brace UBL-2 225/200	
amount	180	
load carrier	post pallet RP 150	
packaging method	15 wide, 15 up	
packaging aid	steel strap, square timber	
432812	Ledger Brace UBL-2 250/100	
amount	225	
load carrier	post pallet RP 150	
packaging method	15 wide, 15 up	
packaging aid	steel strap, square timber	

Article No.	Article Name	Article Image
432814	Ledger Brace UBL-2 250/150	
amount	180	
load carrier	post pallet RP 150	
packaging method	15 wide, 12 up	
packaging aid	steel strap, square timber	
432816	Ledger Brace UBL-2 250/200	
amount	180	
load carrier	post pallet RP 150	
packaging method	15 wide, 12 up	
packaging aid	steel strap, square timber	
432827	Ledger Brace UBL-2 300/ 50	
amount	180	
load carrier	post pallet RP 150	
packaging method	15 wide, 12 up	
packaging aid	steel strap, square timber	
432829	Ledger Brace UBL-2 300/100	
amount	180	
load carrier	post pallet RP 150	
packaging method	15 wide, 12 up	
packaging aid	steel strap, square timber	
432831	Ledger Brace UBL-2 300/150	
amount	165	
load carrier	post pallet RP 150	
packaging method		
packaging aid	steel strap, square timber	
432833	Ledger Brace UBL-2 300/200	
amount	165	
load carrier	post pallet RP 150	
packaging method		
packaging aid	steel strap, square timber	
432990	Access Deck UAA 75x200	
amount	12	
load carrier	post pallet USP 104	
packaging method	stacked	
packaging aid		



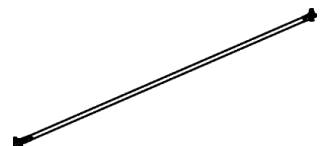

Article No.	Article Name	Article Image
432993	Access Deck UAA 75x150	
amount	12	
load carrier	post pallet USP 104	
packaging method	stacked	
packaging aid		
433314	Ladder Deck UAA 75x250-L	
amount	12	
load carrier	post pallet USP 104	
packaging method	stacked	
packaging aid		
433315	Ladder Deck UAA 75x300-L	
amount	12	
load carrier	post pallet USP 104	
packaging method	stacked	
packaging aid		
433418	Node Brace UBK-2 75/200	
amount	105	
load carrier	post pallet RP 150	
packaging method	15 wide, 7 up	
packaging aid	steel strap, square timber	
433421	Node Brace UBK-2 100/200	
amount	105	
load carrier	post pallet RP 150	
packaging method	15 wide, 7 up	
packaging aid	steel strap, square timber	
433424	Node Brace UBK-2 125/100	
amount	105	
load carrier	post pallet RP 120	
packaging method	15 wide, 7 up	
packaging aid	steel strap, square timber	
433427	Node Brace UBK-2 125/200	
amount	105	
load carrier	post pallet RP 150	
packaging method	15 wide, 7 up	
packaging aid	steel strap, square timber	

Article No.	Article Name	Article Image
433430	Node Brace UBK-2 150/100	
amount	105	
load carrier	post pallet RP 150	
packaging method	15 wide, 7 up	
packaging aid	steel strap, square timber	
433433	Node Brace UBK-2 150/150	
amount	105	
load carrier	post pallet RP 150	
packaging method	15 wide, 7 up	
packaging aid	steel strap, square timber	
433436	Node Brace UBK-2 150/200	
amount	105	
load carrier	post pallet RP 150	
packaging method	15 wide, 7 up	
packaging aid	steel strap, square timber	
433439	Node Brace UBK-2 200/100	
amount	105	
load carrier	post pallet RP 150	
packaging method	15 wide, 7 up	
packaging aid	steel strap, square timber	
433442	Node Brace UBK-2 200/150	
amount	105	
load carrier	post pallet RP 150	
packaging method	15 wide, 7 up	
packaging aid	steel strap, square timber	
433445	Node Brace UBK-2 200/200	
amount	105	
load carrier	post pallet RP 150	
packaging method	15 wide, 7 up	
packaging aid	steel strap, square timber	
433448	Node Brace UBK-2 250/100	
amount	105	
load carrier	post pallet RP 150	
packaging method	15 wide, 7 up	
packaging aid	steel strap, square timber	

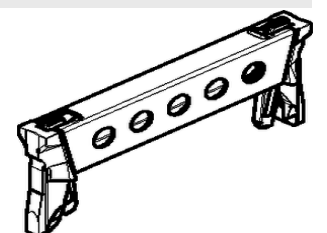
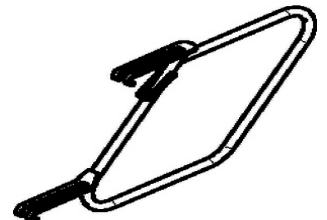

Article No.	Article Name	Article Image
433451	Node Brace UBK-2 250/150	
amount	105	
load carrier	post pallet RP 150	
packaging method	15 wide, 7 up	
packaging aid	steel strap, square timber	
433454	Node Brace UBK-2 250/200	
amount	105	
load carrier	post pallet RP 150	
packaging method	15 wide, 7 up	
packaging aid	steel strap, square timber	
433457	Node Brace UBK-2 300/100	
amount	105	
load carrier	post pallet RP 150	
packaging method	15 wide, 7 up	
packaging aid	steel strap, square timber	
433460	Node Brace UBK-2 300/150	
amount	105	
load carrier	post pallet RP 150	
packaging method	15 wide, 7 up	
packaging aid	steel strap, square timber	
433463	Node Brace UBK-2 300/200	
amount	105	
load carrier	post pallet RP 150	
packaging method	15 wide, 7 up	
packaging aid	steel strap, square timber	
433543	Stair Guardrail UAH-2	
amount	25	
load carrier	wire crate k	
packaging method	stacked offset	
packaging aid		
433900	Ledger UH-2 33	
amount	600	
load carrier	wire crate k	
packaging method	stacked	
packaging aid	steel strap, wooden cover plate	

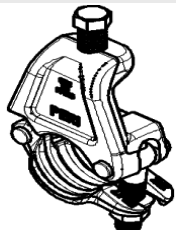
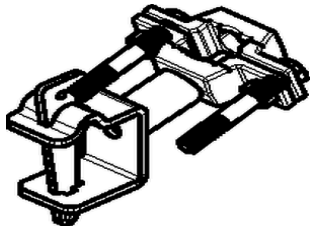

Article No.	Article Name	Article Image
433903	Ledger UH-2 67	
amount	230	
load carrier	wire crate k	
packaging method	32 wide, 7 up + 6	
packaging aid	steel strap, wooden cover plate	
434005	Console Bracket UCB 25	
amount	125	
load carrier	wire crate k	
packaging method	13 layers, 9 per layer (mutual) +8	
packaging aid		
434102	Advance Guardrail UPA-2 75	
amount	22	
load carrier	post pallet USP 72	
packaging method	stacked, hook up	
packaging aid		
434104	Advance Guardrail UPA-2 100	
amount	22	
load carrier	post pallet USP 72	
packaging method	stacked, hook up	
packaging aid		
434108	Adapter Hanging Scaffold UEH	
amount	500	
load carrier	wire crate k	
packaging method	loose	
packaging aid		
434204	Flange Coupler UEF	
amount	250	
load carrier	hardware box	
packaging method	loose	
packaging aid		
434520	Ladder Connector Ledger UAM-S	
amount	200	
load carrier	hardware box	
packaging method	loose	
packaging aid		

Article No.	Article Name	Article Image
434527	Ladder Connector Ledger UAM-W	
amount	200	
load carrier	hardware box	
packaging method	loose	
packaging aid		
434537	Corner Sheeting UDC 50	
amount	60	
load carrier	wire crate k	
packaging method	2 layers, 30 per layer, each 15 upright on the right and left side	
packaging aid	steel strap, wooden plate between each layer, wooden cover plate	

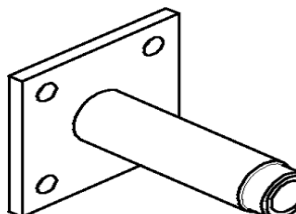
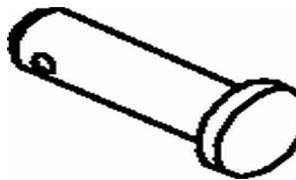
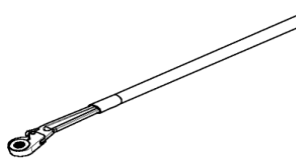
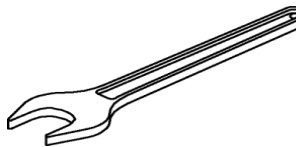
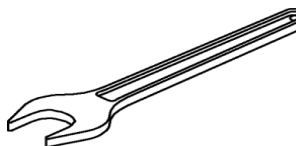
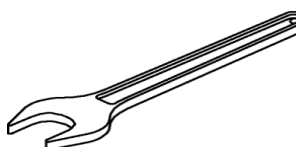
Article No.	Article Name	Article Image
326120	Guardrail Post KG	
amount	1	
load carrier	loose	
packaging method	loose	
packaging aid	connected to scaffold jack with steel strap	
326230	BOLT ANCHOR SLEEVE M 24	
amount	800	
load carrier	wire crate k	
packaging method	loose	
packaging aid	steel strap, wooden cover plate	
327170	Pin Ø 16 x 42, galv.	
amount	3000	
load carrier	hardware box	
packaging method	loose	
packaging aid	steel strap, wooden cover plate	
327180	Ratchet Lever SW 19	
amount	1	
load carrier	loose	
packaging method	loose	
packaging aid		
327210	Spanner SW 80, for SB	
amount	1	
load carrier	loose	
packaging method	loose	
packaging aid		
327211	Spanner SW 46, for SB	
amount	1	
load carrier	loose	
packaging method	loose	
packaging aid		
327213	Spanner SW 70, for SB	
amount	1	
load carrier	loose	
packaging method	loose	
packaging aid		

Article No.	Article Name	Article Image
329440	Lag Screw DIN 571 6 x 20, galv.	
amount	1000	
load carrier	hardware box	
packaging method	loose	
packaging aid	steel strap, wooden cover plate	
415150	Anchor Positioning Stud M24 x 65, galv.	
amount	1000	
load carrier	hardware box	
packaging method	loose	
packaging aid	steel strap, wooden cover plate	

Article No.	Article Name	Article Image
330005	Tie Rod DW 15, l = 0.50 m	
amount	1000	
load carrier	hardware box	
packaging method	10 per bundle, stacked	
packaging aid	steel strap, wooden cover plate	
330010	Tie Rod DW 15, l = 0.85 m	
amount	1000	
load carrier	post pallet RP 120	
packaging method	10 per bundle, stacked	
packaging aid	steel strap, square timber	
330020	Tie Rod DW 15, l = 1.70 m	
amount	500	
load carrier	post pallet RP 120	
packaging method	10 per bundle, stacked	
packaging aid	steel strap, square timber	
330070	Hex. Nut DW 15 SW 30/50, galv.	
amount	1000	
load carrier	hardware box	
packaging method	20 bags, 50 per bag	
packaging aid	steel strap, wooden cover plate	
330090	Hex. Nut DW 15 SW 30/108, galv.	
amount	1000	
load carrier	hardware box	
packaging method	20 bags, 50 per bag	
packaging aid	steel strap, wooden cover plate	
330100	Wingnut DW 15, galv.	
amount	1000	
load carrier	hardware box	
packaging method	loose	
packaging aid	steel strap, wooden cover plate	
330110	Wingnut Counterplate DW 15, galv.	
amount	500	
load carrier	hardware box	
packaging method	loose	
packaging aid	steel strap, wooden cover plate	

Article No.	Article Name	Article Image
330130	Cam Nut DW 15, galv.	
amount	1000	
load carrier	hardware box	
packaging method	20 bags, 50 per bag	
packaging aid	steel strap, wooden cover plate	
330140	Counterplate DW 15, 120 x 120 x 15	
amount	600	
load carrier	hardware box	
packaging method	10 layers, 60 per layer	
packaging aid	steel strap, wooden cover plate	
330150	Tie Rod B 15, l = 0.30 m	
amount	10 per bundle	
load carrier	hardware box	
packaging method	stacked	
packaging aid	steel strap	
330160	Tie Rod DW 15, l = 6.00 m	
amount	10 per bundle	
load carrier	post pallet RP 150	
packaging method	stacked	
packaging aid	steel strap	
330170	Tie Rod DW 15, l = 1.50 m	
amount	500	
load carrier	post pallet RP 120	
packaging method	10 per bundle, stacked	
packaging aid	steel strap, square timber	
330180	Tie Rod DW 15, l = 2.00 m	
amount	500	
load carrier	post pallet RP 120	
packaging method	10 per bundle, stacked	
packaging aid	steel strap, square timber	
330190	Three Wingnut DW 15, galv.	
amount	1000	
load carrier	hardware box	
packaging method	loose	
packaging aid	steel strap, wooden cover plate	

Article No.	Article Name	Article Image
330370	Wingnut Pivot Plate DW 15, galv.	
amount	300	
load carrier	hardware box	
packaging method	loose	
packaging aid	steel strap, wooden cover plate	
330400	Coupling Nut M 30/DW 26, galv.	
amount	200	
load carrier	hardware box	
packaging method	stacked	
packaging aid	steel strap, wooden cover plate	
330420	Counterplate DW 26, 120 x 120 x 20	
amount	600	
load carrier	hardware box	
packaging method	10 layers, 60 per layer	
packaging aid	steel strap, wooden cover plate	
330440	Spherical Nut DW 15, galv.	
amount	500	
load carrier	hardware box	
packaging method	loose	
packaging aid	steel strap, wooden cover plate	
330460	Pretension Jack for DW 15/20/26	
amount	1	
load carrier	sheet box	
packaging method	loose	
packaging aid		
330480	Tie Rod DW 15, l = 1.00 m	
amount	1000	
load carrier	post pallet RP 120	
packaging method	10 per bundle, stacked	
packaging aid	steel strap, square timber	
330490	Tie Rod DW 15, l = 1.20 m	
amount	500	
load carrier	post pallet RP 120	
packaging method	10 per bundle, stacked	
packaging aid	steel strap, square timber	

Article No.	Article Name	Article Image
330550	Hex. Nut DW 15 SW 30/50, weldable	
amount	1000	
load carrier	hardware box	
packaging method	loose	
packaging aid		
330580	Hex. Nut DW 20 SW 36/60, weldable	
amount	1000	
load carrier	hardware box	
packaging method	20 bags, 50 per bag	
packaging aid	steel strap, wooden cover plate	
330590	Hex. Nut DW 20 SW 36/110, weldable	
amount	1000	
load carrier	hardware box	
packaging method	20bags, 50 per bag	
packaging aid	steel strap, wooden cover plate	
330641	Tie Rod DW 20, L=1.0m	
amount	300	
load carrier	hardware box	
packaging method		
packaging aid		
330710	Tie Rod DW 15, l = 2.50 m	
amount	300	
load carrier	post pallet RP 150	
packaging method	10 per bundle, stacked	
packaging aid	steel strap, square timber	
330720	Tie Rod DW 15, l = 3.00 m	
amount	300	
load carrier	post pallet RP 150	
packaging method	10 per bundle, stacked	
packaging aid	steel strap, square timber	
330830	Counterplate DW 20, 120 x 120 x 20	
amount	600	
load carrier	hardware box	
packaging method	10 layers, 60 per layer	
packaging aid	steel strap, wooden cover plate	

Article No.	Article Name	Article Image
330940	Climbing Cone-2 M36/DW 26, galv.	
amount	250	
load carrier	hardware box	
packaging method	loose	
packaging aid	steel strap, wooden cover plate	
330970	Hex. Coupler DW 26 SW 46/80, weldable	
amount	1000	
load carrier	hardware box	
packaging method	loose	
packaging aid		
330980	Hex. Coupler DW 26 SW 46/150, weldable	
amount	800	
load carrier	hardware box	
packaging method	loose	
packaging aid		
330990	Wingnut DW 20, galv.	
amount	1000	
load carrier	hardware box	
packaging method	loose	
packaging aid	steel strap, wooden cover plate	
331070	Tie Rod Wrench 15, galv.	
amount	1	
load carrier	loose	
packaging method	loose	
packaging aid		
331220	CLIMBING CONE-2 M24/DW15	
amount	600	
load carrier	hardware box	
packaging method	upright	
packaging aid	steel strap, wooden cover plate	
331480	Socket Wrench SW 36, chrome-plated	
amount	1	
load carrier	loose	
packaging method	loose	
packaging aid		

Article No.	Article Name	Article Image
331490	Tension Rod Spanner DW20/26, galv.	
amount	1	
load carrier	loose	
packaging method	loose	
packaging aid		
331645	SK Anchor Cone DW 15	
amount	500	
load carrier	hardware box	
packaging method	loose	
packaging aid		
331646	SK Anchor Cone DW 20	
amount	250	
load carrier	hardware box	
packaging method	loose	
packaging aid	steel strap, wooden cover plate	
331647	SK Anchor Cone DW 26	
amount	250	
load carrier	hardware box	
packaging method	loose	
packaging aid	steel strap, wooden cover plate	
331655	DK Cone Remover UNI	
amount	1	
load carrier	loose	
packaging method	loose	
packaging aid		
408129	Tie Rod Spanner DW 15	
amount	1	
load carrier	loose	
packaging method	loose	
packaging aid		
410612	Tie Load Gauge 160 kN	
amount	1	
load carrier	case	
packaging method	loose	
packaging aid		

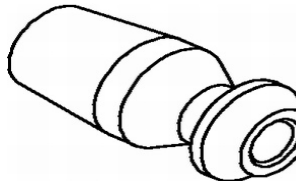
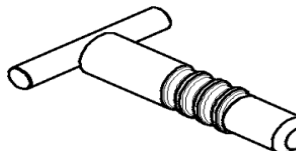
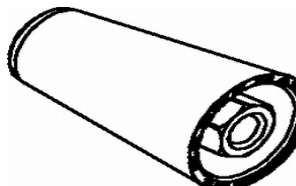
Article No.	Article Name	Article Image
414606	Arch. Mounting Cone M24	
amount	250	
load carrier	hardware box	
packaging method	loose	
packaging aid	steel strap, wooden cover plate	
415499	Leading Cone Screw DW 26	
amount	1	
load carrier	loose	
packaging method	loose	
packaging aid		
426609	SK Anchor Cone DW 15 / 2	
amount	500	
load carrier	hardware box	
packaging method	loose	
packaging aid	steel strap, wooden cover plate	

**The optimal
System for every
Project and every
Requirement**



Wall Formwork



Column Formwork



Slab Formwork



Climbing Systems



Bridge Formwork



Tunnel Formwork



Shoring Systems



Construction Scaffold



Facade Scaffold



Industrial Scaffold



Access



Protection Scaffold



Safety Systems



System-Free-Products



Services



**PERI SE
Formwork Scaffolding Engineering**

Rudolf-Diesel-Strasse 19
89264 Weissenhorn
Germany
Tel. +49 (0)7309.950-0
Fax +49 (0)7309.951-0
info@peri.com
www.peri.com